

3300 XL High Temperature Proximity System

Datasheet

Bently Nevada Machinery Condition Monitoring

141623 Rev. F



Description

Gas and steam turbines can produce temperatures hot enough to damage or destroy conventional proximity probes. The 3300 High Temperature Proximity System (HTPS) is designed to withstand the extreme temperatures found inside gas turbines, steam turbines and other types of rotating machinery. The HTPS measures vibration, thrust position, differential expansion and other parameters inside the hot areas of these machines. High temperature installations include:

- Near a labyrinth seal in steam turbines
- Differential expansion in steam turbines
- When probe cables are routed through struts that support the bearing housing of a gas turbine
- When probe cables are routed out through the exhaust path of a gas turbine
- Monitoring a troublesome bearing in a high temperature area
- Mode shape analysis at the mid-span location on steam and gas turbines for online machinery diagnostics
- Interstage radial and axial seal clearance measurements at the mid-span location of multi-stage steam turbines to minimize seal rubs
- Most hot bearing locations that can destroy conventional proximity probes

High temperature transducer with a rugged design

The 3300 XL High Temperature Proximity System can be used for proximity measurements at hot locations with excellent results. Customer benefits include:

- Proximity probe with integral hardline cable rated for +350°C (+662°F) continuous service in extreme conditions
- 4 mm (160 mils) of linear range for most measurements in the hot sections of the machine
- Hermetically-sealed ceramic probe tip seals out moisture and contaminants for added durability
- Ceramic tip and stainless steel construction resists heat, moisture and corrosion
- Threaded and smooth case styles for various types of probe mounting
- Hardline cable available in lengths of 1, 2 and 5 metres for routing cable through hot sections of the machine
- 3.94 V/mm (100 mV/mil) signal output compatible with virtually all new and existing Bently Nevada monitors and diagnostic equipment

Mode shape analysis

The 3300 XL High Temperature Proximity System is used to protect and manage critical machines in your facility for increased safety and efficiency. It is also used for mode shape analysis when measurements are taken at the turbine mid-span location. Mode shape analysis is important for research and development of a new steam or gas turbine design or when troubleshooting an existing design. Mode identification probes provide lateral mode shape information which is extremely valuable for balancing rotating machinery and identifying faults such as shaft cracks, bearing failures, rotor-to-stator rubs and other machine problems.

For test and measurement applications, the HTPS will meet or exceed most requirements for making proximity measurements in high

temperature environments. It is a viable option for your most challenging test problems.

The Bently Nevada 3300 XL High Temperature Proximity System is an advanced transducer designed for making proximity measurements at hot bearing locations in your machine. This transducer delivers dependable service in severe environments and is an ideal solution when using proximity probes at elevated temperatures.

Because of its thick hardline cable, the HTPS probe can be difficult to gap using a traditional threaded probe and bracket. Therefore, we recommend using smooth case probes, particularly if ordering a longer (2-metre or 5-metre) probe. The smooth case probes come with a clamp style mounting bracket to allow the probe to be gapped without turning.

Specifications

Unless otherwise noted, the following specifications are for a 3300 XL 16 mm HTPS Proximitor Sensor, matched extension cable and probe at 22 +4.4°C (72 +8°F), with a -24 Vdc power supply, a 10 kΩ load, a Bently Nevada supplied AISI 4140 steel target that is 31 mm (1.2 in) diameter or larger, and a probe gap of 2.5 mm (100 mils). The system accuracy and interchangeability specifications do not apply when using a transducer system calibrated to any target other than a Bently Nevada AISI 4140 steel target.

Electrical

Proximitor Sensor Input	Accepts one noncontacting 3300 XL HTPS 16 mm Proximity Probe with matched Extension Cable.
Power	Requires -19.6 Vdc to -26 Vdc at 12 mA maximum consumption. Operation at a more positive voltage than -23.5 Vdc can result in reduced linear range.
Supply Sensitivity	Less than 13 mV change in output voltage per volt change in input voltage.
Output resistance	50 Ω

Probe dc Resistance

Probe Length (m)	Resistance from the Center Conductor to the Outer Conductor (R _p PROBE) (ohms)
1.0	5.06
2.0	5.82
5.0	8.11

Extension Cable dc Resistance

Length of Extension Cable (m)	Resistance from Center Conductor to Center Conductor	Resistance from Coaxial Conductor

	(RCORE) (ohms)	to Coaxial Conductor (r _{jacket}) (ohms)
4.0	0.88	0.26
7.0	1.62	0.49
8.0	1.84	0.55

Extension cable capacitance	69.9 pF/m (21.3 pF/ft) typical
Field wiring	Maximum length of 305 metres (1,000 feet) between the 3300 XL HTPS Proximitor Sensor and the monitor. See the frequency response graph for signal rolloff at high frequencies when using longer field wiring lengths.
Linear Range	4.0 mm (160 mils). Linear range begins at approximately 0.5 mm (20 mils) from target and is from 0.5 to 4.5 mm (20 to 180 mils) (approximately -2 to -18 Vdc).
Recommended Gap Setting	2.5 mm (100 mils)
Incremental Scale Factor (ISF)	3.94 V/mm (100 mV/mil) ±9.65% including interchangeability error when measured in increments of 0.5 mm (20 mils) over the 4.0 mm (160 mil) linear range.
Deviation from best fit straight line (DSL)	Less than ±78 xm (±3.1 mils).

System performance over extended temperatures	Over a probe temperature range of 22°C to +350°C (72°F to +662°F) the ISF remains within ±30% of 3.94 V/mm (100 mV/mil), the DSL remains within ±0.51 mm (±20 mils).
Frequency Response	0 to 6 kHz: +0, -3 dB typical, with up to 305 metres (1000 feet) of field wiring.
Recommended Minimum Target Size	30.5 mm (1.2 in) diameter (flat target)
Recommended Minimum Shaft Diameter	152 mm (6.0 in)

 Measurements on shaft diameters smaller than 76 mm (3.0 in) usually require close spacing of radial vibration or axial position transducers with the potential for their electromagnetic emitted fields to interact with one another (cross talk), resulting in erroneous readings. Care should be taken to maintain minimum separation of transducer tips, generally at least 64 mm (2.5 in) for dual axial position measurements or 54 mm (2.1 in) for radial vibration measurements to prevent cross talk. Radial vibration or position measurements on shaft diameters smaller than 152 mm (6.0 in) will generally result in a change in scale factor due to the curvature of the shaft surface. Consult Performance Specification 159132 for additional information.

Effects of 60 Hz Magnetic Fields Up to 300 Gauss			
Output voltage in mil pp/gauss			
Gap	Proximator	Probe	Ext. Cable

Effects of 60 Hz Magnetic Fields Up to 300 Gauss			
	Sensor		
0.5 mm (20 mil)	0.0020	0.0030	0.0011
2.5 mm (100 mil)	0.0042	0.0034	0.0046
4.5 mm (180 mil)	0.0096	0.0070	0.0157
Electrical Classification		Complies with the European CE mark.	

Mechanical

Probe Tip Material	Ceramic
Probe Case Material	AISI 316L stainless steel (SST).
Probe Cable	1, 2 or 5 metre length of AISI 304L SST hardline cable.
Extension Cable Material	75 Q triaxial, fluoroethylene propylene (FEP) insulated.
Proximator Sensor Material	Aluminum with epoxy powder coat finish.
System Length	9 metres including extension cable
Extension Cable Armor (optional)	Flexible AISI 302 SST with FEP outer jacket.
Tensile Strength (maximum rated)	289 N (65 pounds) probe to extension cable.
Connector material	Stainless steel
Probe case torque (maximum rated)	81 N.m (720 in.lb)

Connector-to-connector Torque

Recommended torque	Finger tight + 1/8 turn
Maximum torque	0.565 N.m (5 in.lb)
Minimum Bend Radius (with or without SST armor)	25.4 mm (1.0 in)
System Weight (typical)	
Probe	117 g/m (1.26 oz/ft) of hardline cable + 12 g/cm (1.07 oz/in) of case
Extension Cable	45 g/m (0.5 oz/ft)
Armored Extension Cable	140 g/m (1.5 oz/ft)
Proximator Sensor	255 g (9 oz)

Extension Cable and Proximator Sensor Relative Humidity	100% condensing, non-submerged when connectors are protected.
Probe Pressure	3300 XL High Temperature Probes are designed to seal differential pressure between the probe tip and case. Probes are not pressure tested prior to shipment. Contact our custom design department if you require a test of the pressure seal for your application.

Environmental Limit:

Probe Temperature Range

Operating and Storage Temperature	-34°C to +350°C (-30°F to +662°F)
-----------------------------------	-----------------------------------

Extension Cable Temperature Range

Operating and Storage Temperature	-52°C to +177°C (-60°F to +351°F)
-----------------------------------	-----------------------------------

Proximator Sensor Temperature Range

Operating Temperature	-52°C to +100°C (-60°F to +212°F)
Storage Temperature	-52°C to +105°C (-60°F to +221°F)
Probe Relative Humidity	100% condensing, submersible when connectors are protected.

 It is the responsibility of the customer or user to ensure that all liquids and gases are contained and safely controlled should leakage occur from a proximity probe. In addition, solutions with high or low pH values may erode the tip assembly of the probe causing media leakage into surrounding areas. Bently Nevada will not be held responsible for any damages resulting from leaking 3300 high temperature proximity probes. In addition, 3300 XL High Temperature Proximity probes will not be replaced under the service plan due to probe leakage.

Compliance and Certifications

FCC

This device complies with part 15 of the FCC Rules. Operation is subject to the following two conditions:

- This device may not cause harmful interference.
- This device must accept any interference received, including interference that may cause undesired operation.

RoHS

RoHS Directive 2011/65/EU

Ordering Information

 For the detailed listing of country and product specific approvals, refer to the *Approvals Quick Reference Guide* (108M1756) available from Bently.com.

3300 XL High Temperature Probe, 3/4-16 UNF threads

330301-AAA-BBB-CC-DD-EE-FF

A: Unthreaded Length Option

 Unthreaded length must be at least 1.1 inch less than the case length.

Order in increments of 0.1 in

Length configurations

Maximum unthreaded length	5.4 in
Minimum unthreaded length	0.0 in
Example	012 = 1.2 in

B: Overall Case Length Option:

Order in increments of 0.1 in

Threaded length configurations

Maximum case length	6.5 in
Minimum case length	1.1 in
Example	060 = 6.0 in

C: Hardline Length Option:

10	1.0 metre (3.3 feet)
20	2.0 metres (6.6 feet)
50	5.0 metres (16.4 feet)

D: Total Length Option:

 Note: Extension cable is included with the proximity probe.

90	9.0 metres (30 feet)
-----------	----------------------

E: Extension Cable Armor Option:

00	Without stainless steel armor
01	With stainless steel armor

F: Agency Approval Option:

00	Not required
-----------	--------------

3300 XL High Temperature Probe, M18 x 1.5 threads

330302-AAA-BBB-CC-DD-EE-FF

A: Unthreaded Length Option:

 Unthreaded length must be at least 30 mm less than the case length.

Order in increments of 10 mm

Length configurations

Maximum unthreaded length	130mm
Minimum unthreaded length	0.0 mm
Example	050 = 50 mm

B: Overall Case Length Option:

Order in increments of 10 mm

Threaded length configurations

Maximum case length	160 mm
Minimum case length	30 mm
Example	130 = 130 mm

C: Hardline Length Option:

10	1.0 metre (3.3 feet)
20	2.0 metres (6.6 feet)
50	5.0 metres (16.4 feet)

D: Total Length Option:

 Extension cable is included with the proximity probe.

90	9.0 metres (30 feet)
-----------	----------------------

E: Extension Cable Armor Option:

00	Without stainless steel armor
01	With stainless steel armor

F: Agency Approval Option:

00	Not required
-----------	--------------

3300 XL High Temperature Probe, Smooth Case

330303-AAA-BB-CC-DD-EE

A: Overall Case Length Option:

 Mounting bracket is included with the proximity probe.

Order in increments of 0.1 in (2.54 mm)

Threaded length configurations

Maximum case length	9.9 in (251.5 mm)
Minimum case length	0.6 in (15.2 mm)
Example	0 6 0 = 6.0 in (152.4 mm)

B: Hardline Length Option:

10	1.0 metre (3.3 feet)
20	2.0 metres (6.6 feet)
50	5.0 metres (16.4 feet)

C: Total Length Option:

 Extension cable is included with the proximity probe.

90	9.0 metres (30 feet)
-----------	----------------------

D: Extension Cable Armor Option:

00	Without stainless steel armor
01	With stainless steel armor

E: Agency Approval Option:

00	Not required
-----------	--------------

3300 XL 16mm High Temperature Proximator Sensor

330380-AA-BB (replaced 330300)

A: Total Length and Mounting Option

 Extension cable is included with the proximity probe.

90	9 meter, panel mount
91	9 meter, DIN mount
92	9 meter, no mounting hardware

B: Agency Approval

00	Not required
-----------	--------------

Accessories

125M6030	3300 XL 16mm High Temperature Proximity System User Guide
159132	Performance Specification
134835-01	Mounting bracket for 330303 smooth case probe (spare).

Spare Extension Cable

330330-AAA-BB-CC

A: Cable Length Option:

 Extension cable is already included with the proximity probe. This is a matched spare cable only.

040	4.0 metres (13.1 feet)
070	7.0 metres (23.0 feet)
080	8.0 metres (26.3 feet)

B: Armor Option:

00	Without stainless steel armor
-----------	-------------------------------

01	With stainless steel armor
C: Agency Approval Option:	
00	Not required
Armor Length	
Cable Length Option	Armor Length ± 0.05 m (0.17 ft)
040	1.9 metres (6.25 ft)
070	5.6 metres (18.4 ft)
080	6.6 metres (21.7 ft)

Field Wiring Cable

132501-AA

1.0 mm² (18 AWG), 3 conductor twisted, shielded cable for connections between Proximitor sensor and monitor. Terminal ring lugs are installed at each end, including an extra shield ring lug at the monitor end.

A: Cable Length Option in Feet:

Order in increments of 1.0 foot (0.3 metres)

Minimum length	2 feet (0.6 metres)
Maximum length	99 feet (30 metres)
Example	15 = 15 feet (4.6 metres)

Graphs and Figures

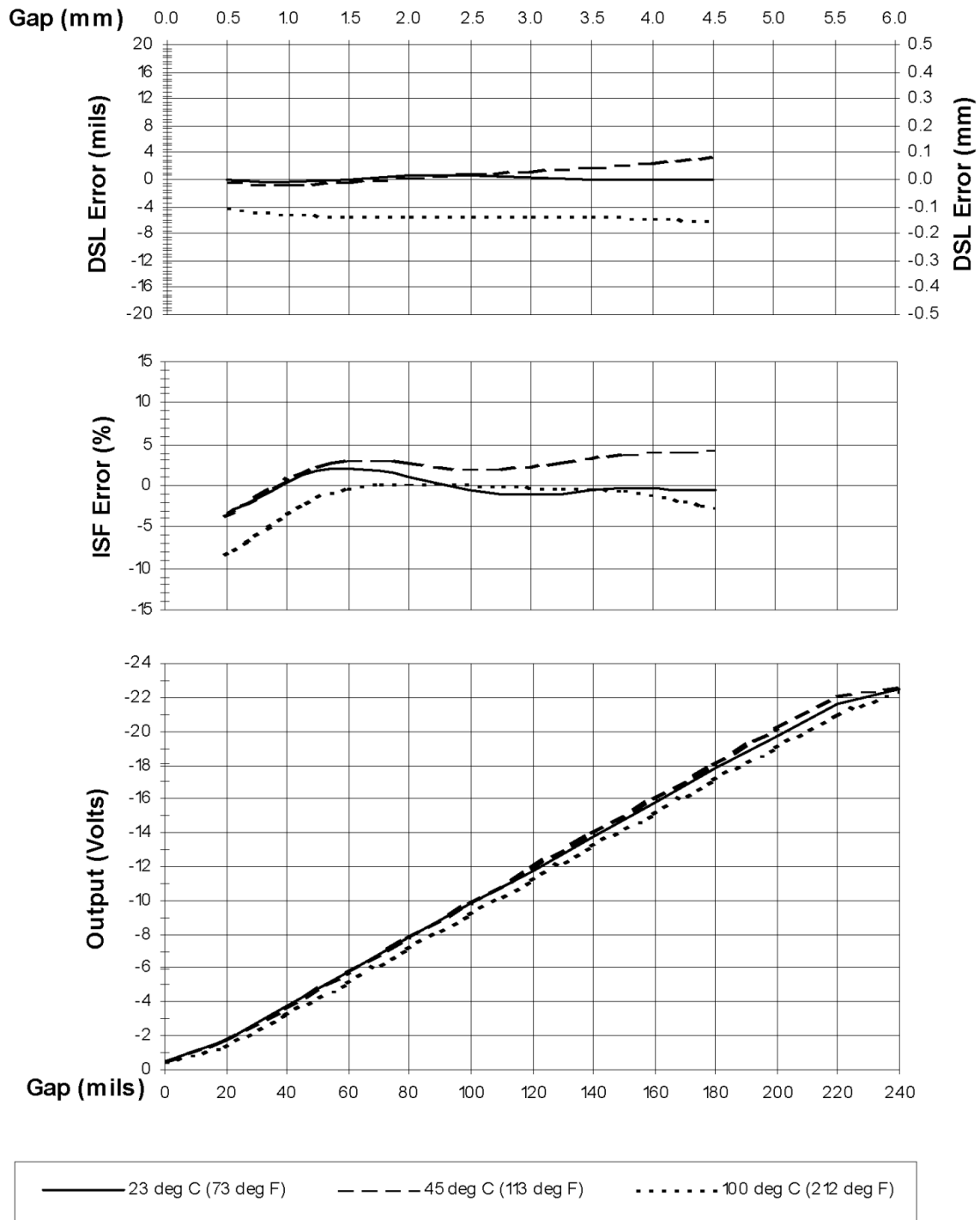

Figure 1: Typical 3300 XL HTPS Performance with System at High Temperature

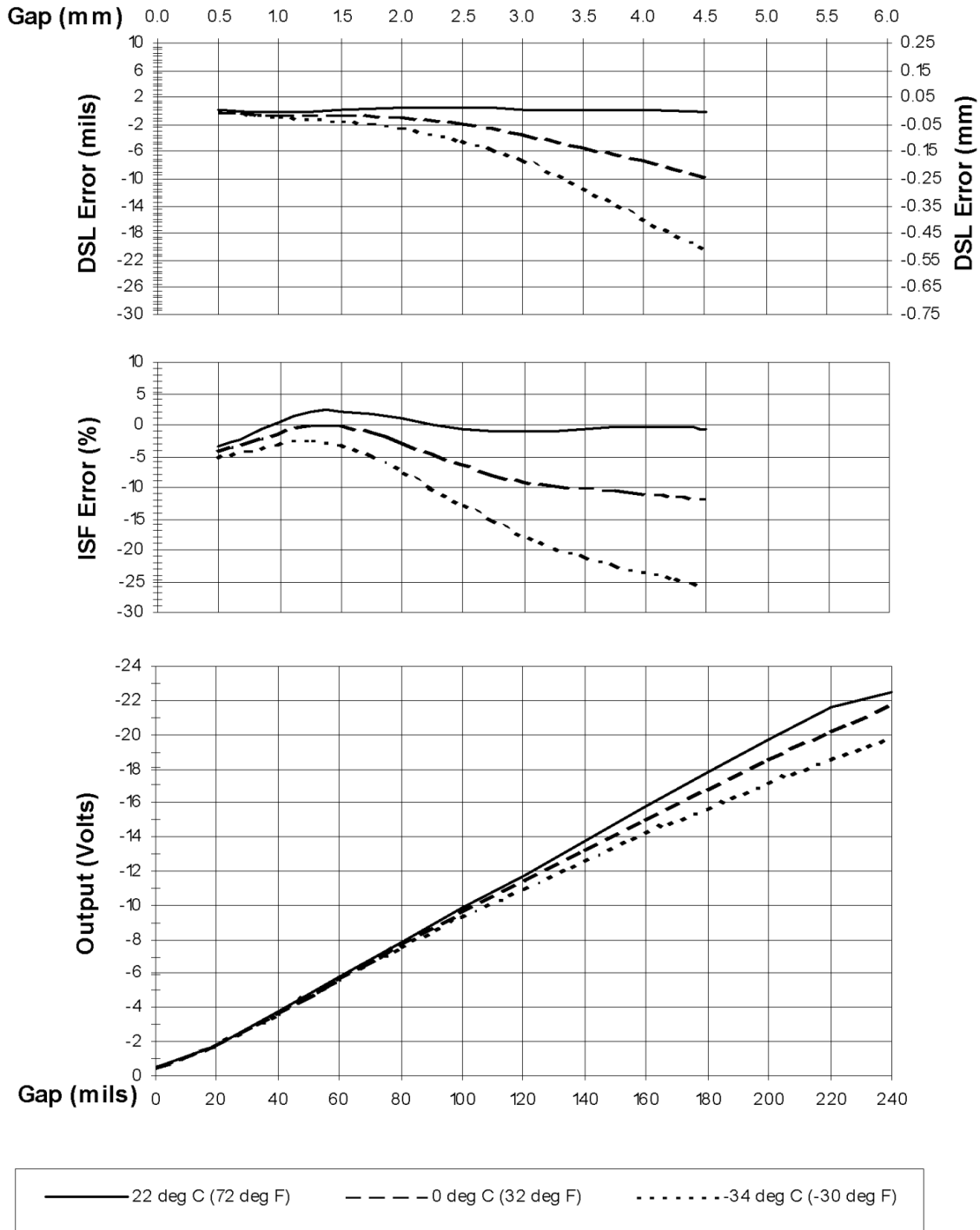

Figure 2: Typical 3300 XL HTPS Performance with System at Low Temperature

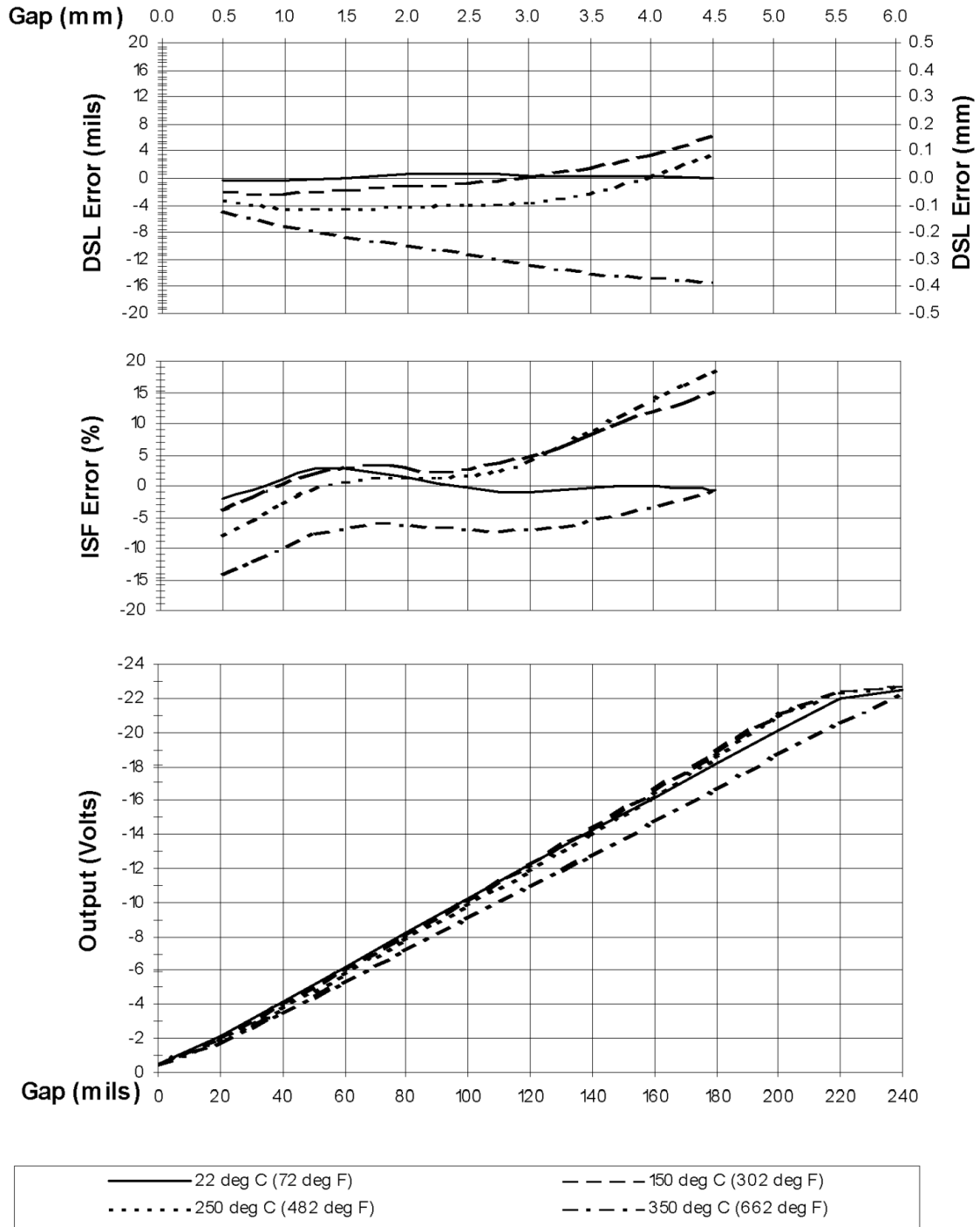

Figure 3: Typical 3300 XL HTPS Performance with Probe at High Temperature

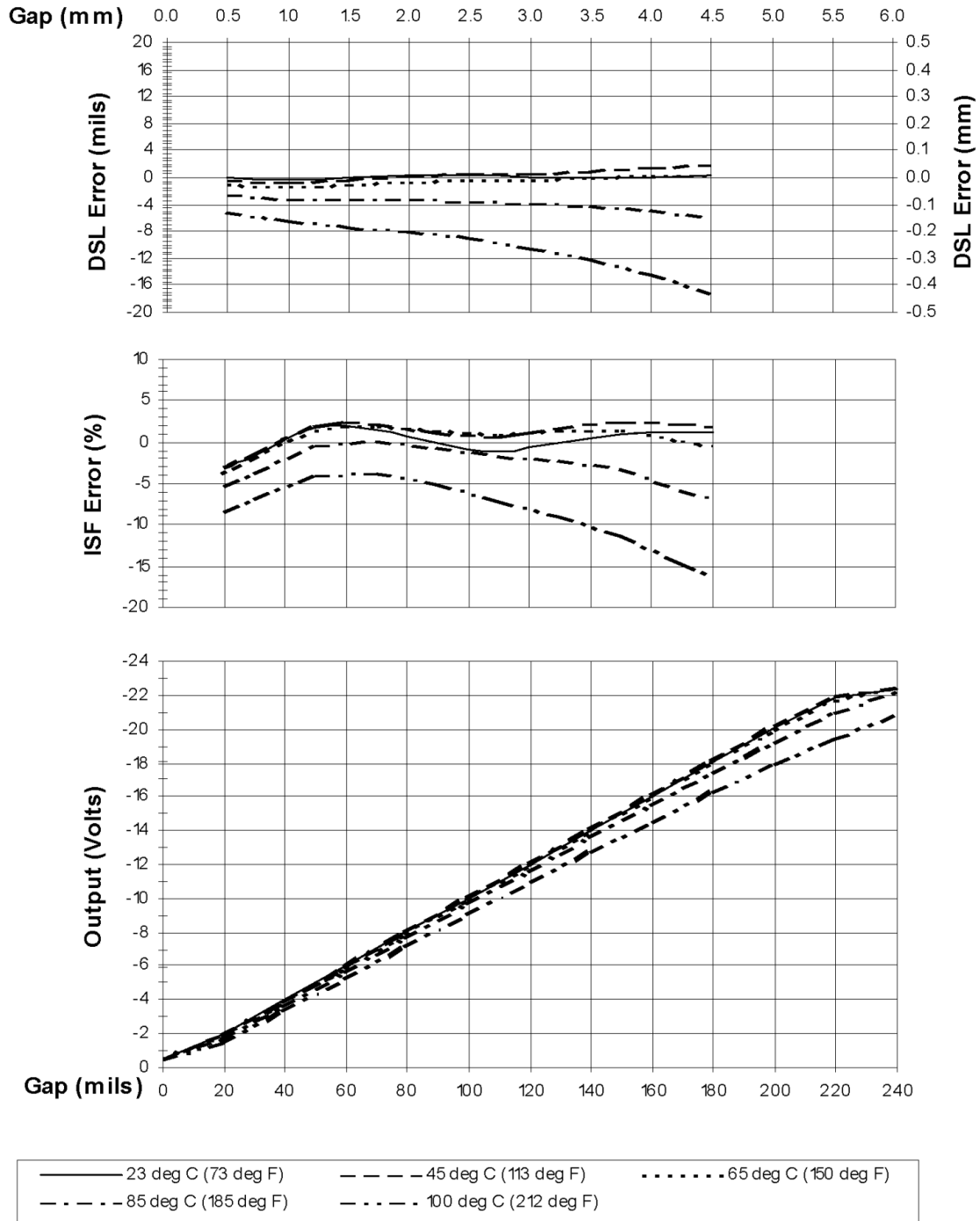

Figure 4: Typical 3300 XL HTPS Performance with Proximitor Sensor at High Temperature

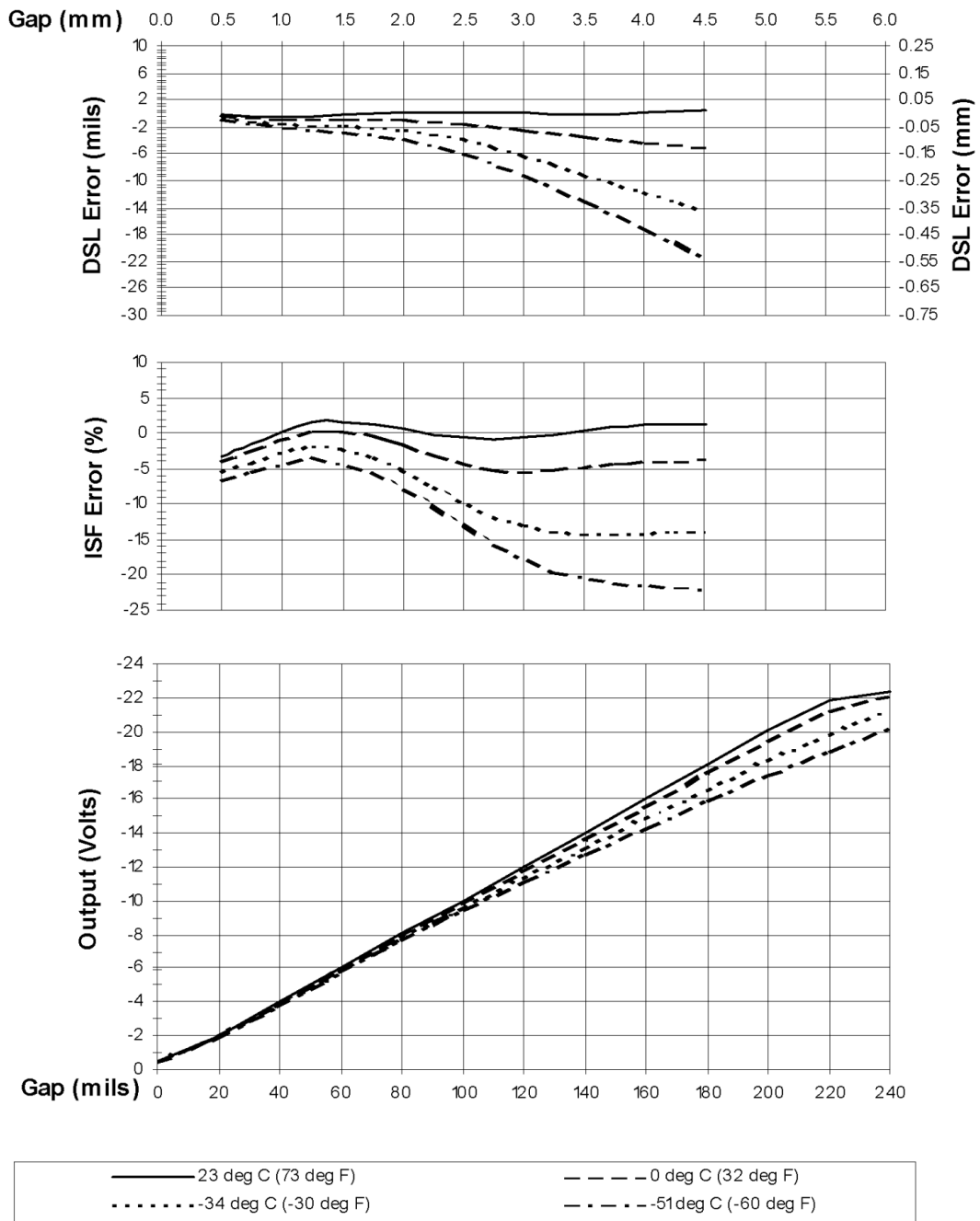

Figure 5: Typical 3300 XL HTPS Performance with Proximity Sensor at Low Temperature

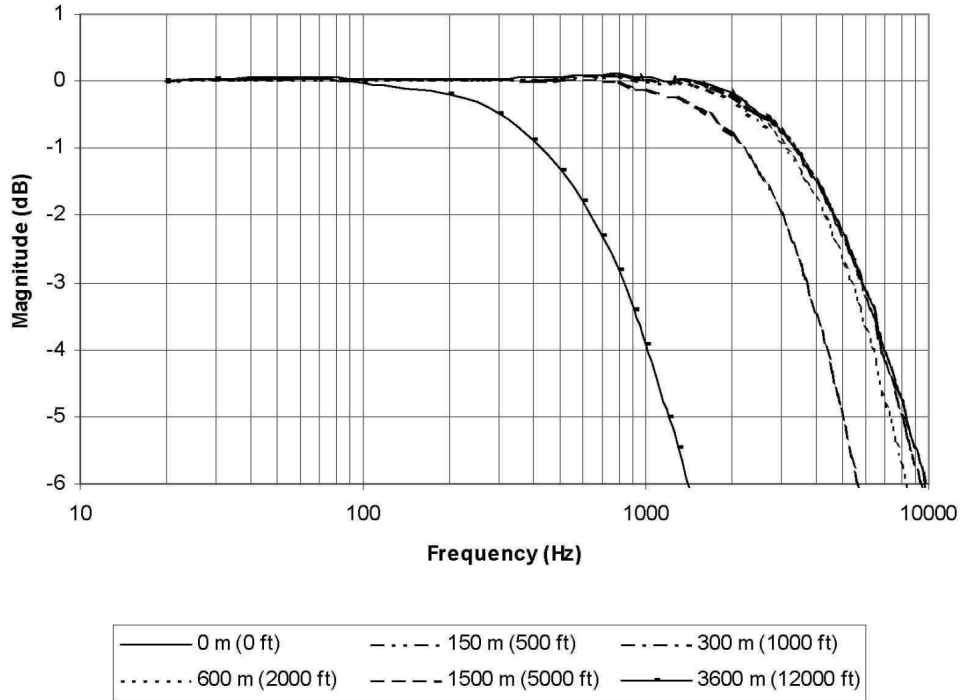

Figure 6: Typical 3300 XL HTPS Amplitude Frequency Response with Cable Attached

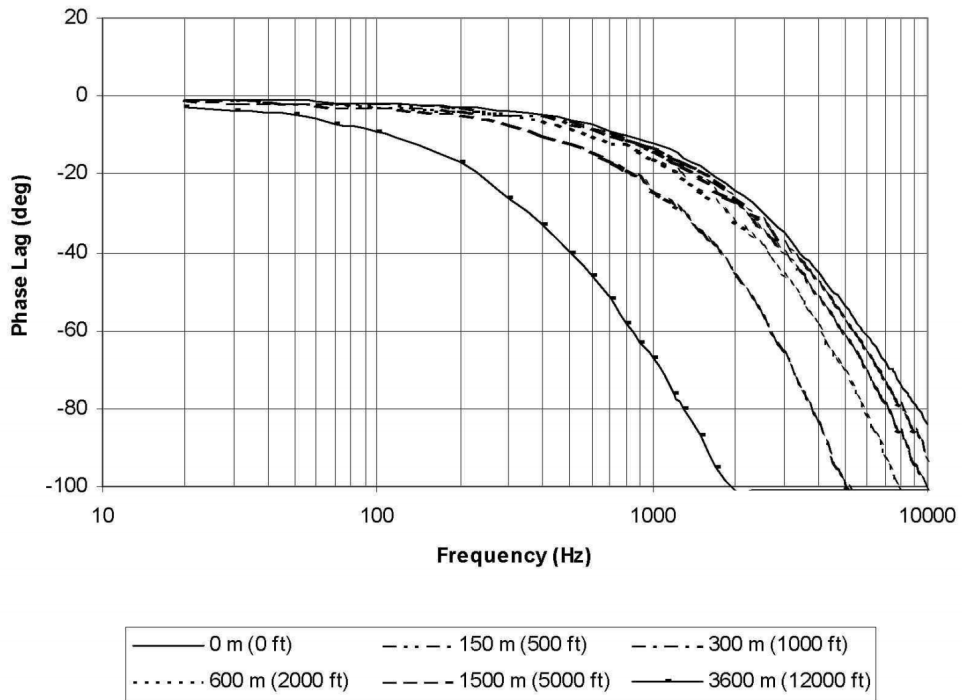

Figure 7: Typical 3300 XL HTPS Phase Frequency Response with Cable Attached

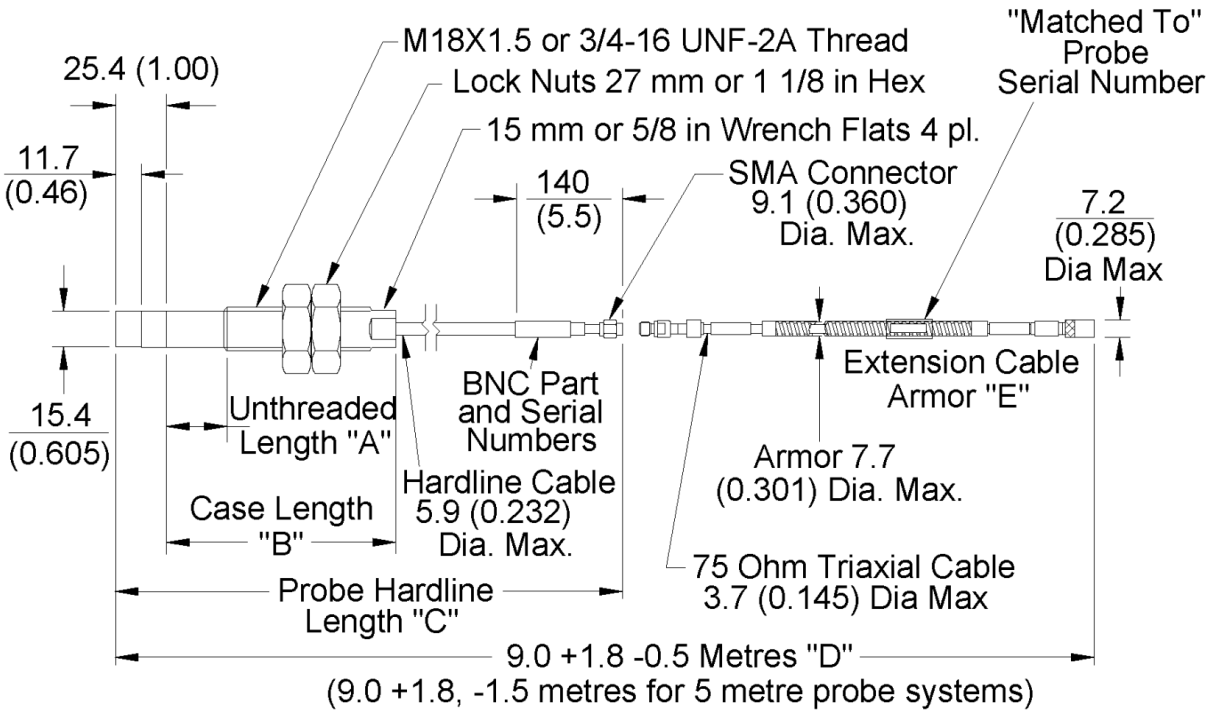

Figure 8: 330301 and 330302 HTPS Probe, English and Metric Threaded Versions

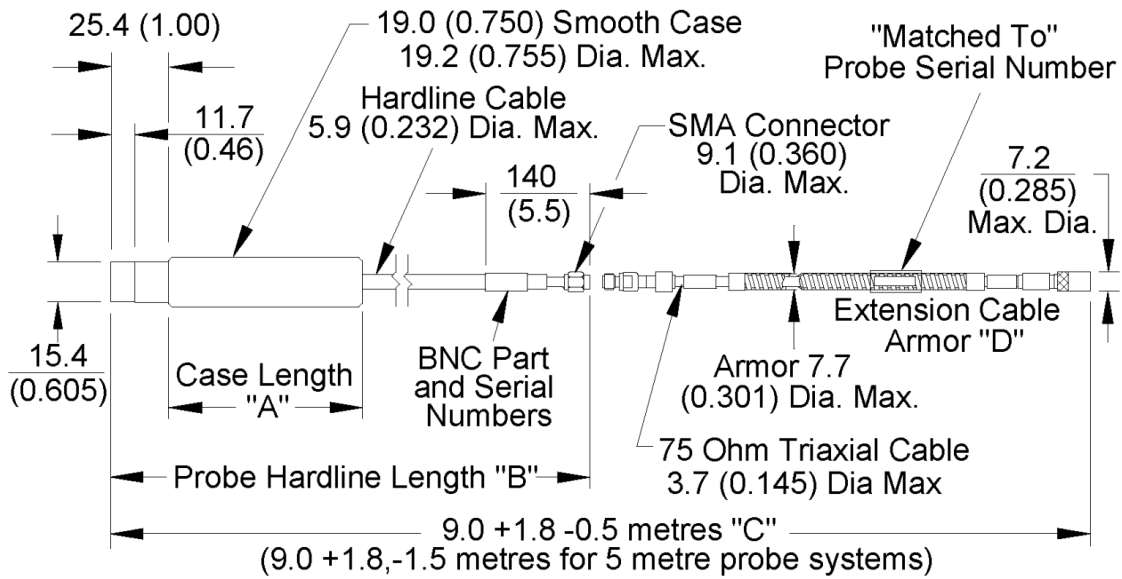

Figure 9: 330303 HTPS Smooth Case Probe

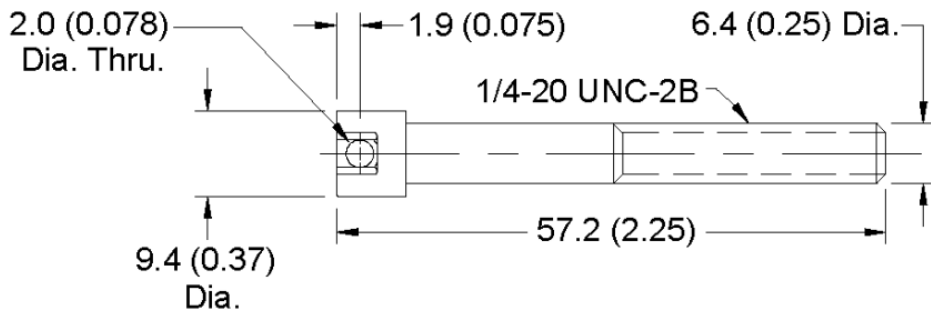
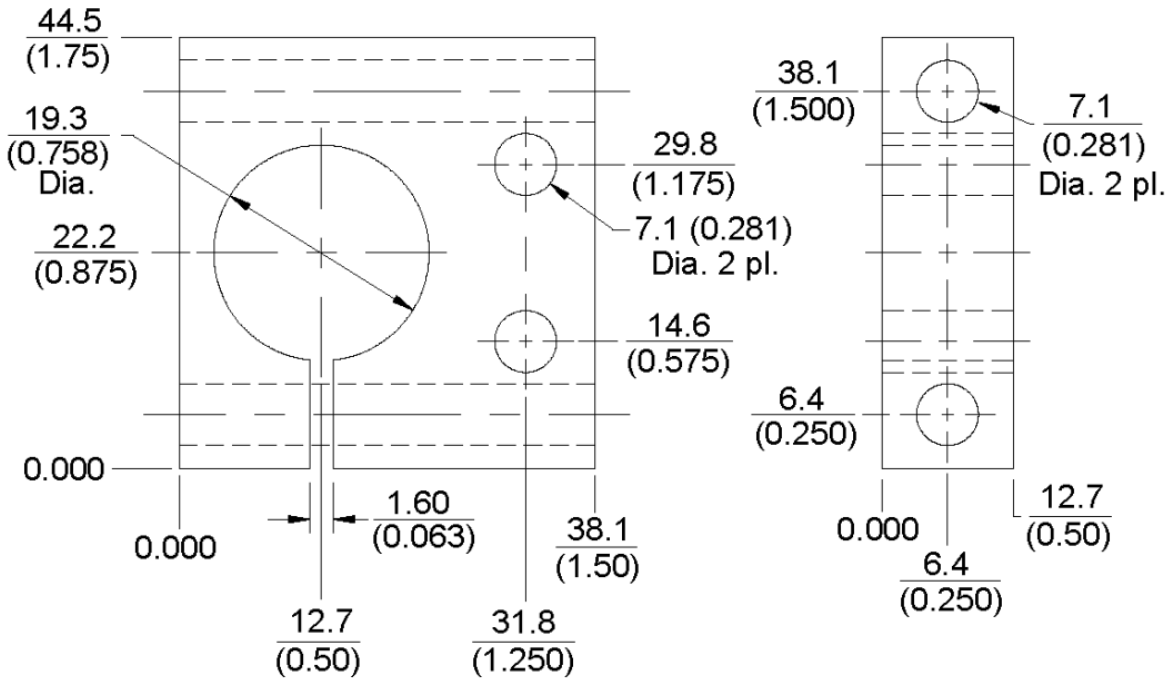

Figure 10: Mounting Clamp for 330303 Smooth Case Probe

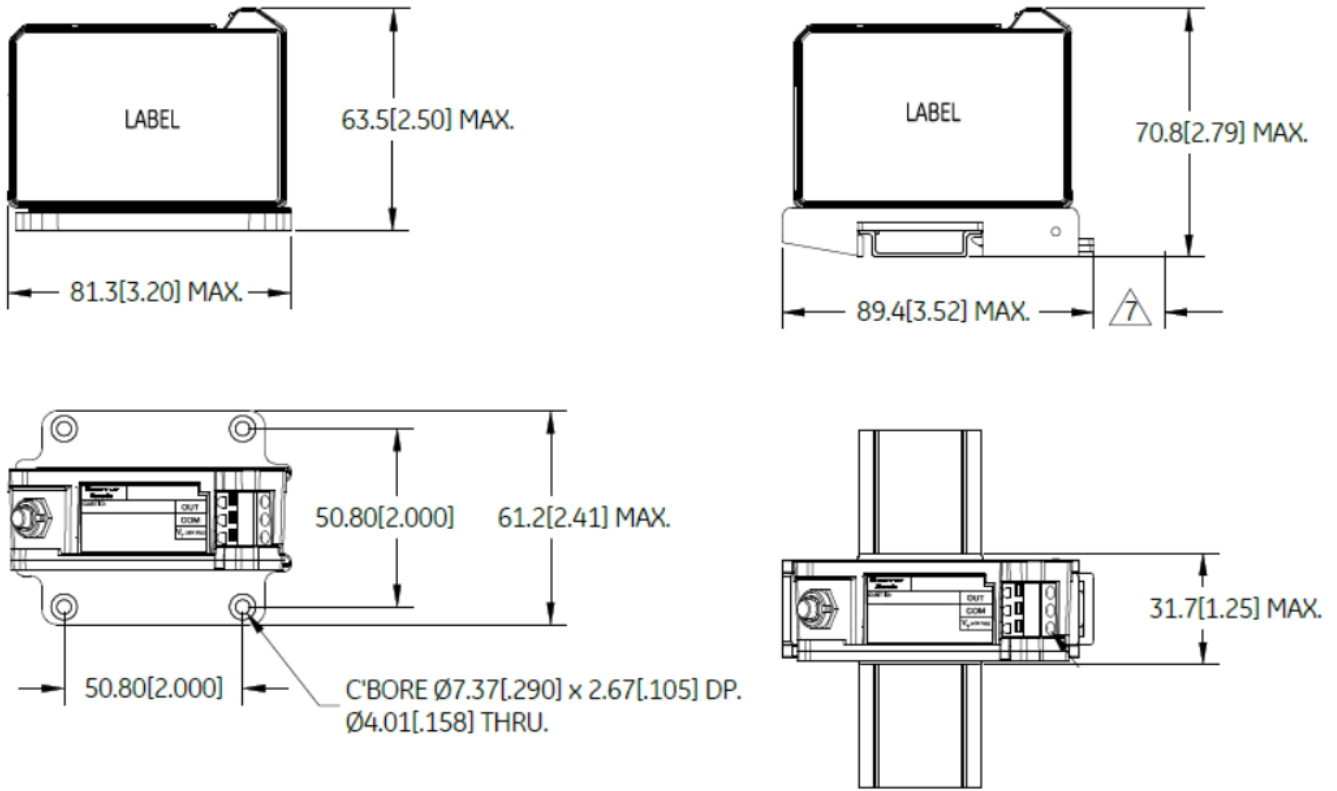

Figure 11: 330380 HTPS Proximito Sensor (see drawing of same number)

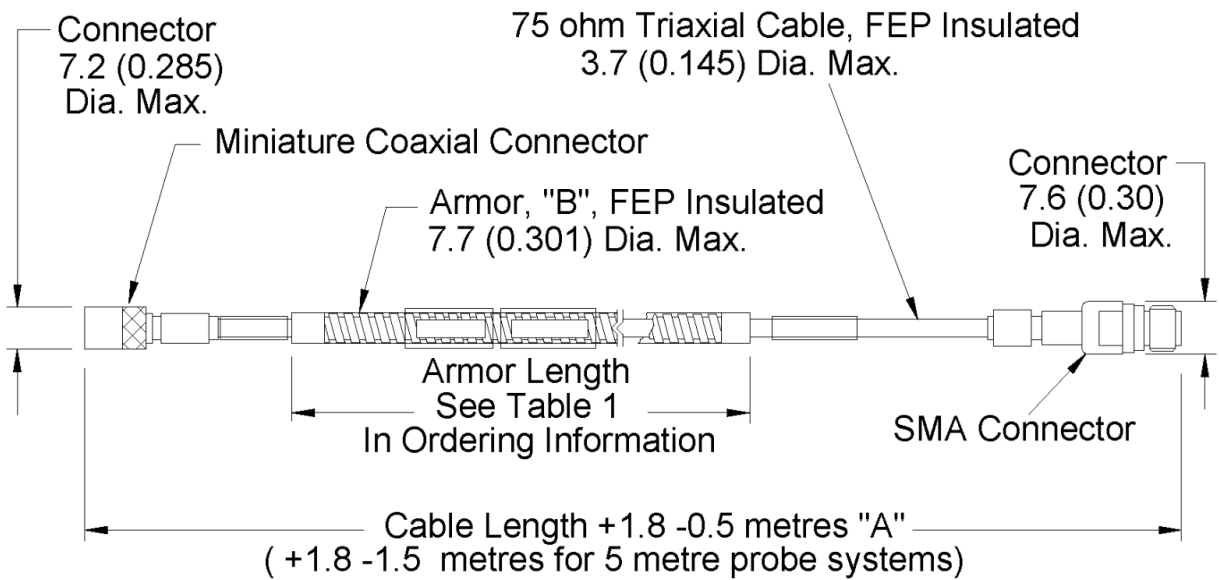

Figure 12: Spare Extension Cable, Part Number 330330

Notes:

1. All dimensions on figures are in millimetres (inches) unless otherwise noted.
2. Letters inside quotation marks on figures refer to probe ordering options.
3. Stainless steel armor is supplied with FEP outer jacket.

Copyright 2020 Baker Hughes Company. All rights reserved.



Bently Nevada, Orbit Logo and Proximitor are registered trademarks of Bently Nevada, a Baker Hughes Business, in the United States and other countries. The Baker Hughes logo is a trademark of Baker Hughes Company. All other product and company names are trademarks of their respective holders. Use of the trademarks does not imply any affiliation with or endorsement by the respective holders.

Baker Hughes provides this information on an "as is" basis for general information purposes. Baker Hughes does not make any representation as to the accuracy or completeness of the information and makes no warranties of any kind, specific, implied or oral, to the fullest extent permissible by law, including those of merchantability and fitness for a particular purpose or use. Baker Hughes hereby disclaims any and all liability for any direct, indirect, consequential or special damages, claims for lost profits, or third party claims arising from the use of the information, whether a claim is asserted in contract, tort, or otherwise. Baker Hughes reserves the right to make changes in specifications and features shown herein, or discontinue the product described at any time without notice or obligation. Contact your Baker Hughes representative for the most current information.

The information contained in this document is the property of Baker Hughes and its affiliates; and is subject to change without prior notice. It is being supplied as a service to our customers and may not be altered or its content repackaged without the express written consent of Baker Hughes. This product or associated products may be covered by one or more patents. See [Bentley.com/legal](https://www.bentley.com/legal).

1631 Bently Parkway South, Minden, Nevada USA 89423
Phone: 1.775.782.3611 or 1.800.227.5514 (US only)
[Bentley.com](https://www.bentley.com)