

Masoneilan™

SVI™ 3

Digital Positioner

Quick Start Guide (Rev. A)



THESE INSTRUCTIONS PROVIDE THE CUSTOMER/OPERATOR WITH IMPORTANT PROJECT-SPECIFIC REFERENCE INFORMATION IN ADDITION TO THE CUSTOMER/OPERATOR'S NORMAL OPERATION AND MAINTENANCE PROCEDURES. SINCE OPERATION AND MAINTENANCE PHILOSOPHIES VARY, BAKER HUGHES COMPANY (AND ITS SUBSIDIARIES AND AFFILIATES) DOES NOT ATTEMPT TO DICTATE SPECIFIC PROCEDURES, BUT TO PROVIDE BASIC LIMITATIONS AND REQUIREMENTS CREATED BY THE TYPE OF EQUIPMENT PROVIDED.

THESE INSTRUCTIONS ASSUME THAT OPERATORS ALREADY HAVE A GENERAL UNDERSTANDING OF THE REQUIREMENTS FOR SAFE OPERATION OF MECHANICAL AND ELECTRICAL EQUIPMENT IN POTENTIALLY HAZARDOUS ENVIRONMENTS. THEREFORE, THESE INSTRUCTIONS SHOULD BE INTERPRETED AND APPLIED IN CONJUNCTION WITH THE SAFETY RULES AND REGULATIONS APPLICABLE AT THE SITE AND THE PARTICULAR REQUIREMENTS FOR OPERATION OF OTHER EQUIPMENT AT THE SITE.

THESE INSTRUCTIONS DO NOT PURPORT TO COVER ALL DETAILS OR VARIATIONS IN EQUIPMENT NOR TO PROVIDE FOR EVERY POSSIBLE CONTINGENCY TO BE MET IN CONNECTION WITH INSTALLATION, OPERATION OR MAINTENANCE. SHOULD FURTHER INFORMATION BE DESIRED OR SHOULD PARTICULAR PROBLEMS ARISE WHICH ARE NOT COVERED SUFFICIENTLY FOR THE CUSTOMER/OPERATOR'S PURPOSES THE MATTER SHOULD BE REFERRED TO BAKER HUGHES.

THE RIGHTS, OBLIGATIONS AND LIABILITIES OF BAKER HUGHES AND THE CUSTOMER/OPERATOR ARE STRICTLY LIMITED TO THOSE EXPRESSLY PROVIDED IN THE CONTRACT RELATING TO THE SUPPLY OF THE EQUIPMENT. NO ADDITIONAL REPRESENTATIONS OR WARRANTIES BY BAKER HUGHES REGARDING THE EQUIPMENT OR ITS USE ARE GIVEN OR IMPLIED BY THE ISSUE OF THESE INSTRUCTIONS.

THESE INSTRUCTIONS ARE FURNISHED TO THE CUSTOMER/OPERATOR SOLELY TO ASSIST IN THE INSTALLATION, TESTING, OPERATION, AND/OR MAINTENANCE OF THE EQUIPMENT DESCRIBED. THIS DOCUMENT SHALL NOT BE REPRODUCED IN WHOLE OR IN PART WITHOUT THE WRITTEN APPROVAL OF BAKER HUGHES.

Contents

Safety Information	4
Introduction.....	5
Mounting Procedure of SVI3 on Rotary Control Valves.....	6-8
Mounting Procedure of SVI3 on Reciprocating Control Valves	9-11
Tubing and Air Supply to SVI3.....	12
SVI3 Wiring Procedure	13-14
Local Commissioning with Pushbuttons and Local Display.....	15-16
Remote Commissioning with DTM Based ValVue 3	17-18
Commissioning with Handheld Communicator.....	19-21

Safety Information

Important – Please Read Before Installation

These Instructions contain DANGER, WARNING, and CAUTION labels, where necessary, to alert you to safety related or other important information. Read the instructions carefully before installing and maintaining your desuperheater. DANGER and WARNING hazards are related to personal injury. CAUTION hazards involve equipment or property damage. Operation of damaged equipment can, under certain operational conditions, result in degraded process system performance that can lead to injury or death. Total compliance with all DANGER, WARNING, and CAUTION notices is required for safe operation.



This is the safety alert symbol. It alerts you to potential personal injury hazards. Obey all safety messages that follow this symbol to avoid possible injury or death.



Indicates a potentially hazardous situation which, if not avoided, could result in death or serious injury.



Indicates a potentially hazardous situation which, if not avoided, could result in serious injury.



Indicates a potentially hazardous situation which, if not avoided, could result in minor or moderate injury.



When used without the safety alert symbol indicates a potentially hazardous situation which, if not avoided, could result in property damage.

Note: Indicates important facts and conditions.

Introduction

The third generation Baker Hughes Masoneilan SVI is a user friendly digital valve positioner for pneumatic control valves. Utilizing advanced control and diagnostic algorithms, along with field-proven noncontact position sensing technology, the SVI delivers accurate, responsive and reliable positioning performance.



Figure 1 - SVI3 Digital Positioner

Note:

Refer to <https://valves.bakerhughes.com/resource-center> for the following:

- Free trial of ValVue3 and SVI3 DTM software (mentioned in Section 7)
- ValVue3 and SVI3 DTM Installation Manual
- SVI3 Digital Positioner Instruction and Operational Manual (IOM) for detailed operation of SVI3

WARNING

Refer to ES-817 for special instructions for installing Masoneilan SVI3 unit in areas where there is a potential for explosive gas atmosphere or inflammable dust.

Mounting Procedure of SVI3 on Rotary Control Valves

This section describes the procedure for mounting the SVI3 on rotary control valves that have less than 60° rotation, such as the *Camflex™*.

Tools required:

- 3/16" Hex Key
- 5/32" Hex Key
- 3mm, 4mm, 5mm Hex Key



Figure 2 - SVI3 Mounted on Camflex Valve

1. Attach the SVI3 rotary mounting bracket to the valve actuator with two 5/16 - 18 UNC flat-head cap screws and tighten using 3/16" Hex Key as shown in Figure 3. Always position the long end of the bracket towards the gauges of the positioner to provide a horizontal SVI installation.

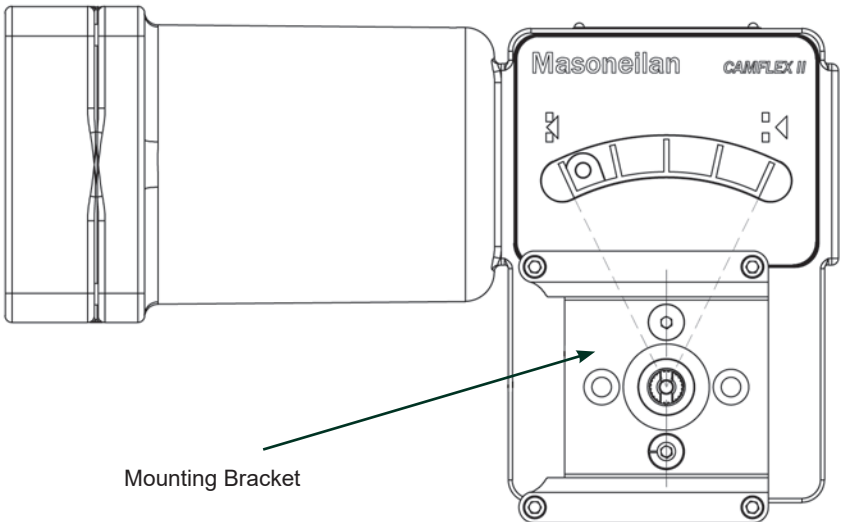



Figure 3 - Camflex Mounting Bracket

2. By referring to Figure 4, perform the following actions:

Step 1 - Secure extension shaft to actuator shaft with 1/4" - 28 UNF socket flat-head screw and tighten using 5/32" Hex Key with a torque of 144 in-lbs (16.269 N-m).

Steps 2 & 3 - Secure the magnet holder with two M3 set screws and tighten using 3mm Hex Key (Step 3 in Figure 4 shows only 1 of 2 screws). Rotate the magnet holder so that the magnet axis is as per the specification in Table 1.

Table 1. Travel Sensor Alignment

Rotary Mounting System	Stroke Direction	Magnet Orientation	Valve Position	Sensor Counts
Rotary <60°	<60° rotation clockwise or counter clockwise rotation		Closed (0%)	0 +/- 1000
General rule for configurations >60° ⁽¹⁾	Any amount of rotation clockwise or counter clockwise		50% Travel (mid-stroke)	0 +/- 1000

1. For applications >60° rotation, use air regulator plumbed directly to actuator and increase pressure to set valve to 50% or mid-stroke prior to orienting magnet holder.

Step 4 - With the M6 magnet holder screws snug, verify that there will be no interference with the magnet holder and the SVI sensor cavity by placing a flat object (like a wrench as shown) across the top surface of the bracket. Adjust height as necessary to make sure the magnet assembly is flush with the top of the mounting bracket. Wrench tight the two M6 screws on the magnet holder to lock the position in place.

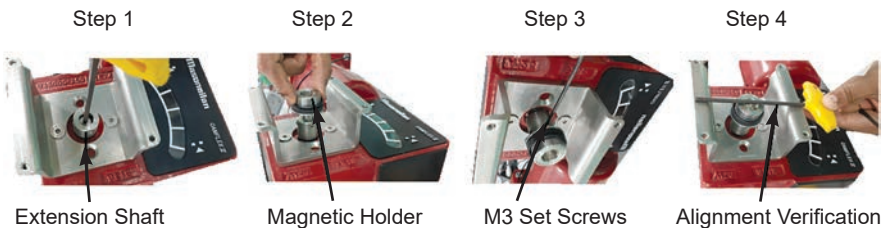

Figure 4 - Mounting Kit Assembly Procedure on Rotary Valve

- Secure the SVI3 onto the mounting bracket using four M6 x 20 mm socket head cap screws using 6mm Hex Key.

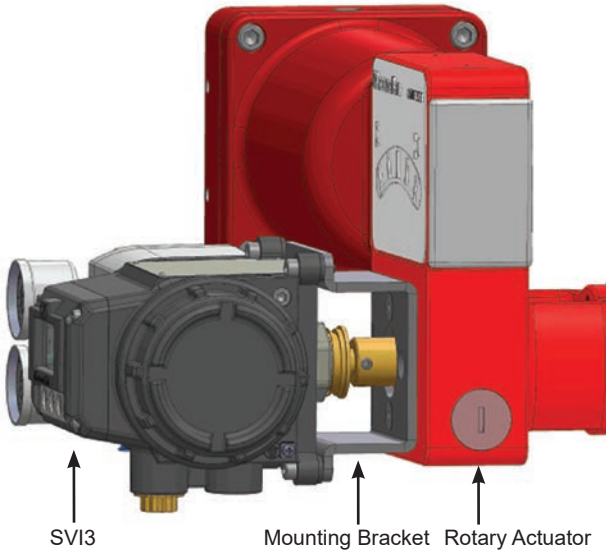

Figure 5 - Camflex with Mounting Bracket (side view)

- Ensure that the V-Seal makes contact with the skirt around the alignment ring on the SVI3.

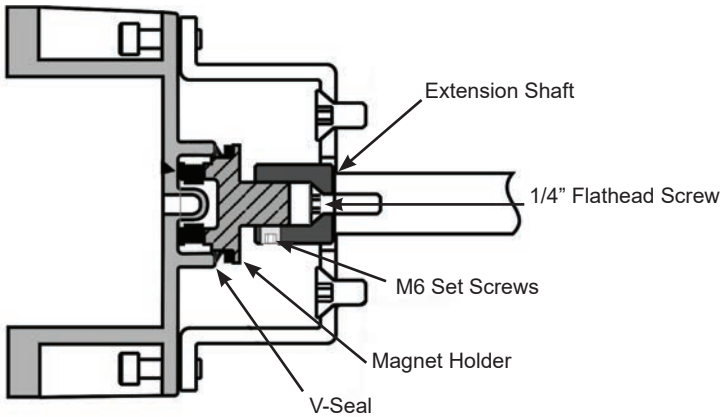

Figure 6 - Camflex V-Seal

Mounting Procedure of SVI3 on Reciprocating Control Valves

This section describes the procedure for mounting the SVI3 on Reciprocating Valves, using Masoneilan's 87/88 Multi-Spring actuator.

Tools required:

- 7/16" Combination Wrench (2 required)
- 3/8" Combination Wrench
- 1/2" Combination Wrench
- Phillips Head Screw Driver
- 4mm, 5mm, 6mm Hex Key



Figure 7 - SVI3 Mounted on Reciprocating Control Valve

1. Mount the standard reciprocating mounting bracket to the valve with two 5/16" - 18 UNC cap screws and apply wrench tight.

Mounting hole selection for the bracket is defined in Table 2, based on actuator size and stroke.

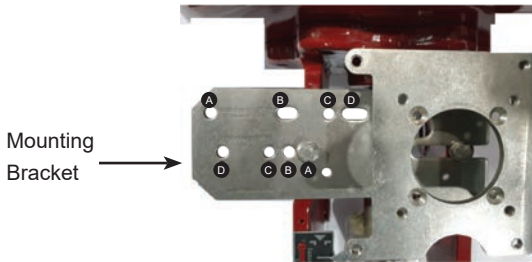

Figure 8 - Reciprocating Valve Mounting Bracket

2. Ensure that the lever is attached to the magnet assembly and held securely by two M5 flat head screws and tightened using 5mm Hex Key.

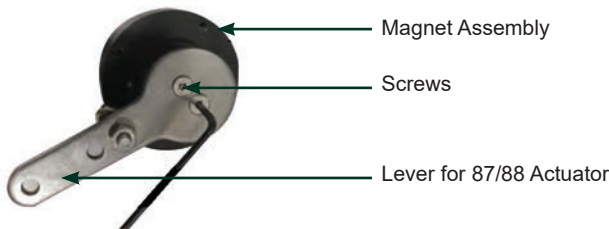

Figure 9 - Magnet Assembly on Reciprocating Valve

3. Select mounting hole A, B, or C for the valve stroke.

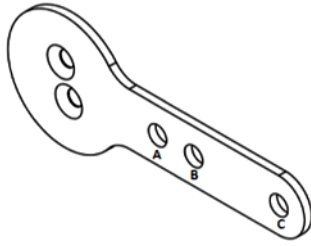

Figure 10 - Lever for Masoneilan Model 87/88 Multi-spring Actuator

Table 2. Valve Linkage Selection Table for 87/88 Type Actuator⁽¹⁾

Actuator Size	Stroke	Mounting Hole	Lever Hole	Turnbuckle Length
6 and 10	0.5 - 0.8" (12.7 - 20.32 mm)	A	A	1.25 " (31.75 mm)
10	>0.8 - 1.5" (30.32 - 38.1 mm)	B	B	
16	0.5 - 0.8" (12.7 - 20.32 mm)	B	A	2.90" (73.66 mm)
16	>0.8 - 1.5" (20.32 - 38.1 mm)	C	B	
16	>1.5 - 2.5" (38.1 - 63.5 mm)	D	C	
23	0.5 - 0.8" (12.7 - 30.32 mm)	B	A	5.25" (133.35 mm)
23	>0.8 - 1.5" (20.32 - 38.1 mm)	C	B	
23	>1.5 - 2.5" (38.1 - 63.5 mm)	D	C	

1. For Masoneilan Model 87/88 actuators only. For other actuators, refer to mounting kit specific instructions.

4. Apply Loctite® on take off rod to split clamp, and on rod end nuts. Thread the take-off rod to the actuator split clamp as shown in Figure 12.
5. Attach the right-hand threaded rod end to the lever using 1/4 - 20 x 1" cap screw and nut, apply wrench tight. Thread the right-hand lock nut and turnbuckle (refer to the table 2 for proper length) onto the right-hand rod end approximately two turns as shown in Figure 12.
6. Thread on the lock nut to rod end and thread the turnbuckle onto the left-hand threaded rod end approximately two turns. Attach the left-hand threaded rod end to the take-off rod with 1/4 - 20 UNC nut and thread the left-hand lock nut onto the rod end as shown in Figure 12.
7. Adjust the turnbuckle vertically to the stem until the hole in the lever is aligned with the hole in the bracket as shown in Figure 11. Tighten both turnbuckle lock nuts and ensure that magnets are in vertical position when properly aligned.
8. Mount the SVI3 to the bracket and secure with four M6 socket head cap screws.



Figure 11 - Alignment Hole

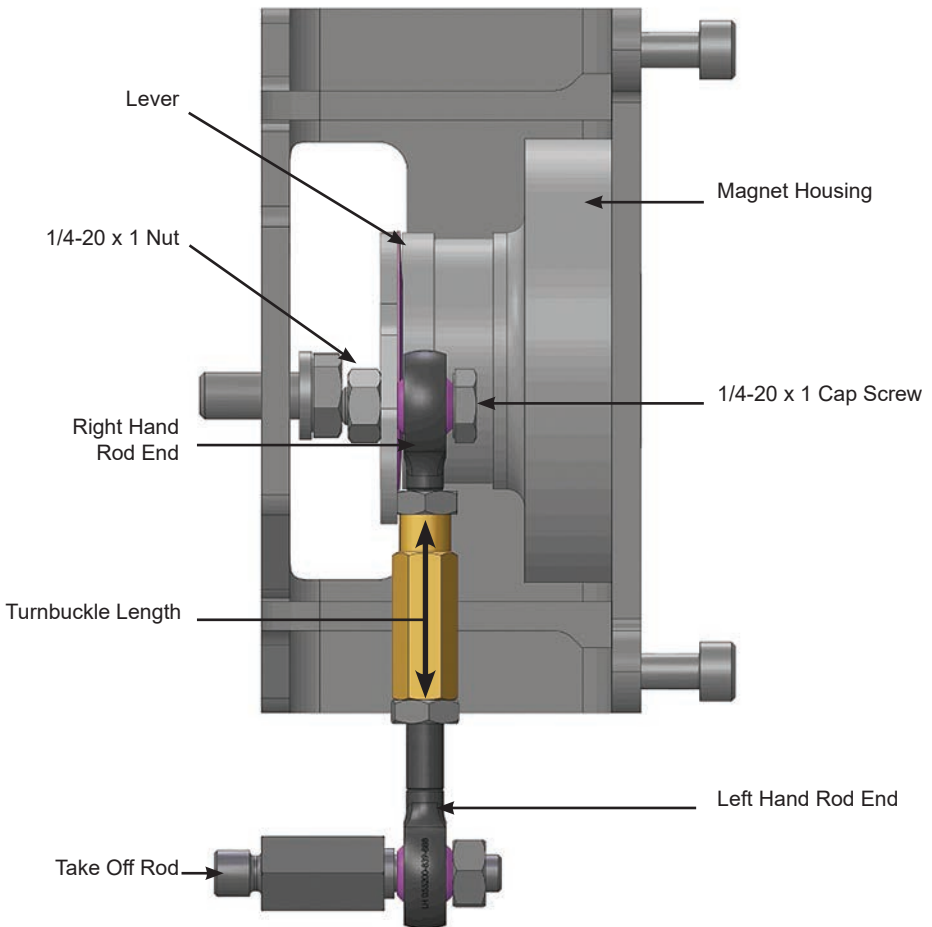

Figure 12 - Reciprocating Linkage

Tubing and Air Supply to SVI3

1. Install the tubing to the SVI3 air supply port through air regulator as shown in Figure 13.
2. Ensure that there is no pinches in the tubing and all the fittings are leak free.
3. Confirm that the air regulator is adjusted to the lowest setting prior to turning on air supply.
4. Turn on the air supply and adjust the air regulator to reach required actuator supply pressure. Maximum air supply pressure should not exceed actuator design pressure or SVI3 pressure limit (max.120 psi).

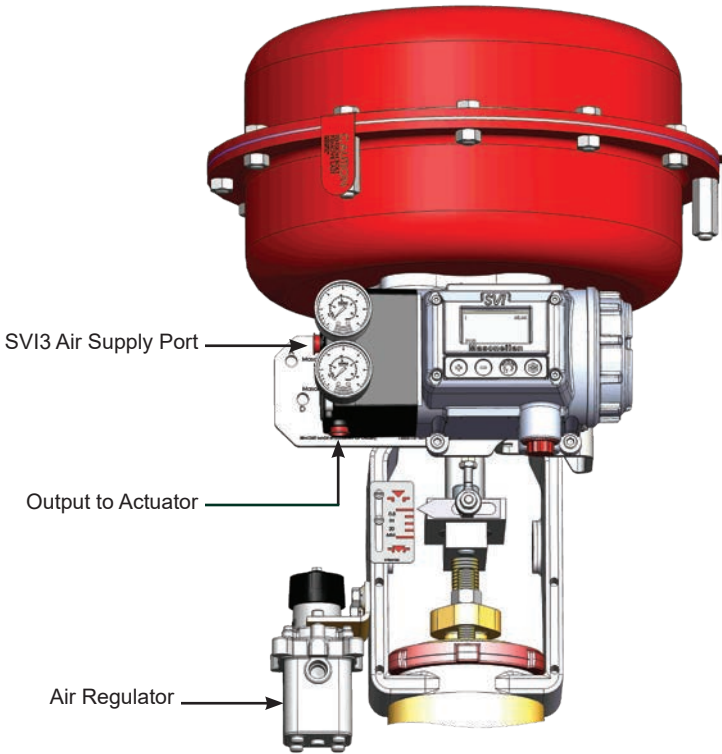

Figure 13 - Air Supply

SVI3 Wiring Procedure

The SVI3 uses a 4-20mA signal with HART communications to control the connected pneumatic actuator. This section describes the SVI3 wiring configuration via ValVue3/SVI3 DTM software and HART I/O modules (for PLC and DCS), or a HART modem/HART handheld communicator.

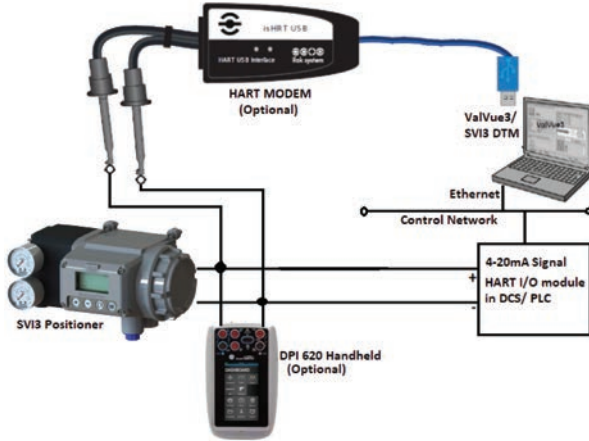
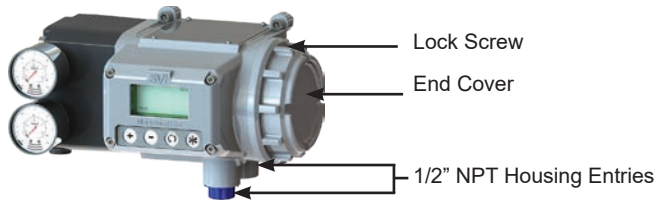

Figure 14 - Wiring Diagram

1. Disengage the lock screw before removing the end cover.
2. Unscrew the end cover and remove the 1/2" NPT plastic cover for cabling. The user can remove additional 1/2" NPT plug if extra ports are needed.

Figure 15 - SVI3 Digital Positioner (front view)



3. To connect the SVI3 to the control loop, use the suitable cable gland as per the end user country regulations.

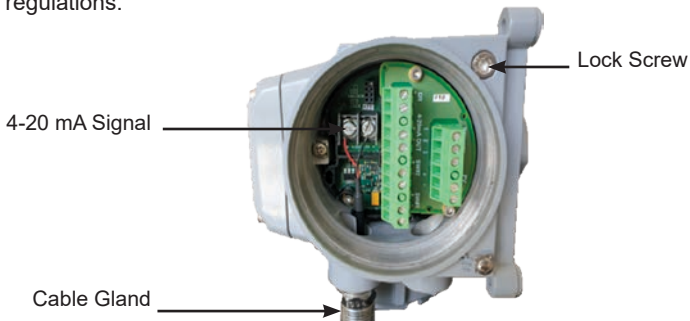

Figure 16 - Connections to Main Electronics Module

4. If an Options Module is installed, refer to Figure 17 for connector pin assignment.

Note: Refer SVI3 IOM for further installation, wiring, configuration of I/O.

- Two solid-state switches (SW #1 and SW #2)
- 4-20 mA output to support position retransmit functions
- Digital Input (DI)
- Remote position sensor input
- Process Variable (PV)

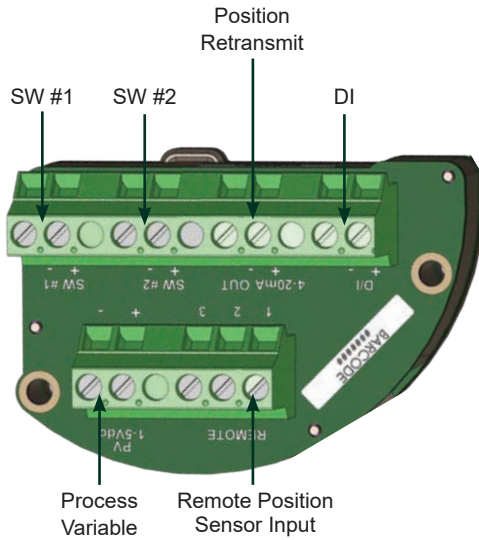

Figure 17 - Optional Modular Connections

5. End cover should be closed and secured with lock screw after wiring, ensure that end cover threads are fully engaged.

Local Commissioning with Pushbuttons and Local Display

The pushbuttons perform the following functions:



Allows the user to go to the next item in the menu or to increase the value currently shown in the digital display. Press and hold this button continuously, the displayed value increases at faster rate.



Allows the user to go to the previous item in the menu or decrease the value currently shown in the digital display. Press and hold this button continuously, the displayed value decreases at faster rate.



Launch the Smart Cal routine by following the process detailed below. This button is intended to be a cancel/back button first, followed by the smart cal trigger.

To execute the SMART CAL sequence, set ATO/ATC in the positioner and follow the on the screen instructions to calibrate stops and tune valve. Refer to Figure 18.

1. Press and hold SMART CAL button



2. Release the button for Calibration



3. Confirmation for Calibration



4. Calibration in progress

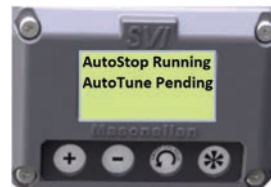

Figure 18 - SVI3 SMART CAL Operations



Allows the user to accept the value or parameter option currently displayed.

The SVI3 pushbutton menu structure helps to perform device operations such as configuration, calibration, viewing data, and viewing errors.

Note: Refer SVI3 IOM for full button menu.

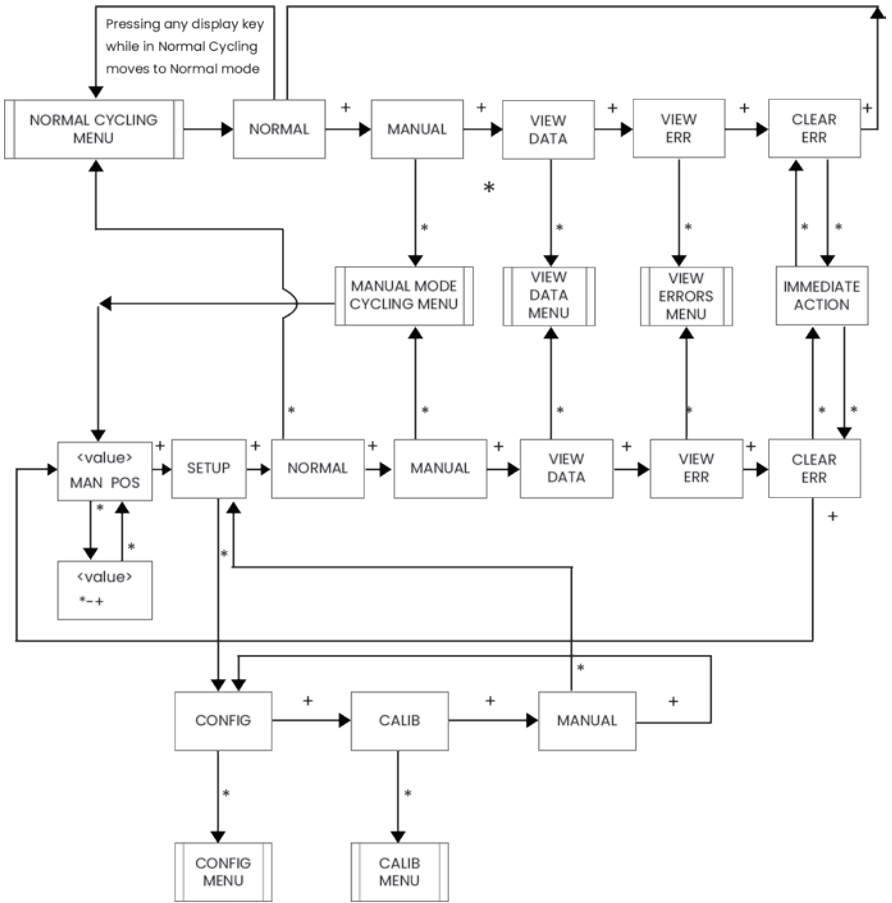

Figure 19 - Pushbutton Menu Structure

Remote Commissioning with DTM Based ValVue™ 3

Note: Refer to the ValVue3/SVI3 DTM Manual for the software installation, HART Modem and device configuration procedures.

1. Upon successful device connection and DTM launch, the Online Parameters are displayed in the DTM screen.

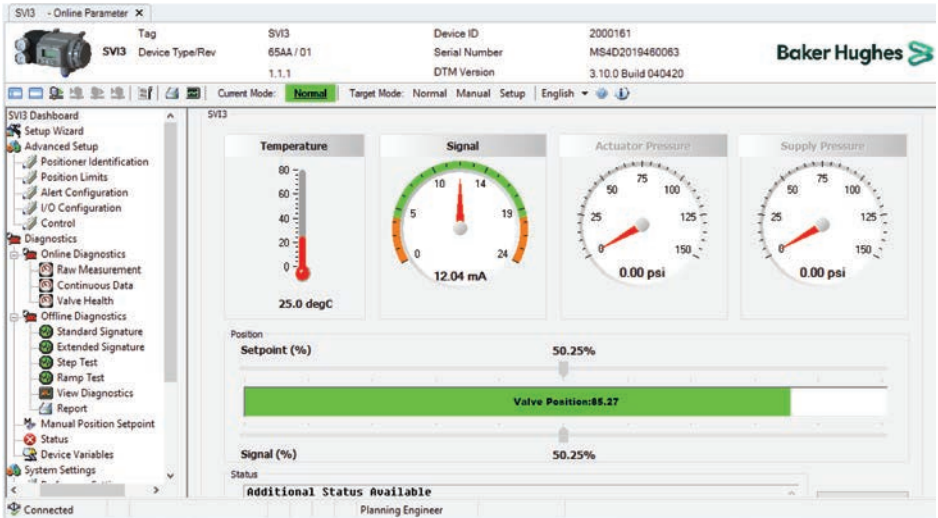

Figure 20 - SVI3 Online Parameters

2. For device configuration, the SVI3 should be in the **Setup** mode. Click **Setup** in the DTM screen to switch the device into Setup mode.

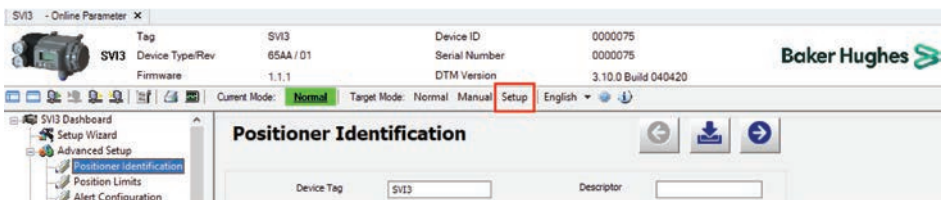

Figure 21 - Change Setup Mode

- Use **Setup Wizard** for basic device configuration. For advanced configuration options refer SVI3 IOM and/or DTM manual for more details.

Click **Setup Wizard** on the left pane. In the Setup Wizard screen, choose the appropriate “Air Action”, and the calibration will be performed automatically.

Put the device back to Normal mode once the configurations are done.

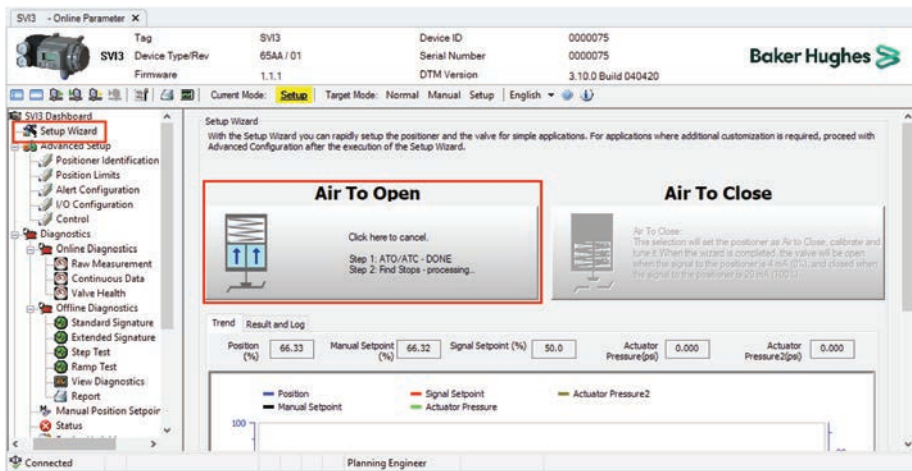

Figure 22 - Setup Wizard

- The **Status** tab displays the device status for any kind of device faults, warnings, and errors.

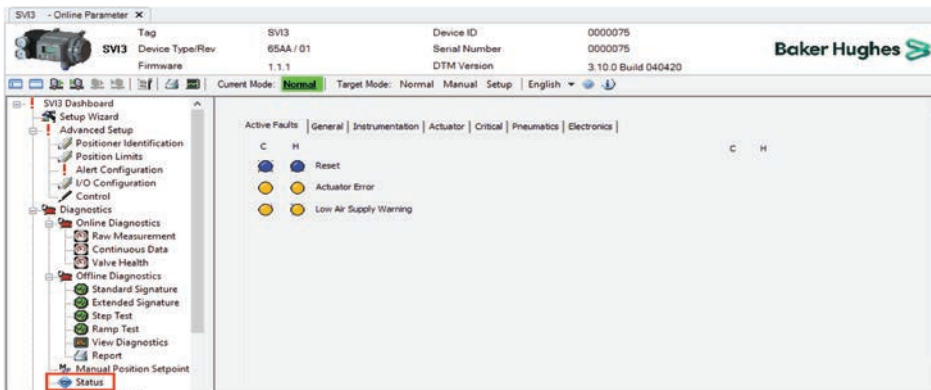

Figure 23 - Device Status

Commissioning with Handheld Communicator

1. Copy or load the SVI3 DD files to the handheld communicator.
2. Connect the handheld communicator as shown in Figure 14, and turn the power ON, the home screen will be displayed as below.

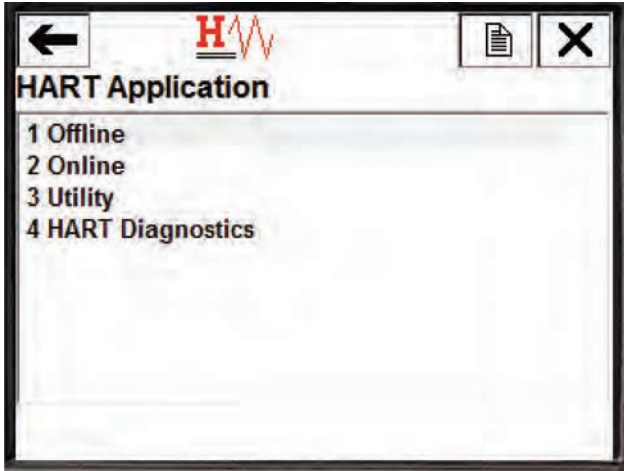

Figure 24 - Handheld Communicator Home Screen

3. Select **Online** menu in the home screen, the SVI 3 online parameters are displayed as shown in Figure 25.

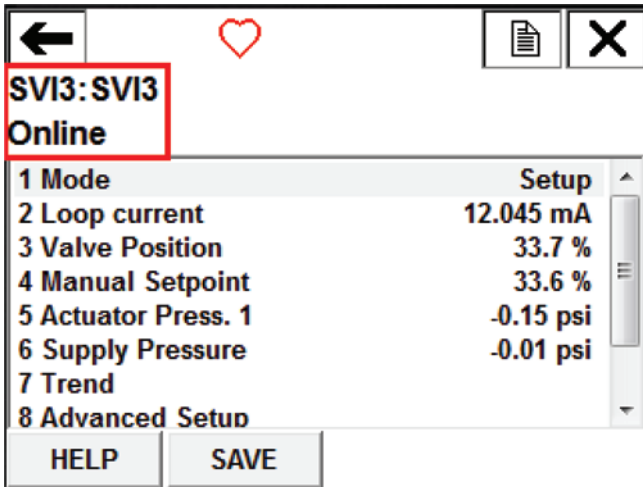

Figure 25 - SVI3 Online Parameters

4. Select **Advanced Setup** menu from Online screen and navigate to the **Setup Wizard** to perform the device operations such as Change Device Mode, Run Find Stops, and Auto Tune.

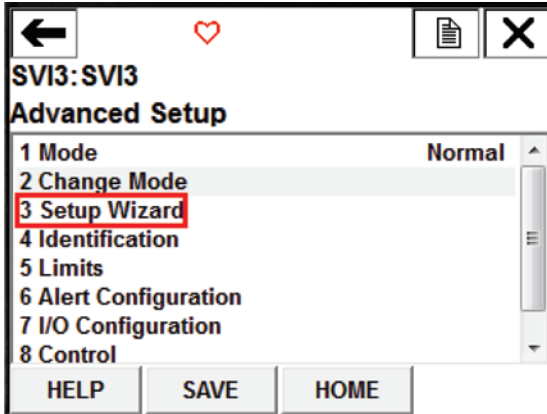

Figure 26 - Advanced Setup Menu

5. For device configuration or to run **Find Stops** and **Auto Tune**, the device should be in the **Setup** mode.

Click **Setup** in the Set Mode Target screen to switch the device to Setup mode.

Put the device back to Normal mode once the configurations are done.



Figure 27 - Set Mode Target

6. Perform **Find Stops** and **Auto Tune** using the following screens for the device setup.

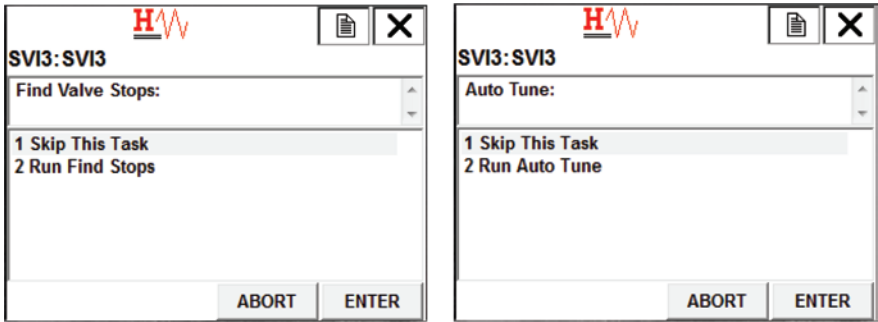

Figure 28 - Run Find Stops and Auto Tune

Direct Sales Office Locations

Australia

Brisbane
Phone: +61-7-3001-4319

Perth
Phone: +61-8-6595-7018

Melbourne
Phone: +61-3-8807-6002

Brazil

Phone: +55-19-2104-6900

China

Phone: +86-10-5738-8888

France

Courbevoie
Phone: +33-1-4904-9000

India

Mumbai
Phone: +91-22-8354790

New Delhi

Phone: +91-11-2-6164175

Italy

Phone: +39-081-7892-111

Japan

Tokyo
Phone: +81-03-6871-9008

Korea

Phone: +82-2-2274-0748

Malaysia

Phone: +60-3-2161-03228

Mexico

Phone: +52-55-3640-5060

Russia

Veliky Novgorod
Phone: +7-8162-55-7898

Moscow

Phone: +7-495-585-1276

Saudi Arabia

Phone: +966-3-341-0278

Singapore

Phone: +65-6861-6100

South Africa

Phone: +27-11-452-1550

South & Central America and the Caribbean

Phone: +55-12-2134-1201

Spain

Phone: +34-935-877-605

United Arab Emirates

Phone: +971-4-8991-777

United Kingdom

Phone: +44-7919-382-156

United States

Houston, Texas
Phone: +1-713-966-3600

Find the nearest local Channel Partner in your area:

valves.bakerhughes.com/contact-us

Tech Field Support & Warranty:

Phone: +1-866-827-5378

valvesupport@bakerhughes.com

valves.bakerhughes.com

Copyright 2021 Baker Hughes Company. All rights reserved. Baker Hughes provides this information on an "as is" basis for general information purposes. Baker Hughes does not make any representation as to the accuracy or completeness of the information and makes no warranties of any kind, specific, implied or oral, to the fullest extent permissible by law, including those of merchantability and fitness for a particular purpose or use. Baker Hughes hereby disclaims any and all liability for any direct, indirect, consequential or special damages, claims for lost profits, or third party claims arising from the use of the information, whether a claim is asserted in contract, tort, or otherwise. Baker Hughes reserves the right to make changes in specifications and features shown herein, or discontinue the product described at any time without notice or obligation. Contact your Baker Hughes representative for the most current information. The Baker Hughes logo, Masonneilan, SVI and Camflex are trademarks of Baker Hughes Company. Other company names and product names used in this document are the registered trademarks or trademarks of their respective owners.

Baker Hughes 