

Advanced inspection services

SMART • INTELLIGENT • ROBOTICS • SOLUTIONS

| Everywhere. Everything. Every Time.

Advanced inspection services

Qualified and fast solutions for your inspection task

With our highly-trained personnel and our broad product portfolio, we are able to respond to your problems and find a custom solution.

Proactive and predictive inspections ensure peak performance of your assets and will support your maintenance concept.

The failure of individual machines costs money and can bring the entire production process to a standstill. The sooner the cause of the malfunction is detected, the sooner the problem can be solved. Our inspection service specialists have industry experience and are specially trained. Every employee has at least the qualification for Visual Testing (VT) level 2, a fundamental technical education and training.

Without time-consuming disassembly, video endoscopy or other NDT techniques enable fast and safe localization of faults—even in dangerous areas that are not directly accessible. Detailed images and measurement, precise and reliable data allow the exact assessment of damage so that you can quickly initiate the right measures for maintenance work. And finally, we will send you a detailed report on our inspection results.

As our service inspection team consist of experienced NDT engineers for VT, UT, as well ET, and we have access to our BHGE Inspection Technologies application labs. We can offer special customized services, e.g. robotic systems equipped with different tools or latest testing systems.

Give us a call.

LISTENING • UNDERSTANDING • DELIVERING

- Unique, integrated mix of Intelligent, sensor-based asset inspection systems
- Permanent asset health monitoring systems
- Enhanced UT and electromagnetic measuring sensors for assessing erosion and corrosion defects in non-accessible and/or hazardous environments
- Wireless technology for inspection data capture from pipes, vessels, tanks; even in hazardous locations
- Data quality; consistent data gathering with high probability of detection (POD)
- Automated data capture using machine-human interaction, avoiding confined space entry, working at heights, dangerous environments
- Data visualization; analysis software, 3D modeling, advanced machine learning
- Protecting health, safety and the environment



AGING ASSETS • LIFE EXTENSION • PREDICTING OUTCOMES

Oil & Gas



Refinery



Chemical Industrial



Environment, Infrastructure



Piping



Processing

Power



Renewable



Power



Turbomachinery



Biomass



Water, Hydro & Process Tech.



Nuclear



Coal

Transportation



Transportation



Aviation



Automotive



Marine Transportation

Other



Food & Beverage



Pharmaceutical

Our vision

COLLABORATIVE • COMPETENT • COMMITTED

- Be the key provider of advanced robotics inspection technology as a service
- Accurately detect, measure, and visualize the true condition of aging and defective assets
- Support digital asset integrity management and remote monitoring solutions to extend useful life of ageing assets
- Train, develop, and retain skilled inspection personnel to achieve the highest levels of competence, provide high-quality engineering support within the industry
- Seek out innovative solutions for difficult to solve problems
- Extend our experience and solutions knowledge across all industries
- Research, develop, and deploy new technology as new customers become aware of our solutions, technology, and capabilities
- Further introduce key hardware technology (connectivity) to provide opportunities for new business models
- Adherence and compliance with HSE regulations and requirements

Inspection programs are evolving. The digital age has arrived. Imagine the unimaginable.

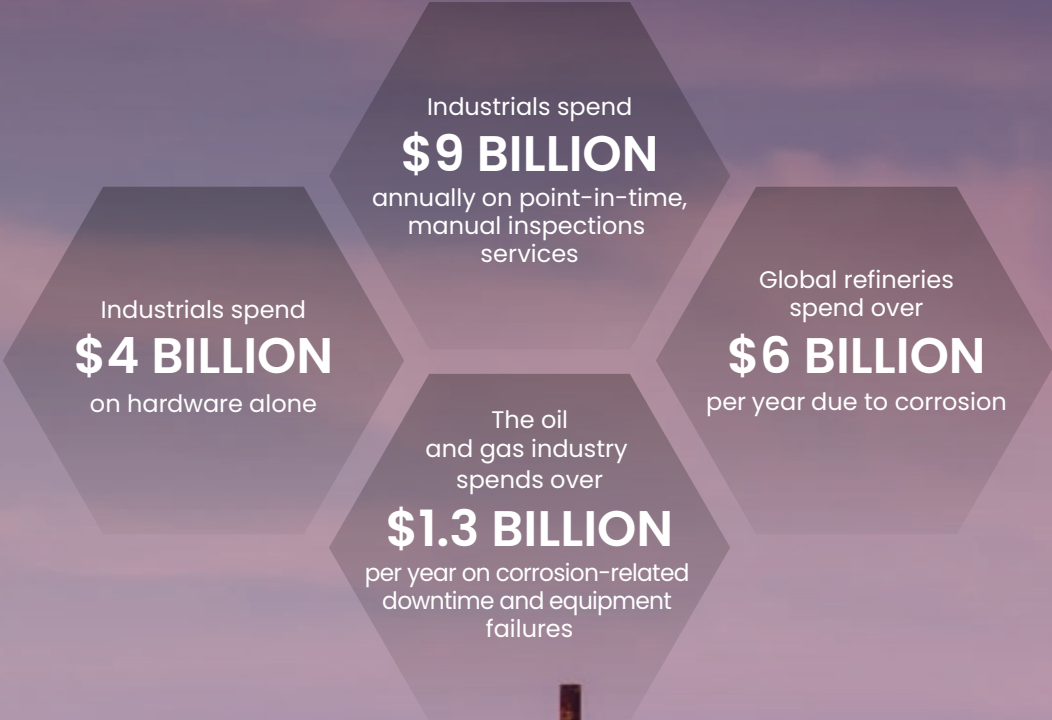

SMART • INTELLIGENT • ROBOTICS • SOLUTIONS

Our services product portfolio

REMOTE VISUAL INSPECTION • FASTER • SMARTER • SAFER

We offer a large product portfolio in order to be able to offer the best possible service and to be able to identify a solution for each unique problem, as shown further in this brochure.

In order to operate effectively, we do not only have our own products in stock, but also stock products from other manufacturers — the selection is based on providing an optimal, cost-effective solution.

A large, varied selection of tools and sensors enables us to respond to your requirements as quickly as possible.



Mentor Visual iQ – VideoProbe*

The first 3D measurement-enabled HD video borescope

For critical equipment inspections, Mentor Visual iQ with 3D Phase Measurement provides precision and productivity. The 3D Phase Measurement combined with the Mentor Visual iQ can create a 3D surface scan of the viewing area and can measure all aspects of surface indications using a 3D scan.

3D measurement technologies

Advanced video borescopes allow inspectors to map, measure, and analyze indications with a 3D point cloud and to share images and data wirelessly with remote experts. Measure with captured image and 3D point cloud side-by-side.

3D phase measurement – A patented technology that uses projected line patterns and phase-shift analysis to compute a 3D point cloud. Eliminates tip changes by providing a high-quality, full-screen image for general inspection with measurement on demand. Available on 6.1 mm diameter probes.

3D stereo measurement – Combines a patented stereoscopic optical design with proprietary processing algorithms to compute a 3D point cloud. View video image and measurement side-by-side. Available on 4 mm, 6.1 mm or 8.4 mm diameter probes.



Customer service:

- Gas turbines
- Wind turbine gearboxes
- Steam turbines
- Generators
- Rotating equipment
- Piping systems
- Aircraft engines
- Locomotives
- Heat exchangers



Pan-tilt zoom cameras

Compact, robust, and portable

The rugged and robust pan-tilt-zoom cameras place image management in the palm of your hand, combining interchangeable camera heads, advanced software, integrated image capture, and full motion video recording in a compact unit that can be used in air or underwater for efficiency and ease. With remote viewing capabilities, you can inspect for cleanliness, defects, interior indications of cracks, and many other features of vessel surfaces. The collection of digital images allows for historical comparisons to identify and track changes of tanks or vessel profiles.

Intuitive

- Integrated temperature warning system
- USB streaming
- No exposed wiring
- Handheld controller with built-in VGA LCD monitor for remote operation
- On-screen magnification, pressure, PTZ position, and time/date display
- USB stick for additional storage

Effective

- Integrated image capture
- Advanced image management
- High-performance variable dual-lighting control
- Camera Control Unit with internal memory and removable storage
- Integrated super bright light source

Customer service:

- | | |
|-----------------------|---------------------------|
| • Storage tanks | • Reactors |
| • Flares | • Furnaces |
| • Crude units | • Blowout preventers |
| • Catalytic crackers | • Chimneys |
| • Catalytic reformers | • Elevator shafts |
| • Tower trays | • Hydrostatic sterilizers |



PTZ 6.2 cameras

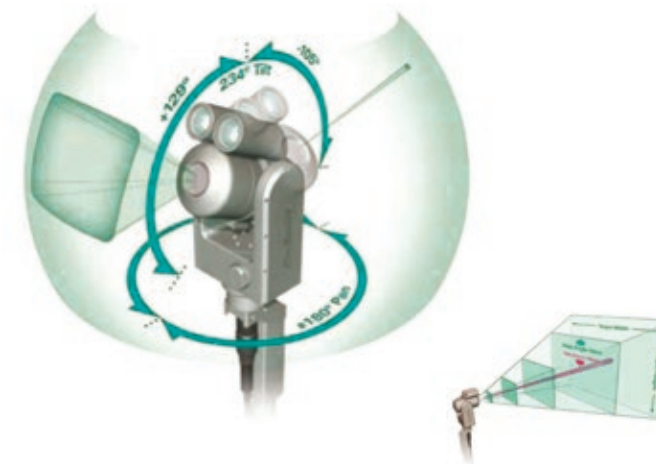

PTZ140

- Incorporates a 40x optical with a 12x digital for a 432x total zoom capability. Additionally, the camera is equipped with high-powered 35 watt lights offered with wide and narrow beam spreads.
- Weight: 3.0 kg (6.7 lb) – aluminum
- Size: 287.0 mm (12.60") L x 139.7 mm (5.49") Ø fits through a 140 mm (5.5 in) Ø opening

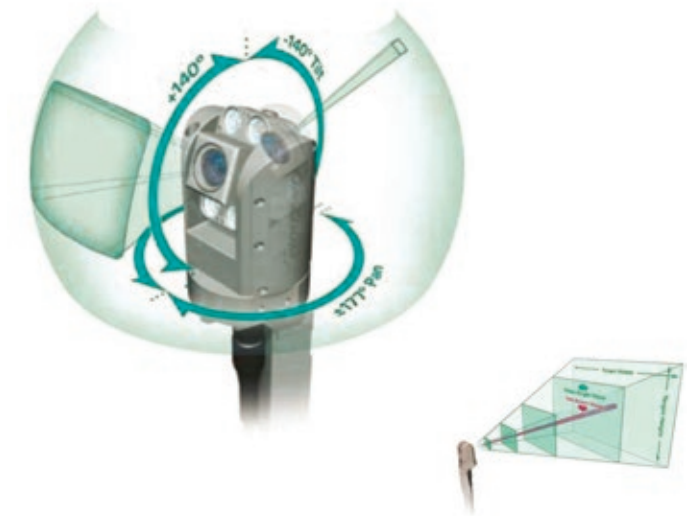

PTZ100

- Incorporates a 10x optical with a 4x digital for a 40x total zoom capability. Additionally, the camera is equipped with four 5 watt LED lights offered with wide and narrow beam spreads.
- Weight: 3.0 kg (3.9 lb) – aluminum
- Size: 194.0 mm (7.65") L x 98.4 mm (3.88") Ø Fits through a 100 mm (3.94 in) Ø opening

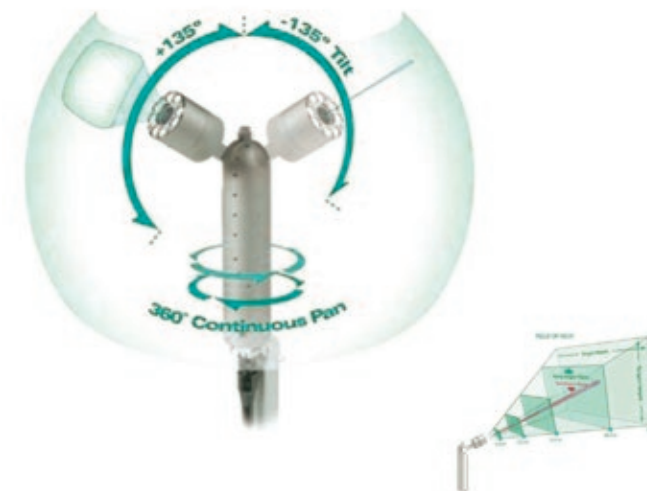

PTZ70

- Incorporates a 10x optical with a 4x digital for a 40x total zoom capability. Additionally, the camera is equipped with four 5 watt LED lights offered with wide and narrow beam spreads.
- Weight: 2.5 kg (5.5 lb) – aluminum
- Size: 194.0 mm (18.4") L x 69.8 mm (2.75") Ø Fits through a 76 mm (3.00 in) Ø opening

Crawler systems

The camera crawler vehicles for pipeline inspections from DN100 to DN1600 are robust and steerable.

It comes with an electronic stabilizing function, which brings the crawler back to the invert of the pipeline if there is a horizontal displacement.

Accessories

- Compatible with different PTZ cameras in different sizes and specifications
- Wheelsets, tractor tires, additional weights, and egg profile add-on

Customer service:

- Nuclear head reactors
- Cooling towers
- Process lines
- Wind turbine blades
- Underground pipes
- Fin fans
- Valves
- Water injection systems
- Dams



Push camera systems

Push camera systems are one of the fastest and easiest ways for visual inspections. With a push camera, inspections of pipelines and containers can be carried out in the shortest possible time, and unnecessary disassembly is no longer necessary. Different camera heads are used for different applications.

A small opening is sufficient to obtain large and wide views of components or pipelines. By using a wide variety of push camera systems, it is possible to achieve the best results.

For example, weld seams can be inspected 360 degrees with a pan-tilt camera head and examined for a wide variety of defects. It is possible to inspect pipes with different diameters and lengths (up to 60m) for dirt, blockages, or damage.

Customer service:

- Boiler tubes
- Furnaces
- Electrical conduits
- Headers
- Heat exchangers



ATEX

Flammable and explosive substances in form of gases, vapors, mists or dusts occur in many areas of the chemical and petrochemical industries. If ignited, there is a risk of serious personal injury and damage to property. The equipment used in these areas must not cause any ignition sources. Compliance with the worldwide standardized types of ignition protection ensures that no ignition sources can occur, either during normal operation or in the event of internal device faults.

Until DN50

The Pearpoint P374 IS Push Rod Camera is suitable for pipe sizes from 25 mm and is capable of inspecting pipelines up to 60 m via the reinforced cable.

- Inspection range
- ATEX rating: Zone 0
- Pipe size: from DN25 and up
- Cable length: up to 80 m (3150")

DN50 to DN150

The BAK MiniLite is the compact Explosion Proof (ATEX) Push rod Camera System for inspecting pipelines and smaller containers from DN80 and up.

- Inspection range
- ATEX rating: Zone 1
- Pipe size: from DN80 and up
- Cable length: up to 80 m (3150")

From DN150 up to 30m

The IBAK T 76 is a robust and steerable camera tractor for inspecting pipelines and confined spaces from DN 150. The integrated sensors for pressure monitoring and optional explosion protection reliably ensure the safety of the devices and the location of the system.

- Inspection range:
- ATEX rating: Zone 1
- Pipe size: from DN150 and up
- Cable length: up to 200 m (7874")
- Zoom : 10x optical zoom



Customer service:

- Process lines
- Waste lines
- Sewer systems
- Railroad tank cars

Foreign material exclusion (FME)

Lost it? Time is money

It can happen to you. We know even the smallest objects can cause large expenses for your facility. Our Foreign Object Search And Retrieval (FOSAR) services will locate and remove foreign material from your system.

We have a greater than 98% retrieval success rate, a staff of trained and experienced technicians, and the widest range of retrieval tools in the industry.

Our FME program is available for following inspection applications: Vast capabilities with standard and customized retrieval tools, robotic video crawlers, magnetic retrieval, mechanical retrieval, vacuum retrieval, closeout inspections, startup commissioning.

- 1 Loose part in tank 
- 2 Retrieval claw approaching loose part 
- 3 Retrieval claw grasping loose part 
- 4 Loose part retrieved 



Video borescope

- Diameter: 4.0 mm – 8.4 mm
- Length: 3 m – 30 m



Push camera

- Diameter: 110 mm – 1350 mm
- Length: 1 m – 500 m



Robotic crawler

- Diameter: 25 mm – 70 mm
- Length: 1 m – 70 m

Customer service:

- Gas turbines
- Steam turbines
- Generators
- Boilers
- Aircraft engines
- Vessels



FAST RVI

The FAST RVI is deployed through an accessible entryway, typically the manhole. Several configurations can be covered by different deployment methods. The operator is controlling the system from a safe remote location.

The advanced kinematics of the platform has several degrees of freedom. This allows it to freely navigate inside tanks and vessels on curved or double curved surfaces. An overview camera assists the operator in maneuvering the robot to the location of interest. Once the platform has arrived, the inspection camera is used to collect the required footages per inspection plan. Using the extreme high zoom capabilities (up to 36x optical zoom) most data will be collected from the opposite wall, which allows a very clear view on the features to inspect.

At any point in time, the operator stays out of the dirty and dangerous confined space area.

Customer service:

- Storage tanks
- Turbine inlets
- Vessels

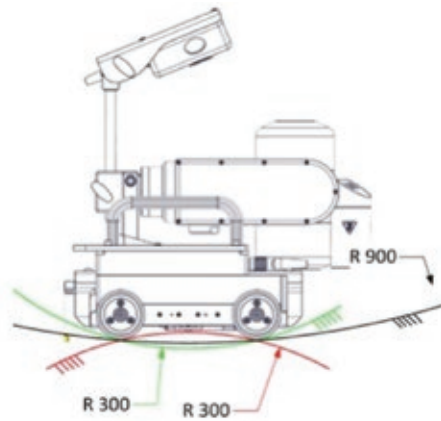

For in-vessel inspection a minimum vessel radius of 300 mm (11.8") is mandatory. This allows for axial driving. Full maneuverability, incl. spot turn is possible at a radius of 900 mm (35.4").

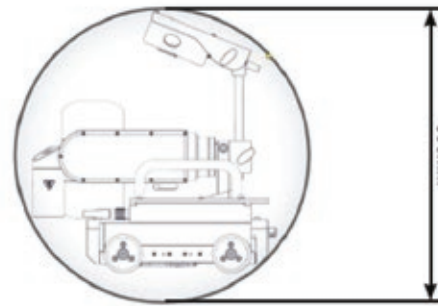

Minimum size of entryway for safe deployment and retrieval of the inspection system is 500 mm (20").



BIKE platform

Ultra mobile inspection robot

One of the main advantages of mobile robots is their ability to reach locations inaccessible by human because of size constraints, temperature, immersion in liquids, or safety reasons. Certified and experienced engineers today enter confined spaces and "look" at the predefined locations to take pictures for reporting.

This is the state-of-the-art procedure. Beside very expensive organizational issues, such as watchmen and ventilation, this procedure is very dangerous for the experts. New robotic and sensor technology can provide solutions to reduce costs and risk of such procedures.

Customer service:

- Refineries
- Oil rigs
- Pipelines
- Ship hulls
- Steel bridges

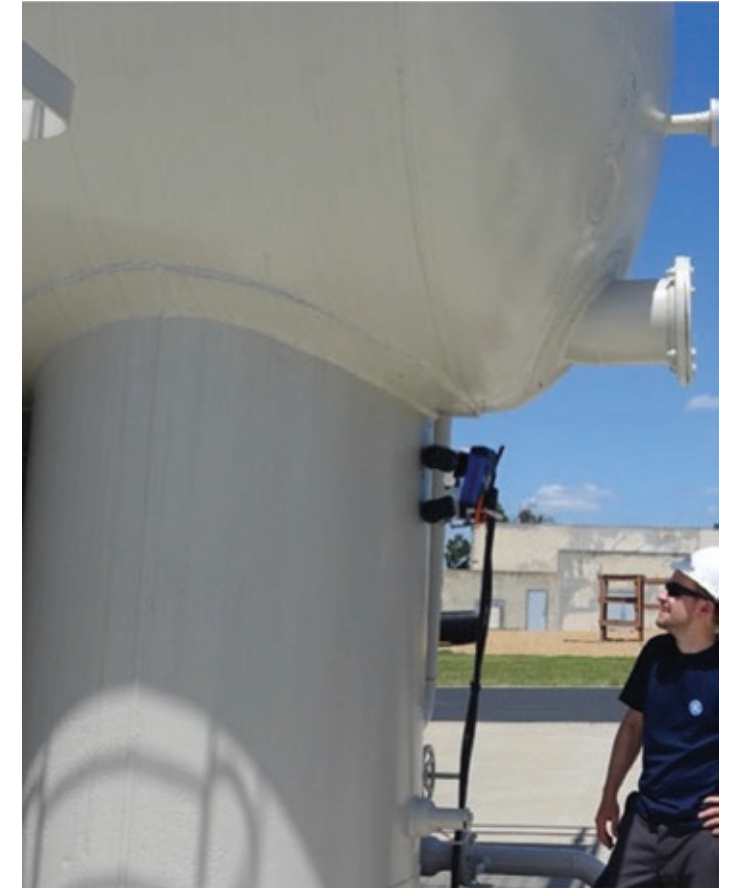

In this framework, the BIKE inspection robot has been developed. The BIKE platform is a magnetic wheeled robot capable of inspecting power plant facilities and multiple applications in the oil & gas industry, such as vessel or pipe inspection. The innovative locomotion concept allows climbing obstacles such as stairs and 90 degree corners (convex & concave).

With integrated navigation cameras and 3-dimensional position sensors, the operator gets precise information about the robot's position, even in complex environments. Multiple additional modules, such as ultrasonic probes or borescope holders, are available to extend the function of the robot and open new ways for inspection without human entry in confined space.

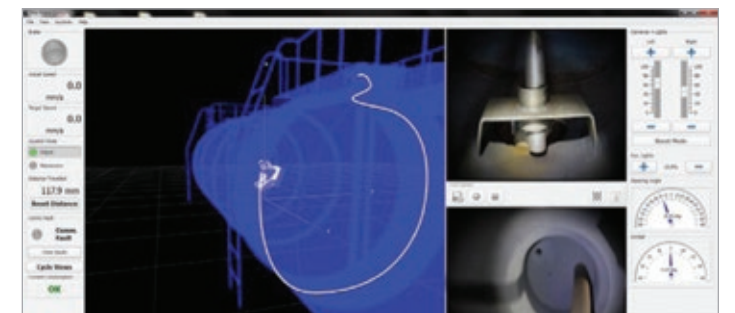

Flyability ELIOS drone

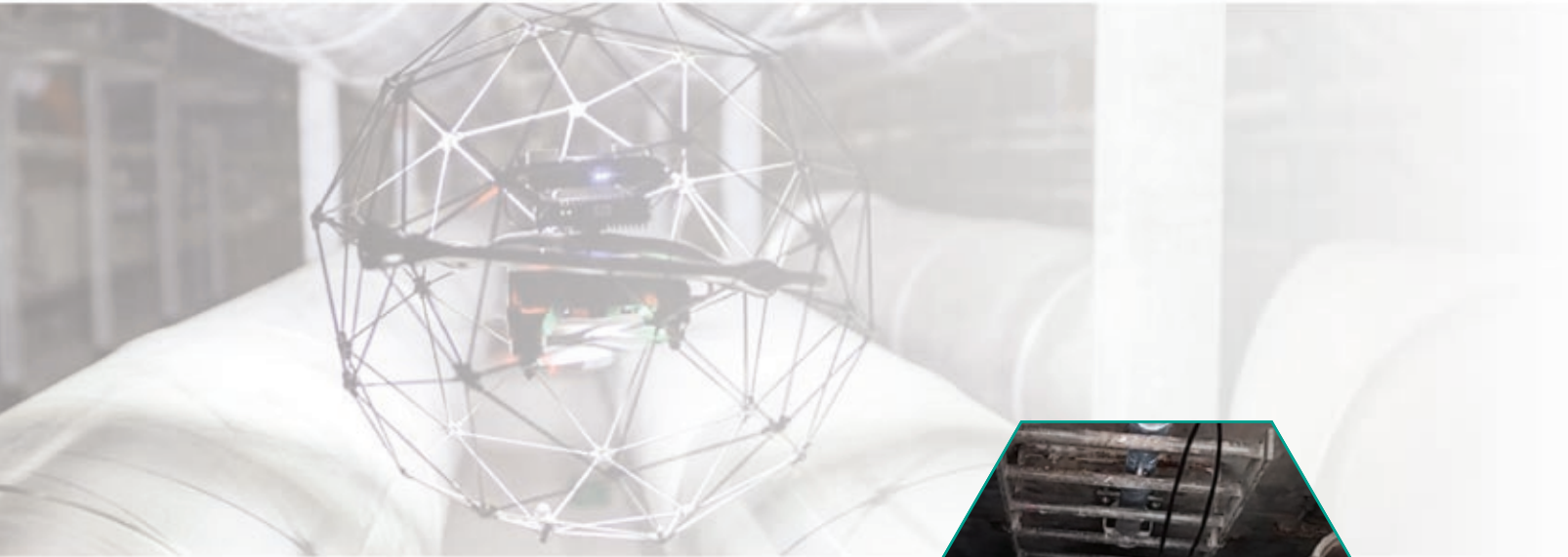

Drone technology is steadily being incorporated as a sustainable practice for asset managers in the energy industries. Nonetheless, current solutions are unable to operate close to structures or in contact with operators, restricting effective inspection in complex environments.

While conventional methods are still required for maintenance, preliminary inspection can be performed at lower cost, risk, and infrastructure downtime. Flyability aims at becoming the leading technology provider in exploration and inspection of confined spaces and complex environments.

Customer service:

- Boilers
- Furnaces
- Vessels
- Storage tanks
- Cooling towers
- Large headers
- Grain silos



Pipeline robot systems

This systems are modularly designed and can be retrofitted quickly and without any special tools for the specified tests and inspections. This new system embodies and reflects 30 years of practical experience in the fields of designing, developing, and manufacturing video-endoscopic systems and testing them in close cooperation with our customers.

Benefits

- Multi-functional use and easy handling
- Modularly designed controls
- Due to the modular design, customized and user-specific modifications can be carried out quickly and in a cost-effective way.
- Light-intensive illumination system with powerful white-light LEDs (8000 K color temperature)
- Pan-tilt camera-modules
- Exchangeable camera heads with integrated lighting rings
- Manual or remotely-controlled focusing
- Negotiation of the smallest pipe bends of ID by the system without any problems
- Minor obstacles, uneven surfaces, and changes in the cross section will be automatically adjusted.

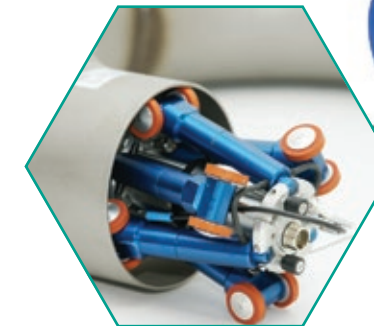

Corrosion under pipe support (CUPS)

Corrosion under pipe supports is one of the most important causes of topside piping failure. Aboveground piping typically lies on supports of different geometries but with similar effects regarding the need for inspections on a regular basis of the pipe-to-support interface for corrosion.

Pipe supports are areas of high risk due to deterioration mechanism:

- Crevice corrosion
- General corrosion
- Wear/fretting
- Stress corrosion cracking

Reasons are:

- Constructional or production-related crevice
- Moisture retention
- Coating failure
- Corrosion loss of containment

Visual inspection is a common method to detect CUPS, but pipe support corrosion is a hidden threat. The correlation between visible corrosion and actual corrosion is unreliable and difficult. Access to the location of interest is often not possible, thus it is not always feasible to perform a visual inspection. Pipe lifting, or removal of the support and temporary support of the pipeline, will be necessary to get access to these locations. Both methods will be costintensive, time consuming, and increase the risk of loss of containment.

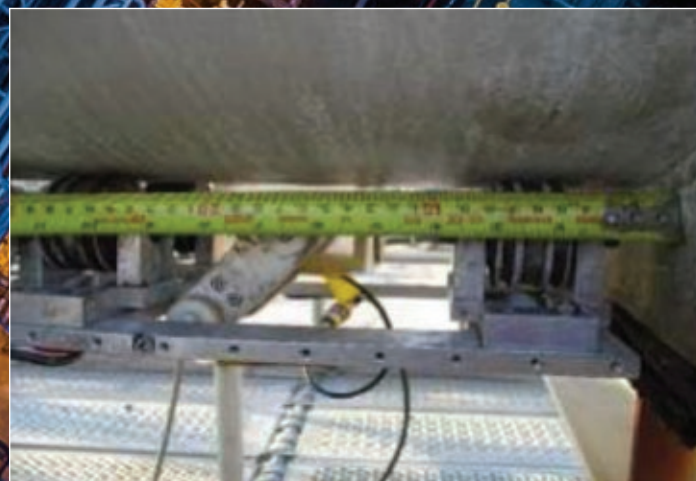

Corrosion under pipe support detection and sizing of corrosion damages

HOMC technology

- A reliable onstream inspection tool using HOMC guided waves technology
- It is an automated scan system for reliably detecting and sizing of corrosion under pipe supports, including pitting.
- Entire equipment is USB powered, built with field ruggedness in mind—tested and validated
- Basic calibration routine and sizing algorithms are in place, and performance has been great for most pipe support defects using HOMC.
- Reliable and precise data
- Basic for further assessment work
- Available for the most common pipe diameters
- Very fast and easy inspection

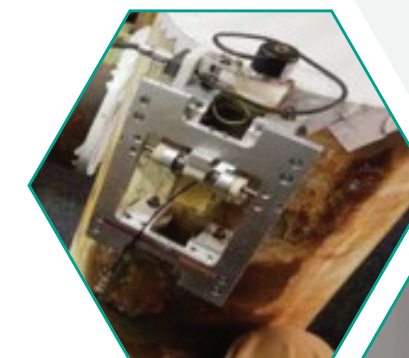

Tank onstream annular plate scanning (TAPS)

Tank annular plate scanning (TAPS) is a new concept for the improved inspection of corrosion under the annular plate region in large storage tanks using a medium-range ultrasonic guided wave technique that uses a collection of higher order modes clusters, called HOMC.

This technique employs the piezoelectric mode of generation of ultrasonic guided waves modes with appropriate wedges. Ultrasonic guided waves (axial mode waves, in this case) once generated will be reflected from corrosion and other features on the annular plate. Inspection can be carried out from the outside of the tank, even when the tank is in service.

Key benefits

- Very small dead zone – mostly within the probe length (delay) or limited to outside the tank shell
- Sensitive to sharp and restricted corrosion, cracking, and pitting
- Is a screening tool with reasonable sizing ability in bands of <20%, 21-40%, 41-60% and > 60% of wall thickness reduction
- Effective reliable inspection distance within the tank: 6-12 inches
- Mechanized and automated scanning is fundamental for generating HOMC data
- Odometer enables correct positioning of findings, making shape/size estimation reliable
- Reliable and precise data, basis for further assessments
- Detection and sizing corrosion damages underneath the shell

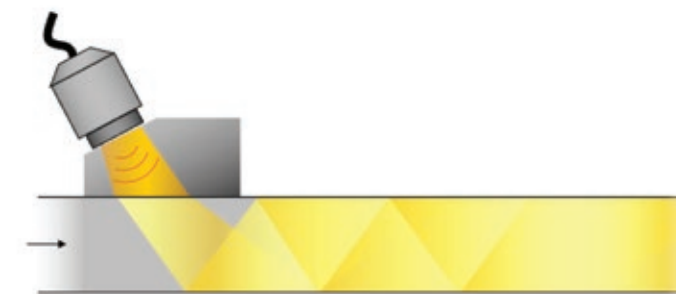

Guided wave

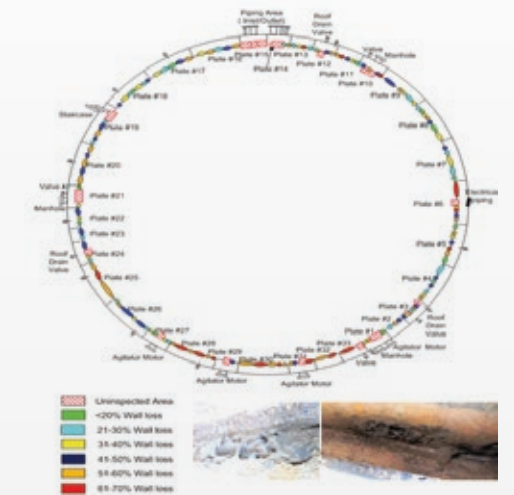

What is the critical zone?

- API 653 defines critical zone as the portion of the tank bottom or annular plate within 75 mm of the inside edge of the shell, measured radially inward.
- The shell-to-bottom weld is one of the highest stressed parts of the tank.

| Smart • Efficient • **Safe!**

Our team is always looking for the right inspection solution adapted to your requirements.

Get in touch with us, and let's improve together.