

# Masoneilan<sup>\*</sup>

## SVI<sup>\*</sup> II ESD

Smart Valve Interface with SIL3  
Emergency Shutdown PST Controller

Installation and Maintenance Manual (Rev. K)



## About this Guide

This instruction manual covers the following instruments and approved software:

Through SVI II ESD -6

- with Firmware version 3.1.2 or greater
- with ValVue\* ESD version 1.0 or greater
- with Handheld HART<sup>®</sup> Communicator with DD published for SVI II ESD
- Masoneilan\* Device Type 203 or 0xCB
- with PRM PLUG-IN ValVue ESD version 1.0 or greater

The information contained in this manual, in whole or part, shall not be transcribed or copied without BHGE's written permission.

In no case does this manual guarantee the merchantability of the positioner or the software or its adaptability to a specific client needs.

Please report any errors or questions about the information in this manual to your local supplier or visit [www.bhge.com](http://www.bhge.com).

U. S. Patent No. 6,957,127, Additional Patents Pending

## DISCLAIMER

**THESE INSTRUCTIONS PROVIDE THE CUSTOMER/OPERATOR WITH IMPORTANT PROJECT-SPECIFIC REFERENCE INFORMATION IN ADDITION TO THE CUSTOMER/OPERATOR'S NORMAL OPERATION AND MAINTENANCE PROCEDURES. SINCE OPERATION AND MAINTENANCE PHILOSOPHIES VARY, BHGE (BAKER HUGHES, A GE company LL AND ITS SUBSIDIARIES AND AFFILIATES) DOES NOT ATTEMPT TO DICTATE SPECIFIC PROCEDURES, BUT TO PROVIDE BASIC LIMITATIONS AND REQUIREMENTS CREATED BY THE TYPE OF EQUIPMENT PROVIDED.**

**THESE INSTRUCTIONS ASSUME THAT OPERATORS ALREADY HAVE A GENERAL UNDERSTANDING OF THE REQUIREMENTS FOR SAFE OPERATION OF MECHANICAL AND ELECTRICAL EQUIPMENT IN POTENTIALLY HAZARDOUS ENVIRONMENTS. THEREFORE, THESE INSTRUCTIONS SHOULD BE INTERPRETED AND APPLIED IN CONJUNCTION WITH THE SAFETY RULES AND REGULATIONS APPLICABLE AT THE SITE AND THE PARTICULAR REQUIREMENTS FOR OPERATION OF OTHER EQUIPMENT AT THE SITE.**

**THESE INSTRUCTIONS DO NOT PURPORT TO COVER ALL DETAILS OR VARIATIONS IN EQUIPMENT NOR TO PROVIDE FOR EVERY POSSIBLE CONTINGENCY TO BE MET IN CONNECTION WITH INSTALLATION, OPERATION OR MAINTENANCE. SHOULD FURTHER INFORMATION BE DESIRED OR SHOULD PARTICULAR PROBLEMS ARISE WHICH ARE NOT COVERED SUFFICIENTLY FOR THE CUSTOMER/OPERATOR'S PURPOSES THE MATTER SHOULD BE REFERRED TO BHGE.**

**THE RIGHTS, OBLIGATIONS AND LIABILITIES OF BHGE AND THE CUSTOMER/OPERATOR ARE STRICTLY LIMITED TO THOSE EXPRESSLY PROVIDED IN THE CONTRACT RELATING TO THE SUPPLY OF THE EQUIPMENT. NO ADDITIONAL REPRESENTATIONS OR WARRANTIES BY BHGE REGARDING THE EQUIPMENT OR ITS USE ARE GIVEN OR IMPLIED BY THE ISSUE OF THESE INSTRUCTIONS.**

**THESE INSTRUCTIONS ARE FURNISHED TO THE CUSTOMER/OPERATOR SOLELY TO ASSIST IN THE INSTALLATION, TESTING, OPERATION, AND/OR MAINTENANCE OF THE EQUIPMENT DESCRIBED. THIS DOCUMENT SHALL NOT BE REPRODUCED IN WHOLE OR IN PART TO ANY THIRD PARTY WITHOUT THE WRITTEN APPROVAL OF BHGE.**

## Copyright

All information contained herein is believed to be accurate at the time of publication and is subject to change without notice.

Copyright 2018 by Baker Hughes, a GE company LLC. All rights reserved.

PN 011523-561 Rev. K.

## Document Changes

Version/Date	Changes
B/04-2011	Removed non-installation software-related issues (See help). Rearranged book. Updated installation. Amended Switches description. Registration section updated to GE logo software.
C/03-2013	Removed references to double-acting.
D/09-2013	Changed the Simplified Switch diagram in Output Switches section and added a cross reference to it in the install section. Added Cautions about Position Low and Upper Limits. Added text about the 4-20 retransmit galvanic isolation.
E/02-2014	Updated load description for optional switches.
F/04-2016	Updated the Installation section and the Fault Matrix. Modified connection drawings for intrinsically safe in Appendices B and C. Made changes to Wiring Guidelines for Position retransmit.
G/08-2017	Added How Do I section. Added Determining Compliance Voltage section. Added Troubleshooting Autotune section. Added Notes on Aggressiveness section. Added DD Navigation section. Modified Burst Mode section.
H/12-2017	Modified DO Switches section.
J/01-2018	Modified DO Switches section.
K/08-2018	Corrected housing construction materials. Added customer contacts. Corrected Factory_Mode alert text. Added Return Authorization.

*This page intentionally left blank.*

# Contents

1. Safety Information .....	17
Introduction .....	17
Terms and Abbreviations.....	17
Acronyms.....	18
Safety Symbols.....	19
Related Literature .....	19
Reference Standards.....	20
SVI II ESD Device Description .....	20
Designing an SIF Using an SVI II ESD .....	21
Safety Function .....	21
Environmental Limits.....	21
Design Verification .....	22
SIL Capability.....	22
Connecting the SVI II ESD to the SIS Logic Solver .....	23
General Requirements.....	24
Installation.....	25
SVI II ESD Installation Configurations .....	25
Physical Location and Placement Guidelines.....	25
Pneumatic Connections.....	25
Electrical Connections .....	25
Operation, Setup, Commissioning.....	25
Maintenance.....	25
Diagnostics.....	25
PST.....	25
SVI II ESD Product Safety .....	27
2. Introduction .....	29
ValVue ESD Overview .....	29
ValVue ESD Software.....	30
ValVue ESD Trial Version.....	30
System Requirements.....	31
Available Models.....	32
About This Manual.....	32

3. Software Installation and Setup .....	33
Install ValVue ESD and PRM Plug-In.....	33
Installing ValVue ESD Software.....	33
Installing the Yokogawa® PRM Plug-In .....	37
Registering ValVue ESD.....	49
Entering Software Keys .....	53
How Do I? .....	55
4. Installation and Setup .....	57
Overview .....	57
SVI II ESD Dimensions and Weights.....	58
Pre-Installation Issues .....	59
Storage.....	59
Unpacking.....	59
Installation .....	59
Physical Location and Placement Guidelines .....	60
Mounting the SVI II ESD on Rotary Valves.....	63
Travel Sensor Alignment.....	65
Mounting the SVI II ESD with NAMUR Kits.....	66
Mounting the SVI II ESD on Reciprocating Valves .....	68
Checking the Magnet .....	71
Using ValVue ESD to Check Magnet Position .....	71
Checking Actuator, Linkages, or Rotary Adapter .....	72
Connecting the Tubing and Air Supply.....	73
Checking the Air Supply.....	75
Wiring the SVI II ESD.....	75
Powering Up the SVI II ESD .....	80
Making Connections to the Terminal Board .....	85
SVI II ESD Maintenance .....	86
Repair and Replacement .....	86
Factory Notification.....	86
Display Cover Removal and Installation.....	87
5. Configuration and Calibration .....	89
Overview.....	89
SVI II ESD Setup.....	89
Configuration.....	90
Configuration with Pushbutton Display .....	90
Calibration with Pushbutton Display .....	93
Calibration using Auto Tune .....	94
Correct for Over Travel.....	96
Adjust Input Signal Range .....	96
Configuring with ValVue ESD .....	97
Starting ValVue ESD/ESDVue .....	97
Check-out with a HART® Handheld Communicator .....	98

6. Using the Digital Interfaces .....	101
Overview.....	101
Local Display and Pushbuttons .....	101
HART® Handheld Communicator .....	102
ValVue ESD .....	102
Pushbuttons and Local Display .....	103
Accessing Pushbuttons .....	105
Pushbutton Locks and Configuration-Lock Jumper .....	105
Display Menus.....	107
NORMAL Operating Mode and MANUAL Mode Menus.....	107
Configure Menu.....	108
Calibration Menu .....	110
PST Configuration Menu .....	111
VIEW DATA Menu.....	112
PST CONF (VIEW DATA) Menu .....	114
VIEW ERR.....	115
Clear Error.....	116
FAILSAFE Mode.....	116
Handheld Communicator.....	117
ValVue ESD .....	118
DD Navigation.....	119
7. Partial Stroke Testing .....	121
Overview.....	121
Partial Stroke Test Diagnostics .....	122
PST Configuration.....	122
PST Configuration with Display Menu.....	122
PST Setup with ValVue ESD.....	124
PST Data from ESDVue .....	124
8. Operation and Maintenance .....	127
Operational Overview.....	127
SVI II ESD Applications and Designated Safety Function Activation.....	128
Additional Features .....	129
Physical and Operational Description .....	130
SVI II ESD Components.....	131
Electronics Module .....	131
Output Switches.....	133
Pneumatic Module.....	137
Optional Display and Pushbuttons .....	138
SVI II ESD Maintenance.....	138
Repair and Replacement.....	138
Factory Notification.....	139
Display Cover Removal and Installation.....	139
Upgrading Firmware.....	141
Tools Required .....	141
Installing Firmware Upgrade .....	141

9. Troubleshooting .....	143
Overview .....	143
Internal Diagnostics.....	143
FAILSAFE Mode .....	144
Accessing Diagnostic Information.....	144
Error Messages on LCD.....	145
Positioner Fault Messages .....	145
Return to Normal Operation.....	145
VIEW ERR Diagnostics Messages.....	146
Fault Matrix.....	147
Troubleshooting with ESDVue .....	161
Appendix A. Specifications and References .....	163
Physical and Operational Specifications .....	163
Models and Applications.....	169
Hazardous Area Certifications .....	169
SVI II ESD Models.....	172
Appendix B. Installing an SVI II ESD in a Natural Gas Environment .....	173
Remote Actuator Vent Gas Connection .....	175
Remote Gas Piping.....	175
Single Acting Installation.....	175
Appendix C. HART® Wiring Configurations .....	177
Overview .....	177
System Connections.....	177
HART® Wiring Guidelines .....	179
SVI II ESD Setups .....	180
Grounding Practices.....	182
Compliance Voltage in Single Drop Current Mode .....	183
Wire Size and Conduit.....	184
HART® Physical Layer Compliance of the Control System.....	185
Impedance Constraints .....	185
Noise Constraints .....	185
Cabling and Interconnection Requirements.....	186
Capacitance vs. Length of Cable for HART® .....	186
HART® Filter Required for Certain Control System Output Circuits .....	186
Split Range Applications.....	187
Setting Loop Addresses for Split Range Systems.....	187
Multiple Output Circuit Control System.....	189
Isolators .....	190
Supplemental Power Supply .....	192
Verify Wiring and Connections.....	192
Required Practices for Explosion Proof Installations .....	194
Clarification of Terminology .....	194
Recommended Practice for Severe or Humid Environments.....	194



HART® DCV Setup.....	195
HART® Module Positions.....	195
Field Wiring .....	195
Appendix D. HART® Communications with Intrinsic Safety .....	197
Overview.....	197
HART® Barrier Compliance .....	198
Output Channel Isolation.....	199
HART® Filter Requirements.....	199
Modem and Computer Use in Intrinsically Safe Circuits.....	201
MACTek® Intrinsically Safe modem, Model 010005.....	201
MACTek® Warning .....	201
Use of Hand-held Communicators In Intrinsically Safe Circuits .....	201
Appendix E. Air to Open and Air to Close Actuators .....	203
Actuator Action.....	203
Appendix F. Air Supply Requirements .....	207
Appendix G. Adjusting Speed of Response .....	209
Appendix H. Glossary .....	211
Appendix I. Determining an SVI Positioner Compliance Voltage in a Control System .....	219
Compliance Test Setup .....	219
Appendix J. Burst Mode Operations .....	221

*This page intentionally left blank.*

# List of Figures

1	SVI II ESD.....	29
2	ValVue ESD CD Browser .....	33
3	Software Choice.....	34
4	Install Shield Wizard.....	34
5	License Agreement.....	35
6	Choose Destination Location.....	35
7	Ready to Install.....	36
8	ValVue ESD CD Browser .....	37
9	Software Choice.....	38
10	PRM Plug-In Main Screen.....	38
11	PRM Central Server License Agreement.....	39
12	PRM Central Server Destination Folder .....	39
13	PRM Central Server Database Directory Destination Folder.....	40
14	Ready to Install.....	41
15	PRM Central Server Dialog .....	41
16	PRM Central Server Dialog II.....	41
17	PRM Central Server Dialog III .....	42
18	Database Directory Reminder.....	42
19	ValVue ESD CD Browser .....	43
20	Software Choice.....	44
21	PRM Plug-In Main Screen.....	44
22	Install Shield PRM Plug-In .....	45
23	PRM Plug-In License Agreement.....	45
24	PRM Plug-In Destination Folder .....	46
25	Choose Folder .....	46
26	PRM Plug-In Client Database Location Destination Folder.....	47
27	Choose Folder .....	47
28	Ready to Install.....	48
29	Owner and Product Key Registration Window.....	49
30	Applying Owner and Product Key Information .....	50
31	Software and Mux Key Window .....	50
32	Launching Registration Window.....	51
33	Registration Window .....	51

34	Save Registration Information.....	52
35	Registration File Saved Dialog.....	52
36	Registration Email Sent Dialog.....	53
37	Entering Software Key.....	53
38	Entering Mux Unlock Key.....	54
39	Successful Registration Message.....	54
40	SVI II ESD Exploded View.....	57
41	SVI II ESD Dimensions.....	58
42	Camflex with Mounting Bracket (Side View).....	63
43	Namur 20/30 mm Mounting Kit.....	66
44	Namur 50 mm Mounting Kit.....	67
45	Magnet Holder for Reciprocating Valves.....	68
46	Reciprocating Valve Mounting Bracket.....	68
47	Reciprocating Linkage.....	69
48	Lever for Model 87/88 Multispring Actuator.....	70
49	ValVue ESD for Checking Magnet Position.....	72
50	Air Ports on Single Acting PST Controller.....	74
51	Analog Safety Demand (ASD) Configuration.....	77
52	Discrete Safety Demand (DSD) Configuration.....	77
53	Analog with Discrete Safety Demand (A/DSD) Configuration.....	78
54	Connections to ASD Electronics Module (via Terminal Board).....	83
55	Connections to DSD Electronics Module (via Terminal Board).....	84
56	Connections to A/DSD Electronics Module (via Terminal Board).....	84
57	SVI II ESD Pneumatic and Display Covers.....	87
58	Configuration Pushbutton Guide.....	92
59	ValVue ESD Icon.....	97
60	SVI II ESD HART® Communicator Connections.....	98
61	SVI II ESD Display.....	103
62	NORMAL Operation and MANUAL Menu Structures.....	107
63	CONFIGure Menu.....	108
64	CALIBration Menu.....	110
65	PST CONFIGuration Menu.....	111
66	VIEW DATA Menu.....	113
67	PST CONFIGuration (VIEW DATA) Menu.....	115
68	View Err Menu.....	115
69	FAILSAFE Menu.....	117
70	DD Navigation.....	119
71	PST Configuration Pushbutton Menu.....	123
72	PST Diagnostic Graph Example.....	124
73	PST Benefits.....	125
74	Block Diagram with I/P Converter and Pressure Sensor.....	130
75	Switch Installation Drawing without Load: Configuration Not Allowed.....	133
76	Switch Installation Drawing: Correct Configuration with Load.....	134
77	DCS Switches Wiring Options.....	135
78	Pneumatic Module with Single Acting Relay.....	137
79	SVI II ESD Pneumatic and Display Covers.....	139

80	SVI II ESD Model Numbering.....	172
83	General Purpose and Explosion Proof Installation.....	181
84	Intrinsically Safe Installation .....	182
85	Selecting Set Options - Tools Menu on Connected Devices Screen .....	188
86	Selecting Set Options - Right Click on Connected Devices Screen .....	188
87	ValVue ESD Setup Options for Multidrop.....	189
88	Split Range with Isolator .....	191
89	Split Range with Supplemental Power Supply - Non-Hazardous.....	193
90	HART® Device in DCV Application.....	195
91	Intrinsically Safe Installation with Zener Barrier and HART® Filter.....	198
92	Intrinsically Safe Installation with Galvanic Isolator .....	200
93	ATO and ATC Action with Linear Positioner Characteristics.....	204
94	ATO and ATC Action in Percentage of Positioner Characteristics.....	205
95	Compliance Voltage Test Setup.....	219
96	Burst Mode Configuration .....	221

*This page intentionally left blank.*

# List of Tables

1	Proof Test Steps .....	26
2	ValVue Software Installation Sizes .....	31
3	Software Requirements.....	31
4	SVI II ESD Installation Steps .....	59
5	Travel Sensor Alignment.....	65
6	Reciprocating Valve Mounting Hole and Turnbuckle Length .....	70
7	Pneumatic Connections/Air Supply Requirements .....	73
8	SVI II ESD Models and Functionality .....	83
9	VIEWDATA Settings.....	91
10	Rough Guide to Effects of Changing PID Values .....	95
11	Pushbutton Display Menus.....	104
12	Pushbutton Lock Security Level.....	105
13	SVI II ESD Fault Matrix .....	147
14	Environmental Specifications .....	163
15	Safety Rated Inputs .....	164
16	Operational Specifications.....	164
17	Input Signal, Power, and Display Specifications .....	165
18	Construction Material Specifications .....	165
19	System Connectivity.....	166
20	Pneumatics Single Acting Standard Flow .....	166
21	Control Valve Mounting System .....	167
22	ESD and Diagnostic Capabilities .....	167
23	Device ID Information .....	168
24	Burst Mode Data Return .....	168
25	SVI II ESD Model Features.....	169
26	SVI II ESD Physical Attributes .....	169
28	CSA International Certifications.....	170
29	FM Approvals.....	170
30	Temperature Class.....	170
27	ATEX Approvals.....	170
31	Immunity Performance.....	171
32	Radiation Performance .....	171
33	Compliance Voltage for Single Channel Zener with 22 AWG Cable Installation .....	183

34	Compliance Voltage for Galvanic Isolator with 22 AWG Cable Installation.....	183
35	Compliance Voltage for No Barrier with HART® Filter and Resistor and 18 AWG Cable .....	184
36	Supplemental Voltage for Split Range .....	192
37	Expected Voltage Range at Positioner Terminals .....	220



# 1. Safety Information

## Introduction

This section provides information necessary to design, install, verify and maintain a Safety Instrumented Function (SIF) utilizing a Masoneilan Smart Valve Interface, SVI II ESD. This manual provides necessary requirements for meeting the IEC 61508 or IEC 61511 functional safety standards.

## Terms and Abbreviations

The following terms and abbreviations are related to safety functions of the SVI II ESD and are used throughout this document.

<i>Safety</i>	Freedom from unacceptable risk of harm.
<i>Functional Safety</i>	The ability of a system to carry out the actions necessary to achieve or to maintain a defined safe state for the equipment / machinery / plant / apparatus under control of the system.
<i>Basic Safety</i>	The equipment must be designed and manufactured such that it protects against risk of damage to persons by electrical shock and other hazards and against resulting fire and explosion. The protection must be effective under all conditions of the nominal operation and under single fault condition.
<i>Safety Assessment</i>	The investigation to arrive at a judgment - based on evidence - of the safety achieved by safety-related systems.
<i>Fail-Safe State</i>	State where the SVI II ESD is de-energized and has exhausted Actuator 1 in a single acting configuration or has caused Actuator 1 to be at an equal or lower pressure than Actuator 2 in a dual acting configuration.
<i>Fail Safe</i>	Failure that causes the valve to go to the defined fail-safe state without a demand from the process.
<i>Fail Dangerous</i>	Failure that does not respond to a demand from the process (i.e. being unable to go to the defined fail-safe state).

<i>Fail Dangerous Undetected</i>	Failure that is dangerous and that is not being diagnosed by automatic stroke testing.
<i>Fail Dangerous Detected</i>	Failure that is dangerous but is detected by automatic stroke testing.
<i>Fail Annunciation Undetected</i>	Failure that does not cause a false trip or prevent the safety function but does cause loss of an automatic diagnostic and is not detected by another diagnostic.
<i>Fail Annunciation Detected</i>	Failure that does not cause a false trip or prevent the safety function but does cause loss of an automatic diagnostic or false diagnostic indication.
<i>Fail No Effect</i>	Failure of a component that is part of the safety function but that has no effect on the safety function.
<i>Low Demand Mode</i>	Mode, where the frequency of demands for operation made on a safety-related system is no greater than twice the proof test frequency.

## Acronyms

The following acronyms are related to safety functions of the SVI II ESD and are used throughout this document.

<i>FMEDA</i>	Failure Modes, Effects and Diagnostic Analysis
<i>HFT</i>	Hardware Fault Tolerance
<i>MOC</i>	Management of Change. These are specific procedures often done when performing any work activities in compliance with government regulatory authorities.
<i>PFDavg</i>	Average Probability of Failure on Demand
<i>PST</i>	Partial Stroke Test, a test used to detect failure modes in the positioner, actuator, and valve assembly.
<i>SFF</i>	Safe Failure Fraction, the fraction of the overall failure rate of a device that results in either a safe fault or an diagnosed unsafe fault.
<i>SIF</i>	Safety Instrumented Function, a set of equipment intended to reduce the risk due to a specific hazard (a safety loop).
<i>SIL</i>	Safety Integrity Level, discrete level (one out of a possible four) for specifying the safety integrity requirements of the safety functions to be allocated to the E/E/PE safety-related systems where Safety Integrity Level 4 has the highest level of safety integrity and Safety Integrity Level 1 has the lowest.
<i>SIS</i>	Safety Instrumented System – Implementation of one or more Safety Instrumented Functions. A SIS is composed of any combination of sensor (s), logic solver (s), and final element (s).

## Safety Symbols

Conventions used in this manual are as follows:

- *Italicized* letters are used when referencing a term used in the program display window.
- Italics is used for emphasis on important items.
- Fields where data is entered or user-entered data is *italicized*.
- Actions performed on buttons, checkboxes, etc. appear bolded. For example: Click **Done**.

### NOTE



*Indicates important facts and conditions.*

### CAUTION



*Indicates a potentially hazardous situation, which if not avoided may result in property damage or data loss.*

### WARNING



*Indicates a potentially hazardous situation, which if not avoided may result in death or serious injury.*

## Related Literature

Listed below are documents related to the SVI II ESD.

<i>TUV Certificate No.</i>	SAS0016/07, Vers. 1.0
<i>Hardware Document</i>	<ul style="list-style-type: none"><li>□ SVI II ESD Quick Start Guide, MN-SVI-ESD_QSG-GEA19520</li><li>□ SVI II ESD SIL 3 Partial Stroke Test Device, BW500-ESD</li></ul>
<i>Guidelines/ References</i>	<ul style="list-style-type: none"><li>□ Safety Integrity Level Selection – Systematic Methods Including Layer of Protection Analysis, ISBN 1-55617-777-1, ISA</li><li>□ Control System Safety Evaluation and Reliability, 2nd Edition, ISBN 1-55617-638-8, ISA</li><li>□ Safety Instrumented Systems Verification, Practical Probabilistic Calculations, ISBN 1-55617-909-9, ISA</li></ul>

## Reference Standards

Listed below are Functional Safety reference standards related to the SVI II ESD:

- IEC 61508: 2000 – Functional safety of electrical/electronic/programmable electronic safety-related systems
- ANSI/ISA 84.00.01-2004 (IEC 61511 Mod.) Functional Safety – Safety Instrumented Systems for the Process Industry Sector

## Masoneilan Help Contacts

- Email: [svisupport@bhge.com](mailto:svisupport@bhge.com)
- Phone: 888-SVI-LINE (888-784-5463)

## SVI II ESD Device Description

An ESD valve is a valve that operates to ensure that the process is brought to its safe state. During normal operation, these ESD valves are typically energized to stay open (ATO). In case of an unsafe situation, the ESD valve is de-energized by the Safety System. The SVI II ESD device performs this shutdown function for Safety Instrumented Functions (SIF) that require field devices to be certified for safety related applications according to IEC61508 as certified by TUV for use up to SIL3 with an HFT of 0 in low demand applications. The built-in microprocessor is used for valve diagnostics only. The microprocessor has no direct role in performing the designated safety function therefore the SVI II ESD is considered a Type A device.

The SVI II ESD is a valve controller which mounts on a pneumatically actuated valve assembly. Its role is to position an emergency shutdown valve to 0% or 100% with a PFDavg in accordance with IEC61508 for SIL3 application.

Because of its capability of monitoring data from its embedded sensors, the SVI II ESD is capable of validating the health of its integral components. In addition, due to the ability of partially stroking, the ESD valve while in normal operations (energized to stay open - ATO); it becomes possible to validate the health of the valve and actuator assembly. Configurable time based testing of the ESD valve reduces the PFDavg by detecting dangerous failures.

## Designing an SIF Using an SVI II ESD

The following must be taken into consideration when designing a SIF (Safety Instrumented Function) using the SVI II ESD:

- Safety Function
- Environmental Limits
- Design Verification
- SIL Capability
- Connecting the SVI II ESD to the SIS Logic-Solver
- General Requirements

### Safety Function

When de-energized, the SVI II ESD moves to its fail-safe position. For a single-acting PST controller the safe state is when the port *Actuator 1* is exhausted to a pressure less than 1 PSIG (0.069 bar, 6.9 kPa). The valve actuation must automatically move the valve to the safe state when the digital valve controller falls in safe state.

The SVI II ESD is intended to be part of final element subsystem, as per IEC 61508, and the achieved SIL level of the function must be verified by the function designer.

### Environmental Limits

The designer of a SIF must check that the product is rated for use within the environmental limits as stated in Table 14 on page 163.

### Application Limits

Listed below are the application limits for the SVI II ESD installed in a SIF:

- The application of the SVI II ESD is limited for SIF where the safe state is the de-energized state (shutdown) of the valve. The PST Controller can be operated with either one of two control signals: 4 - 20 mA or 0 - 24 VDC.
- With a 4 - 20 mA control signal, normal operation is with a 20 mA current loop signal to the PST controller. A shutdown command is issued by bringing the current to 5.6 mA or lower.
- With a 0 - 24 VDC control signal, normal operation is with a 24 VDC signal applied to the PST controller. A shutdown command is issued by opening the loop or bringing the control signal to 3 VDC or lower.

## Design Verification

The following describes the design verification criteria for the SIF and the SVI II ESD:

- A detailed Failure Mode, Effects, and Diagnostics Analysis (FMEDA) report is available from the factory. This report details all failure rates and failure modes as well as the expected lifetime.
- The achieved Safety Integrity Level (SIL) of an entire Safety Instrumented Function (SIF) design must be verified by the designer by means of PFDavg calculation, considering redundant architectures, proof test interval, proof test effectiveness, any automatic diagnostics, average repair time and specific failure rates of all products included in the SIF. Each subsystem must be checked to assure compliance with minimum hardware fault tolerance (HFT) requirements. The exida exSILentia<sup>®</sup> tool is recommended for this purpose as it contains accurate models for the SVI II ESD and related failure rates.
- When using an SVI II ESD in a redundant configuration, include a common cause factor of 5% in safety integrity calculations.
- The failure rate data listed in the FMEDA report is valid only for the useful life time of an SVI II ESD. The failure rates sometimes increase after this time period. Reliability calculations based upon the data listed in the FMEDA report for mission times beyond the lifetime can yield results too optimistic, i.e. the calculated Safety Integrity Level will not be achieved.

## SIL Capability

The SVI II ESD meets SIL 3 requirements as outlined below.

### Systematic Integrity

The product has met manufacturer design process requirements of Safety Integrity Level (SIL) 3. These are intended to achieve sufficient integrity against systematic errors of design by the manufacturer. A Safety Instrumented Function (SIF) designed with this product must not be used at a SIL level higher than the statement without *prior use* justification by end user or diverse redundant technology in the design.

### Random Integrity

The SVI II ESD's safety critical function is maintained by a Type A Device. Therefore based upon the SFF > 90%, when the SVI II ESD is used as the sole component in a final element subassembly, a design can meet SIL 3 @ HFT=0.

When the final element assembly consists of many components (SVI II ESD, quick exhaust valve, actuator, isolation valve, etc.) the SIL must be verified for the entire assembly taking into consideration failure rate of each component. This analysis must account for any hardware fault tolerance and architecture constraints.

## Safety Parameters

For detailed failure rate information refer to the Failure Modes, Effects and Diagnostic Analysis Report for the SVI II ESD available from the factory.

## SIL Certification

This product guarantees to respond to commanded trip signal with a PFD in accordance to IEC61508 SIL3

Capable of partially stroking the valve using one of the following initiation methods, that will be IEC61508 SIL2 certified:

- Built-In Scheduler within the SVI II ESD
- Locally with an external pushbutton
- Locally with built-in pushbutton
- HART® command
- Analog Input current threshold

## Connecting the SVI II ESD to the SIS Logic Solver

When connecting the SVI II ESD to the SIS logic solver follow the guidelines below.

- The SVI II ESD is connected to the safety rated logic solver which is actively performing the safety function. Connections must be made as per the instructions supplied by the safety rated logic solver.
- The output rating of the I/O module has to meet or exceed the electrical specifications of the SVI II ESD as referenced in ES-727 in the SVI II ESD Quick Start Guide, MN-SVI-ESD\_QSG-GEA19520.

## General Requirements

The following general requirements for the SVI II ESD must comply to the following:

- The system response time shall be less than process safety time. The SVI II ESD switches to its fail safe state in less than 100ms. *Response time is actuator dependent.*
- The end user must add the SVI II ESD response time to actuator/valve response to obtain overall response time.
- All SIS components, including the SVI II ESD, must be operational before process start-up. The internal diagnostic test monitoring SVI II ESD for faults has a one hour test interval. This test does not partial stroke the valve.
- In order to use the PST as an automatic diagnostic tool the PST shall be scheduled (using ValVue ESD) to run at least once per month or ten times within the expected hazard demand interval, whichever comes first. Detailed failure rate data is specified in the FMEDA report available from the factory.
- You must verify that the SVI II ESD is suitable for use in safety applications by confirming that SVI II ESD's nameplate is properly marked.
- Personnel performing maintenance and testing on the SVI II ESD has to be qualified to do so.
- Results from the PST and proof tests shall be recorded and periodically reviewed.
- The useful life of the SVI II ESD is discussed in the Failure Modes, Effects and Diagnostic Analysis Report for the SVI II ESD.



## Installation

All installation related issues are outlined below.

### SVI II ESD Installation Configurations

Refer to “SVI II ESD Configurations” on page 76

### Physical Location and Placement Guidelines

Refer to “Physical Location and Placement Guidelines” on page 60

### Pneumatic Connections

Refer to “Pneumatic Connections” on page 73 of this manual.

### Electrical Connections

Refer to “Electrical Connection Guidelines” on page 75

## Operation, Setup, Commissioning

Refer to “Configuration and Calibration” on page 89

## Maintenance

Refer to “SVI II ESD Maintenance” on page 138.

## Diagnostics

The SVI II ESD provides several types of diagnostic information:

- Continuous device diagnostics
- Internal diagnostics that run every hour and require no user configuration
- Partial Stroke Testing (PST) diagnostics

### PST

You can configure and run PST at any time. For more information on PST refer to “Partial Stroke Testing” on page 121

## Proof Test

You can also manually run a proof test. The objective of proof testing is to detect failures within an SVI II ESD and ESD valve that are not detected by any automatic diagnostic of the system. Of main concern are undetected failures that prevent the safety instrumented function from performing its intended function.

Proof testing frequency or proof test interval, has to be determined in reliability calculations for the safety instrumented functions to which SVI II ESD is applied. The proof tests must be performed more frequently or as frequently as specified in the calculation in order to maintain the required safety integrity of the safety instrumented function.

The following proof test is recommended. Report any detected failures that compromise functional safety to the factory.

**Table 1 Proof Test Steps**

Step	Action
1	Read the SVI II ESD data record using a HART <sup>®</sup> handheld device or ValVue ESD software. Solve any active faults before proceeding.
2	Bypass the valve, or isolate or take other appropriate action to avoid a false trip, following company Management of Change (MOC) procedures
3	Inspect the SVI II ESD for dirty or clogged ports and other physical damage
4	De-energize the SVI II ESD and observe that the actuator and valve move. Energize the SVI II ESD after the valve has moved to its full stroke length. An accumulated value of 100% travel = 1 stroke. The travel does not need to occur in one movement.
5	Inspect the SVI II ESD for dirt, corrosion or excessive moisture. Clean if necessary and take corrective action to properly clean the air supply. It has to be done in order to avoid incipient failures due to dirty air.
6	Record any failures in your company's SIF inspection database. Restore the loop to full operation.
7	Remove bypass or otherwise restore normal operation

This test detects approximately 99% of possible DU failures in the SVI II ESD (Proof Test Coverage).

The person (s) performing the proof test of an SVI II ESD must be trained in SIS operations, including bypass procedures, maintenance and company Management of Change procedures. No special tools are required.

## SVI II ESD Product Safety

The SVI II ESD is intended for use with industrial compressed air or sweet natural gas systems only. Ensure that an adequate pressure relief provision is installed when the application of system supply pressure may cause peripheral equipment malfunctioning. Installation must be in accordance with local and national compressed air and instrumentation codes.

### *General installation, maintenance or replacement*

- Products must be installed in compliance with all local and national codes and standards by qualified personnel using safe site work practices. Personal Protective Equipment (PPE) must be used per safe site work practices.
- Ensure proper use of fall protection when working at heights, per safe site work practices. Use appropriate safety equipment and practices to prevent the dropping of tools or equipment during installation.
- Under normal operation, compressed supply gas is vented from the unit to the surrounding area, and may require additional precautions or specialized installations.

### *Explosion/ flame proof installations*

Products certified as explosion proof or flame proof equipment or for use in hazardous area installations **MUST BE**:

- Installed, put into service, used and maintained in compliance with national and local regulations and in accordance with relevant standards recommendations for potentially explosive atmospheres.
- Used only in situations that comply with the certification conditions shown in this document and after verification of their compatibility with the zone of intended use and the permitted maximum ambient temperature
- Installed, put into service and maintained by qualified and competent professionals who have undergone suitable training for instrumentation used in areas with potentially explosive atmospheres.

#### **WARNING**



*Before using these products with fluids/compressed gases other than air or for non-industrial applications, consult the factory. This product is not intended for use in life support systems.*

#### **WARNING**



*Do not use damaged instruments.*

**WARNING**



*Installation in poorly ventilated confined areas, with any potential of gases other than oxygen being present, can lead to a risk of personnel asphyxiation.*

Use only genuine replacement parts which are provided by the manufacturer, to guarantee that the products comply with the essential safety requirements of the European Directives mentioned on the front cover.

Changes to specifications, structure, and components used may not lead to the revision of this manual unless such changes affect the function and performance of the product.

# 2. Introduction

## ValVue ESD Overview

Masoneilan's ValVue ESD software is a Human-Machine Interface (HMI) software tool that provides a powerful interface to Masoneilan's SVI II ESD used in a Safety Instrumented System (SIS).

ValVue ESD is used to configure, calibrate and perform partial stroke testing and valve diagnostics with the SVI II ESD utilizing HART® communications protocol.

Using ValVue ESD you can:

- Monitor SVI II ESD Operation
- Quickly Set Up the SVI II ESD
- Advanced SVI II ESD Set Up
- Calibrate the SVI II ESD
- Configure or Run Partial Stroke Test (PST)
- Check the SVI II ESD Status
- Perform Diagnostics on SVI II ESD



Figure 1 SVI II ESD

The SVI II ESD LCD pushbutton display enables local operations for calibration and configuration functions. Remote operations can be performed with ValVue ESD software or any HART® Registered host interface pre-loaded with the Device Description file (DD) for SVI II ESD.

The SVI II ESD is supplied with Masoneilan's ValVue ESD software. The user-friendly interface facilitates the setup and diagnostics of a SIS control valve.

## ValVue ESD Software

ValVue ESD software is able to quickly and easily set up the SVI II ESD. In addition you can also monitor operation and diagnose problems using ValVue ESD's advanced diagnostic capabilities.

### ValVue ESD Trial Version

The SVI II ESD is supplied with ValVue ESD software. For a duration of 60 days after the initial installation, ValVue ESD provides the capability of configuring, calibrating, diagnosing, device cloning, trending and much more. After the 60 day trial period ValVue ESD must be registered in order to keep on using it.

ValVue ESD is a user-friendly, graphical interface that allows an efficient setup of an SVI II ESD mounted on any control valve assembly. Because of its What-You-See-Is-What-You-Get (WYSIWYG) software environment, it is a very friendly user-interface.

ValVue ESD functionality includes:

- Setup Wizard
- Remote display of valve position, actuator pressure(s)
- Set point calibration parameters
- Set point configuration parameters
- Set point status/error indicators
- Input/Output configuration
- Remote calibration of the SVI II ESD
- Remote configuration of the SVI II ESD
- Remote operation of the SVI II ESD
- Remote Partial Stroke Test (PST) configuration
- Remote running of Partial Stroke Test
- Partial Stroke Test Scheduling
- Saving and Viewing Historical data
- Backup and restore configuration (clone device)

- Trend setpoint, valve position, actuator pressure
- Display comparative test results
- Perform diagnostic test procedures

### System Requirements

Listed below are the hardware and software requirements for the computer used with ValVue ESD:

#### Hardware

<i>Processor</i>	PC with minimum 1 GHz Intel Pentium or compatible
<i>RAM</i>	Minimum 1 G
<i>Disk</i>	Depends on product
<i>Modem</i>	HART <sup>®</sup> modem and appropriate cables
<i>Port</i>	Serial or USB

**Table 2 ValVue Software Installation Sizes**

Product	Application Component	Database Component	Total Installation Size
ValVue ESD	15M	30M minimum <sup>1</sup>	45 Meg
PRM Central ValVue ESD	15M	30M minimum <sup>1</sup>	45 Meg
PRM PLUG-IN ValVue ESD	15M	N/A	15 Meg

<sup>1</sup> Assuming 100 devices, 1 PST/month for 5 years

#### Software

**Table 3 Software Requirements**

OS:	Windows XP SP2 Window Server 2003 with Service Pack 1, Window Server 2003 R2, Windows Server 2008 and Windows 7
PRM:	PRM R3.x

**NOTE**



*PRM is NOT required for Standalone installations.*

## Installing ValVue ESD

ESDVue is shipped on a CD included with every SVI II ESD. Place the CD in the computer CD drive and run *ValVue ESD Installer.exe*. Follow the instructions of the installer program.

## Advanced and Online Diagnostics

One of the important safety features of the SVI II ESD is the ability to test functionality of the instrument. In addition to running a Partial Stroke Test (PST), ValVue ESD provides advanced diagnostic capabilities and allows you to test the SVI II ESD terminal board and pneumatics and to run extended testing on the actuator. The diagnostics area of the PST screen provides access to all the diagnostic testing, shows the results from current testing and allows you to load and view historical data.

All diagnostic tests are performed on the PST screen, in ValVue ESD. For more details on the use of ValVue ESD software, refer to the ValVue ESD User's Guide. Contact the factory or your local representative to obtain licensing information.

## Contact the Factory

For the most recent software visit our SVI II ESD web site at: [www.ge-energy.com/valves](http://www.ge-energy.com/valves).

## Available Models

There are three models of the SVI II ESD available:

- ASD - Analog Safety Demand; 2 Wire Analog Trigger, 4 - 20 mA signal, 2 wire installations with superimposed HART<sup>®</sup> communications
- DSD - Discrete Safety Demand; 2 Wire Discrete Trigger, 24 VDC, 2 wire installations with superimposed HART<sup>®</sup> communications
- A/DSD - Analog Setpoint with Discrete Safety Demand; 4 Wire Discrete Trigger, 4 - 20 mA signal, 2 wire installations with superimposed HART<sup>®</sup> communications for control system and 24 VDC 2 wire for Safety System.

## About This Manual

The SVI II ESD Instruction Manual is intended to help a Field Engineer install, setup, and calibrate an SVI II ESD in the most efficient manner possible. This manual also provides in-depth information on SVI II ESD software, digital interfaces, operation, intrinsic safety configurations, and specifications. If you experience problems that are not documented in this guide contact the factory or your local representative. Sales offices are listed on the back cover of this manual.



# 3. Software Installation and Setup

## Install ValVue ESD and PRM Plug-In

ValVue ESD is shipped on a CD with the purchase of an SVI II ESD. There are two components to install:

- “Installing ValVue ESD Software”
- “Installing the Yokogawa® PRM Plug-In” on page 37

### Installing ValVue ESD Software

To install the software:

1. Insert the CD into computer CD drive.

The CD browser launches (Figure 2).



Figure 2 ValVue ESD CD Browser

2. Select **INSTALL SOFTWARE** and a screen appears (Figure 3).

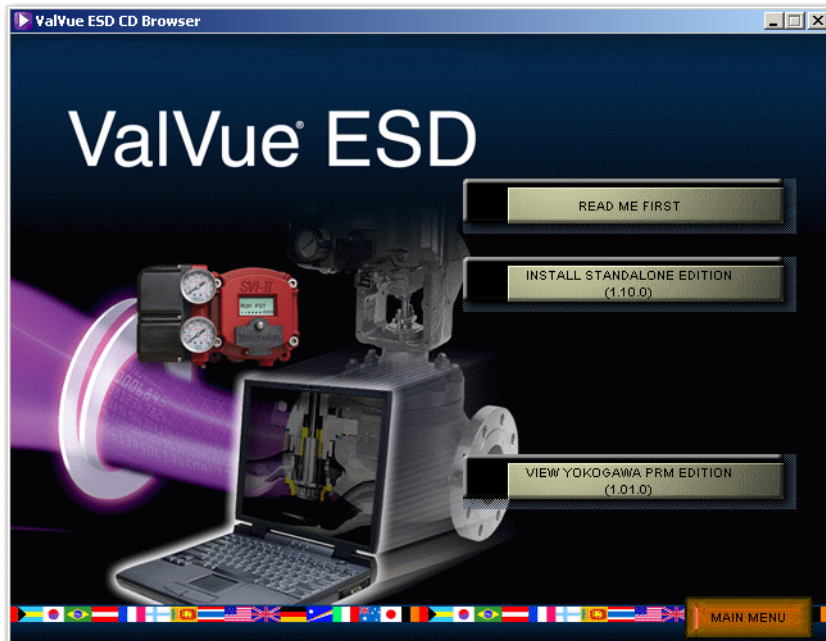

Figure 3 Software Choice

3. Click **INSTALL STANDALONE VERSION** and an *installShield* screen appears (Figure 4).

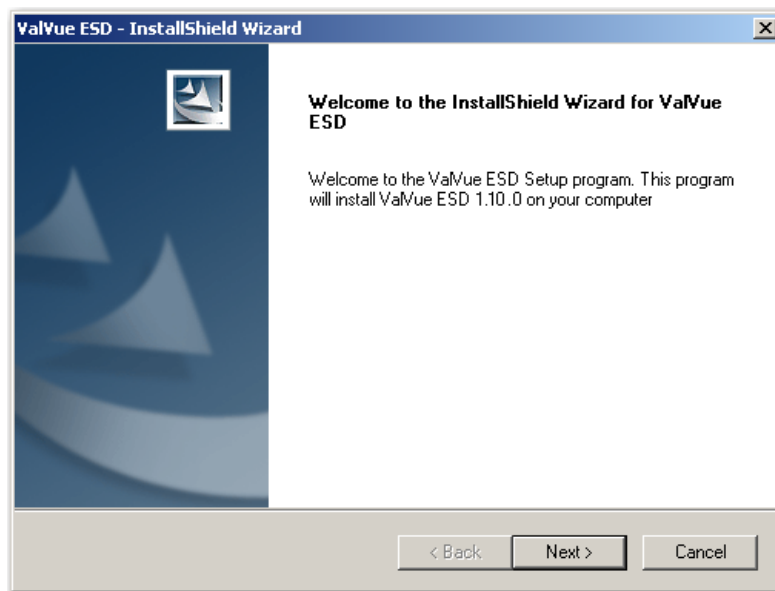
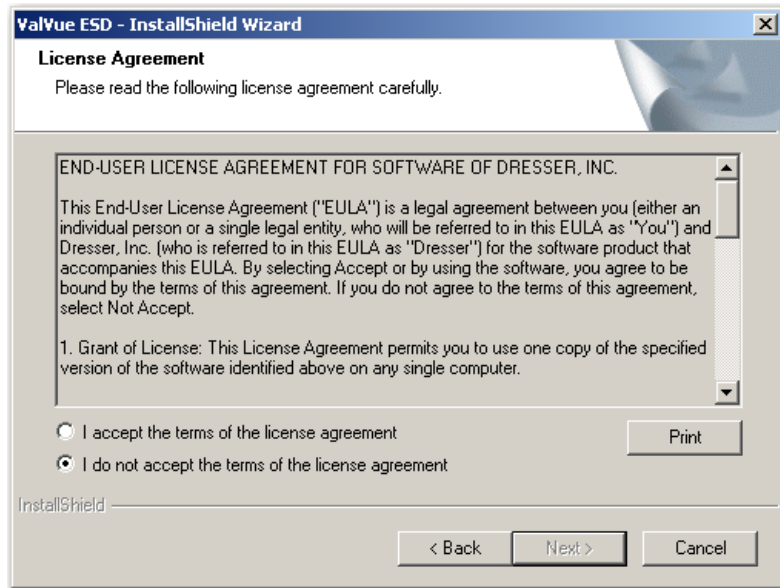

Figure 4 Install Shield Wizard

- Click **Next** and the *License Agreement* screen appears (Figure 5).



**Figure 5 License Agreement**

- Click the accept radio button, click **Next** and the *Choose Destination Location* screen appears (Figure 6).

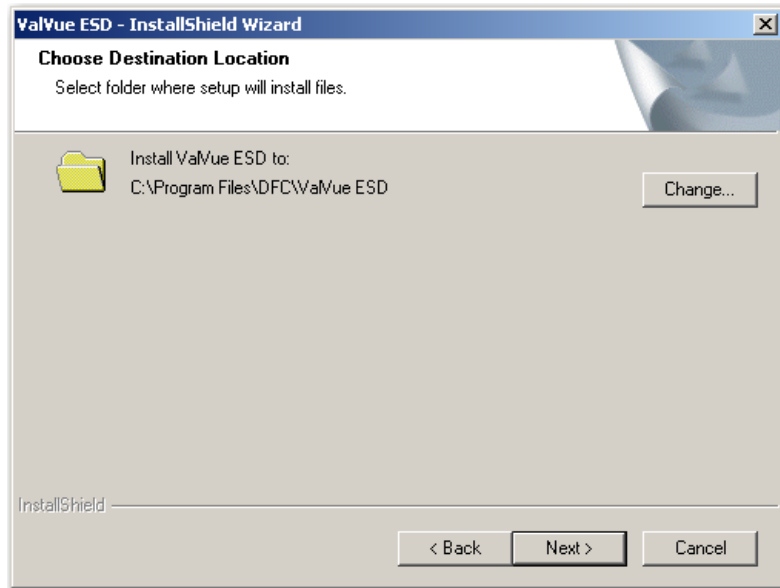
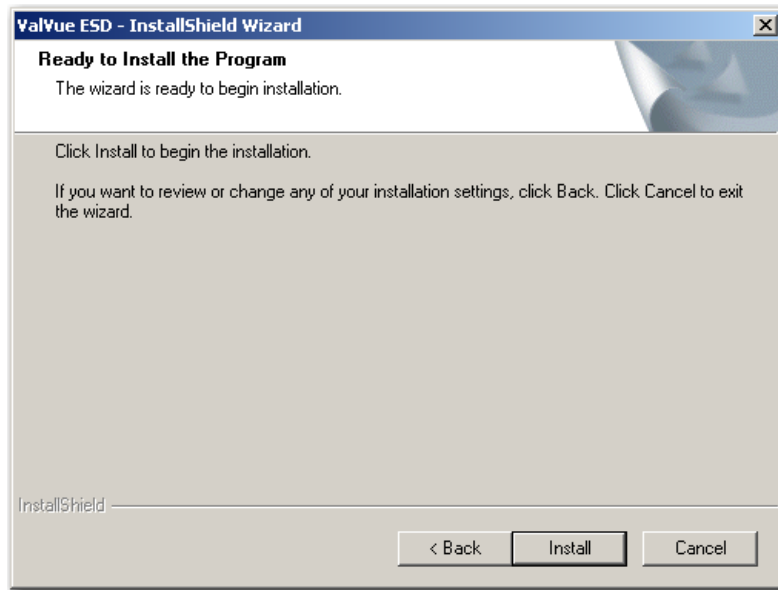

**Figure 6 Choose Destination Location**



Click **Change** to open the *Choose Folder* screen to navigate to and designate a non-default folder.

6. Click **Next** and a screen appears (Figure 7).



**Figure 7 Ready to Install**

7. Click **Install** and the *Setup Status* screen appears followed by *InstallShield Wizard Complete*.
8. Click **Finish**.

## Installing the Yokogawa® PRM Plug-In

This process consists of:

- “Installing Central Server”
- or
- “Installing Plug-In Client” on page 43

### Installing Central Server

This installs both the plug-in and the central database.

To install the software:

1. Insert the CD into computer CD drive and the CD browser launches (Figure 2).



Figure 8 ValVue ESD CD Browser

2. Select **INSTALL SOFTWARE** and a screen appears (Figure 9).

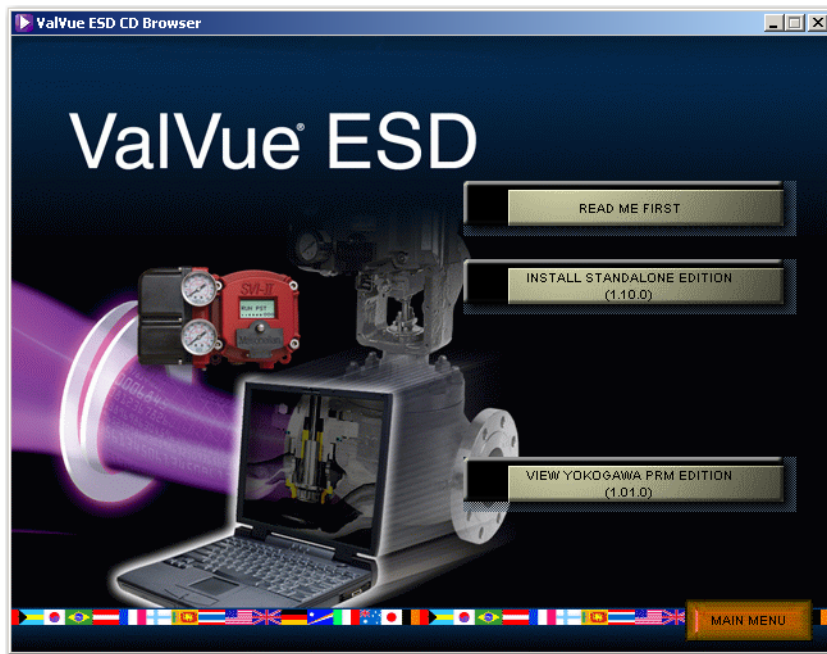

Figure 9 Software Choice

3. Click **VIEW YOKOGAWA PRM EDITION** and a screen appears (Figure 10).



Figure 10 PRM Plug-In Main Screen

4. Click **Install Central Server** and a screen appears.
5. Click **Next** and the *License Agreement* screen appears (Figure 11).

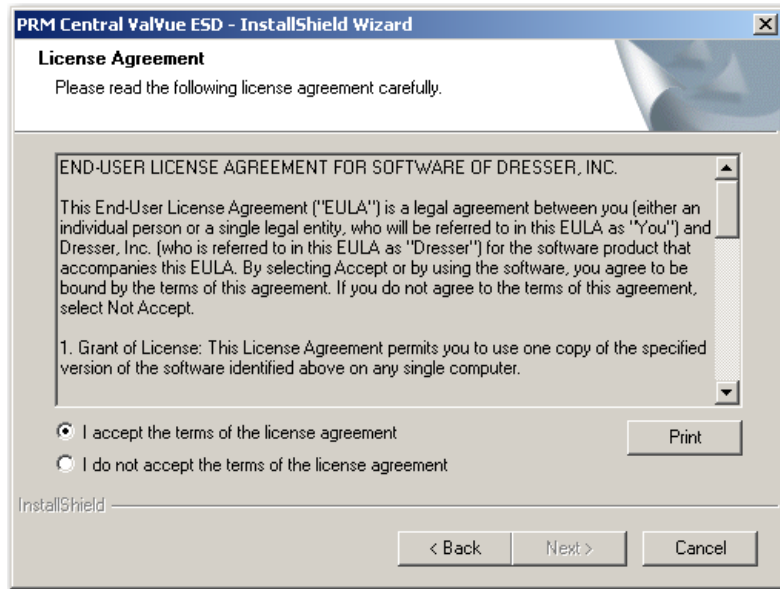

**Figure 11 PRM Central Server License Agreement**

6. Click the accept radio button, click **Next** and the *Choose Destination Location* screen appears (Figure 12).

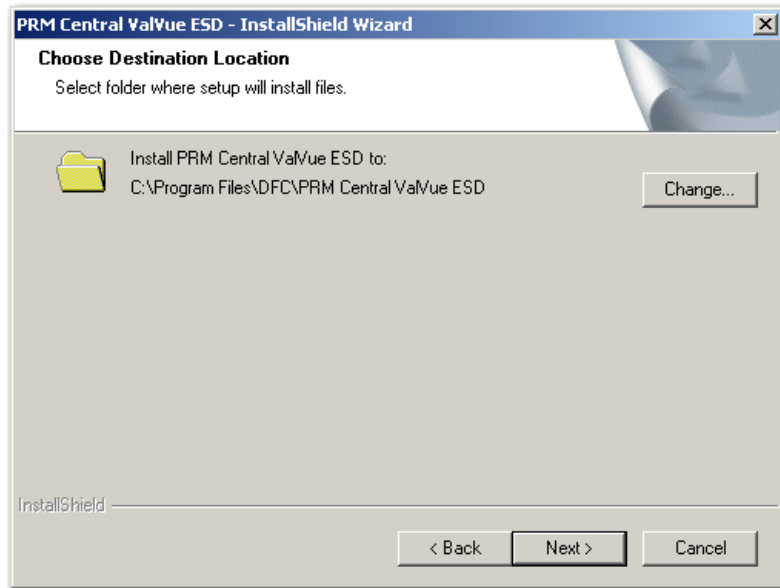

**Figure 12 PRM Central Server Destination Folder**



Click **Change** to open the Choose Folder screen to navigate to and designate a non-default folder.

7. Click **Next** and the screen appears (Figure 13).



Click **Change** to open the Choose Folder screen to navigate to and designate a non-default folder. Make a note of this machine and folder share name, ValVue ESD DATABASE as it is required when installing the PRM PLUG-IN ValVue. The installer also creates a data source for the database. If the database already exists, the installer updates the tables as necessary. No existing data is lost.

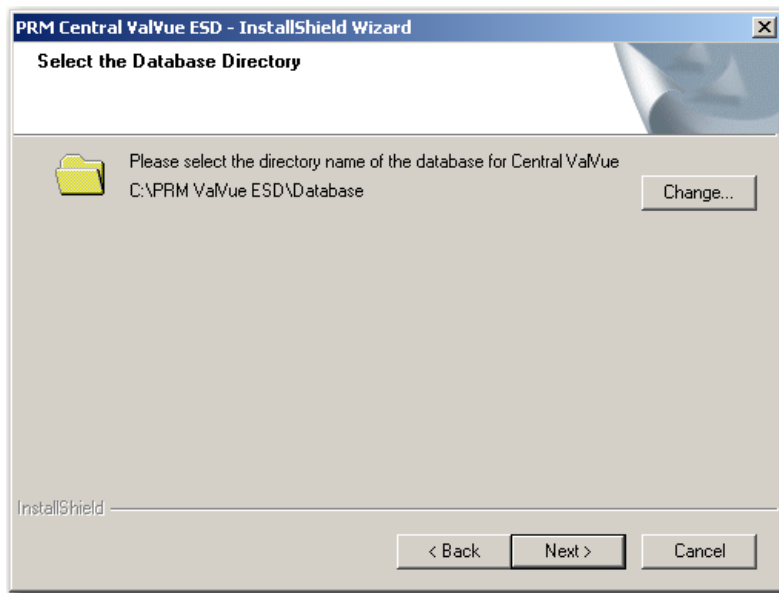
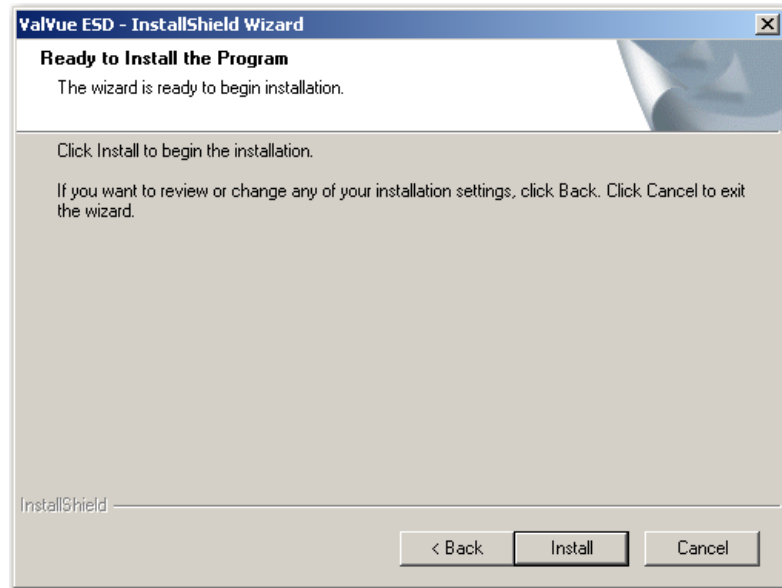

Figure 13 PRM Central Server Database Directory Destination Folder



8. Click **Next** and a screen appears (Figure 14).



**Figure 14 Ready to Install**

9. Click **Install** and the *Setup Status* screen appears followed by *InstallShield Wizard Complete*.
10. Click **Finish**.
11. A *Launch Service Install* dialog appears; click **OK** and a dialog appears (Figure 15).

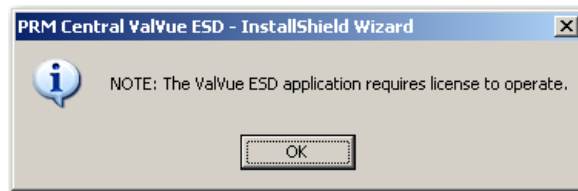

**Figure 15 PRM Central Server Dialog**

12. Click **OK** and another dialog appears (Figure 16).



**Figure 16 PRM Central Server Dialog II**

13. Click **OK** and another dialog appears (Figure 17).

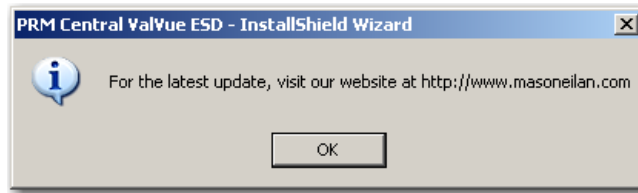

**Figure 17 PRM Central Server Dialog III**

14. Click **OK** and another dialog appears (Figure 18).

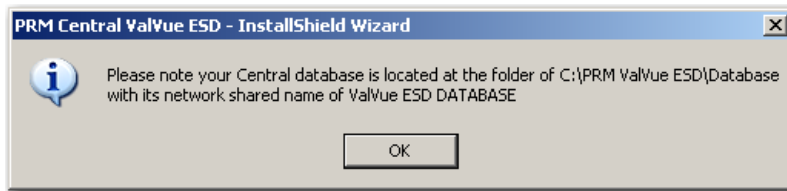

**Figure 18 Database Directory Reminder**

15. Click **OK**.

## Installing Plug-In Client

This installs the plug-in and the client software and a database. Install this application on every computer on which PRM Client is installed after PRM Central is installed for the particular PRM server. This application does not require registration.

To install the software:

1. Insert the CD into computer CD drive and the CD browser launches (Figure 19).



Figure 19 ValVue ESD CD Browser

2. Select **INSTALL SOFTWARE** and a screen appears (Figure 20).

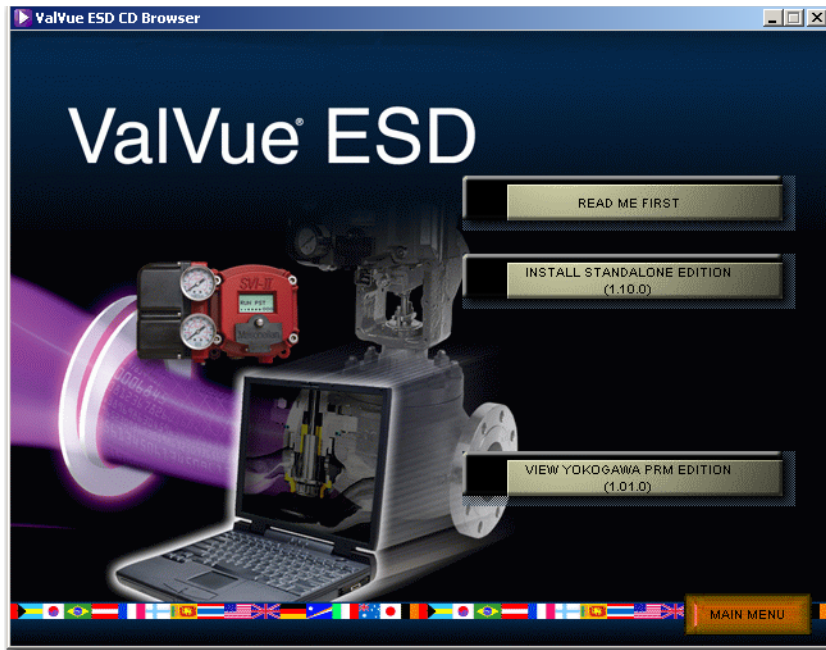

Figure 20 Software Choice

3. Click **VIEW YOKOGAWA PRM EDITION** and a screen appears (Figure 21).



Figure 21 PRM Plug-In Main Screen

4. Click **Install Plug-in Client** and a screen appears (Figure 22).

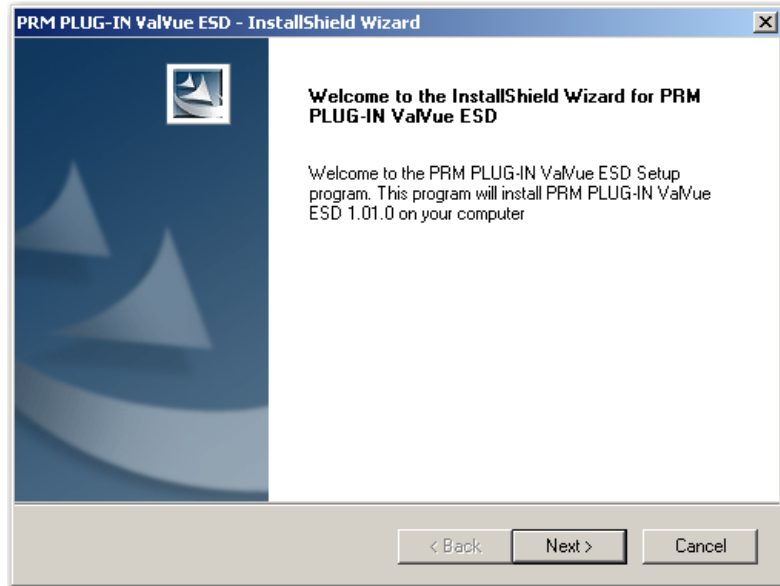

**Figure 22** Install Shield PRM Plug-In

5. Click **Next** and the *License Agreement* screen appears (Figure 23).

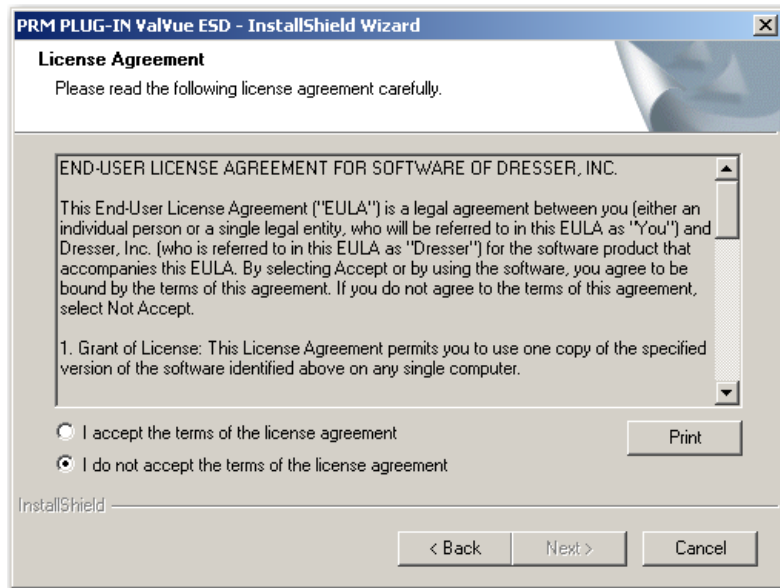

**Figure 23** PRM Plug-In License Agreement

6. Click the accept radio button, click **Next** and the *Choose Destination Location* screen appears (Figure 24).

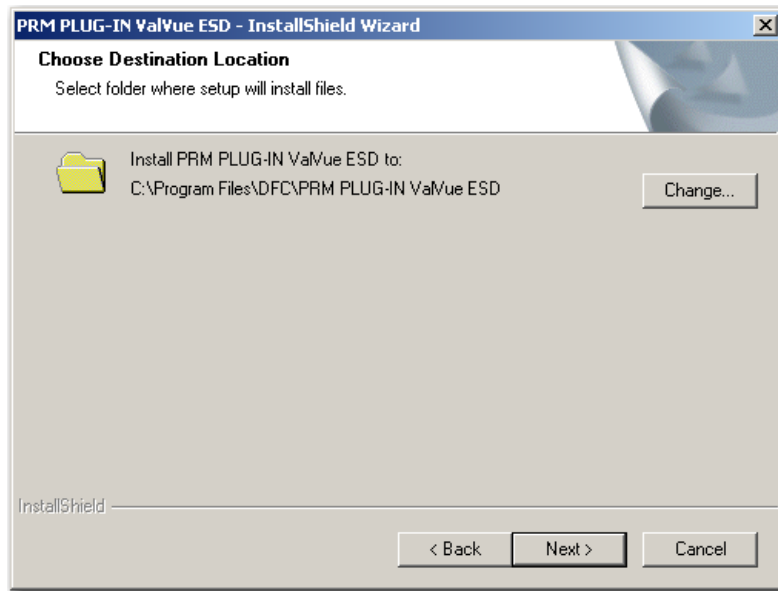

Figure 24 PRM Plug-In Destination Folder

7. Click **Change** and the *Choose Folder* dialog appears (Figure 25).

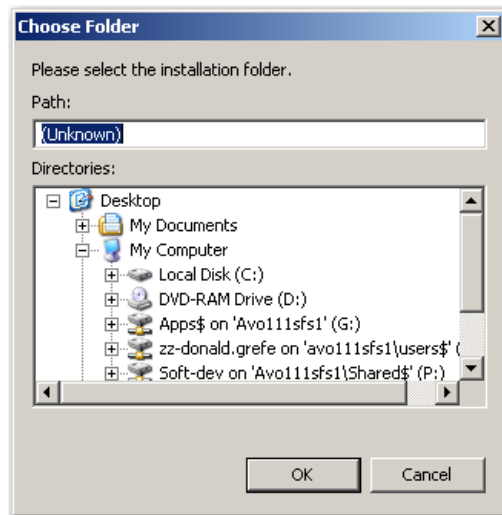

Figure 25 Choose Folder

- Navigate to the desired folder, click **OK** and **Next** and the screen appears (Figure 26).

**CAUTION**



*Use the same folder as with the ValVue ESD DATABASE. The installer also creates a data source for the database. If the database already exists, the installer updates the tables as necessary. No existing data is lost.*

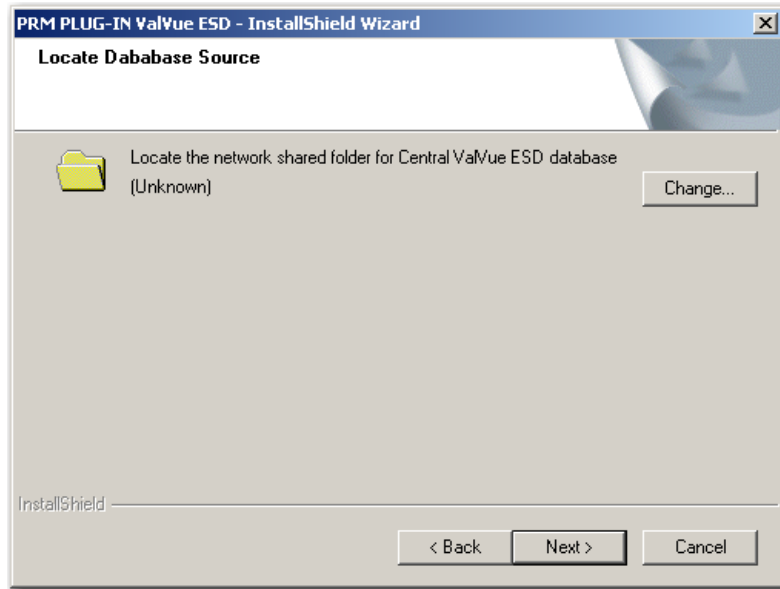

**Figure 26 PRM Plug-In Client Database Location Destination Folder**

- Click **Change** and the *Choose Folder* dialog appears (Figure 27).

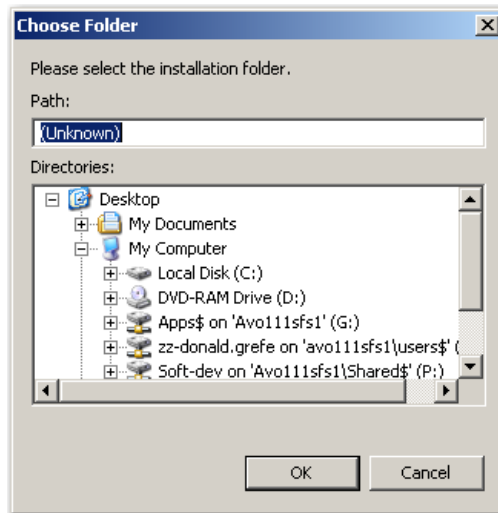

**Figure 27 Choose Folder**

10. Navigate to the desired folder, click **OK** and **Next** and the screen appears (Figure 28).

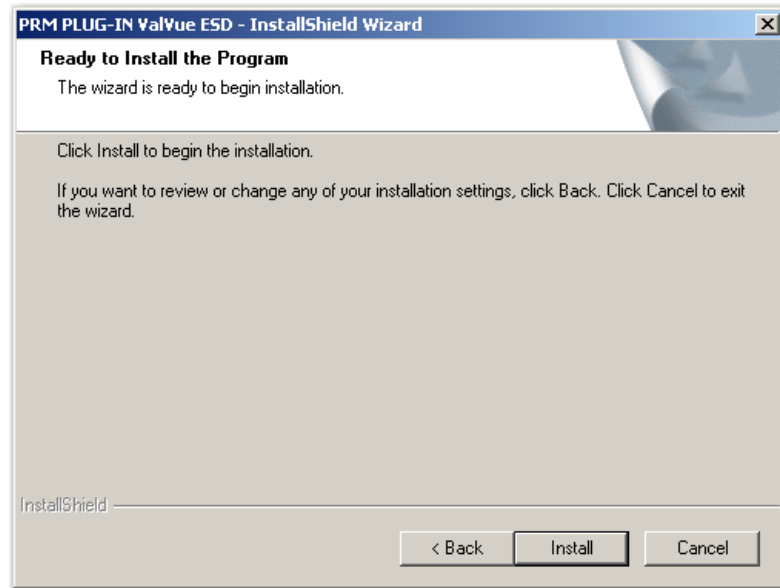

**Figure 28 Ready to Install**

11. Click **Install** and the *Setup Status* screen appears followed by *InstallShield Wizard Complete*.
12. Click **Finish**.

### **PRM PLUG-IN ValVue ESD Warning**

Listed below are warnings pertaining to the installation of the PRM PLUG-IN ValVue ESD.

#### ***PRM Multi-Server***

Because of the connection with the database and Central ValVue ESD, the Multi-Server switching feature, available on the PRM client, is not allowed.

#### ***PRM PLUG-IN ValVue ESD Installation Folder***

As mentioned in installation instructions, the PlugInValVue ESD application must be installed to the same drive and folder on every machine



## Registering ValVue ESD

When you start ValVue ESD for the first time the registration window launches. ValVue ESD software must be registered to activate the permanent installation. ValVue ESD can be used without registration for 60 days. Registration allows the factory to keep track of all of ValVue ESD users so that we can notify you of any changes or important information about new software features and updates. A registration card is included with the installation CD.

The software package contains a serial number. Keep a record of the serial number in a secure location. Do not discard the registration card. To register your software, you must launch the ValVue to obtain an installation ID number, then contact the factory by mail, telephone, email or Fax, and provide your name, company's name, contact information, the CD-ROM serial number, and the installation ID number from the ValVue ESD login display. Factory contact information is provided on the registration card that is part of the software package.

Your serial number is located on the ValVue ESD package and on the enclosed sticker. Place the serial number sticker on the detachable card included with the Registration Instruction card and store the card in a secure location. You need the serial number to move ValVue ESD to a different computer.

Masoneilan Software Registration Center provides you with software keys that you enter the next time you run the program. Contact the factory for a new software key if you are moving ValVue ESD to a different computer or, if you do not have a serial number.

To register ValVue ESD:

1. Start ValVue ESD either by clicking on the desktop icon or using the Start programs selection. When you start ValVue ESD, the registration window appears (Figure 29).

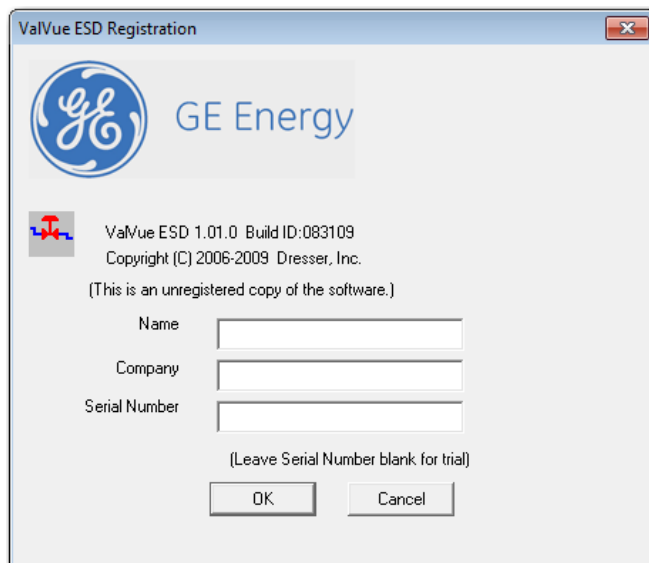

Figure 29 Owner and Product Key Registration Window

2. Enter *Name*, *Company* and *Serial Number* in the registration and click **OK**.



**Figure 30 Applying Owner and Product Key Information**

The software key registration window appears (Figure 31).

3. Click **Mux** and enter a software key for the Mux option, if applicable.

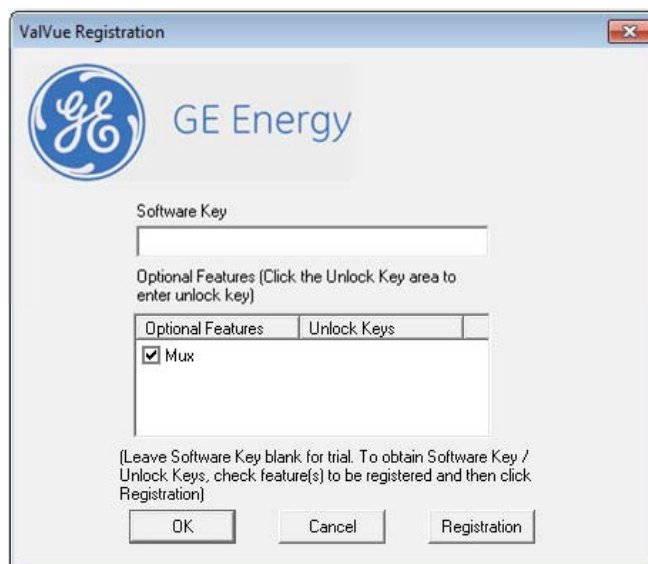

**Figure 31 Software and Mux Key Window**

4. Click **Registration** (Figure 32).



**Figure 32** Launching Registration Window

5. Enter your name and the name of your company. You are now ready to contact the factory with this information, to obtain your software keys. There are four methods shown on the Registration Instruction Card:

- Mail
- Phone
- Fax
- Email

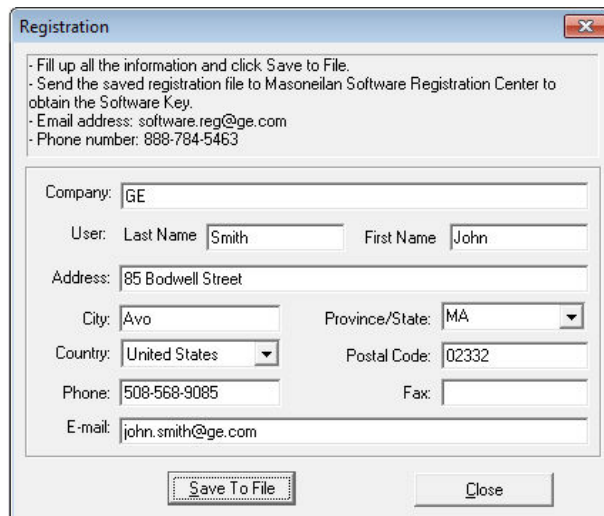

**Figure 33** Registration Window

6. Click **Save to File** to save your registration file. A Windows browser appears (Figure 34).
7. Navigate to the desired folder, name the registration information (.txt) file and click **Save**.

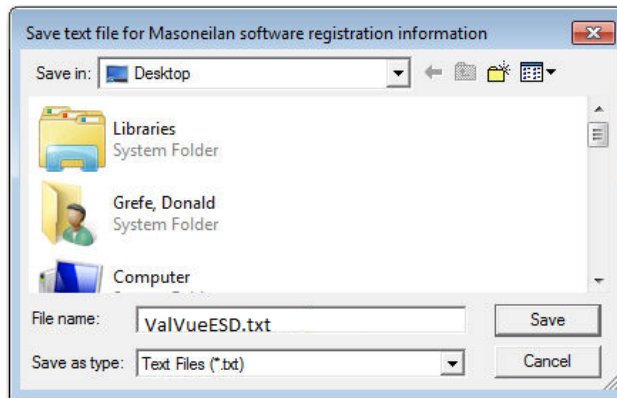

**Figure 34 Save Registration Information**

A dialog appears (Figure 35).

8. Email the registration information by clicking **Yes**.

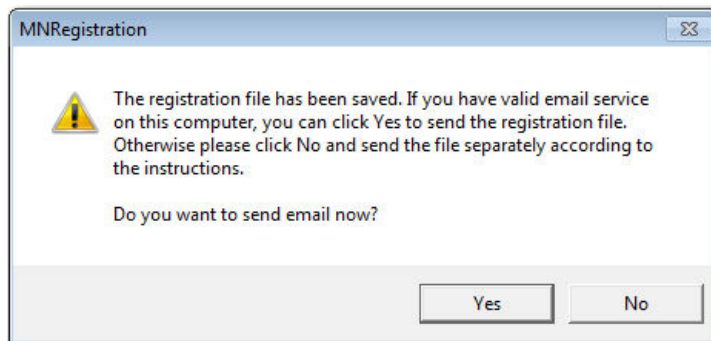

**Figure 35 Registration File Saved Dialog**

ValVue ESD launches your email service and automatically attaches the registration and Masoneilan's Software Registration Center.

9. Click **Send** to email the registration.

If your email program fails to start, contact the software registration center using the email address, phone number, address, or fax number given on the registration card (contained with the ValVue ESD cd).

A dialog indicating the email has been sent appears (Figure 36).

10. Click **OK** to close the dialog.

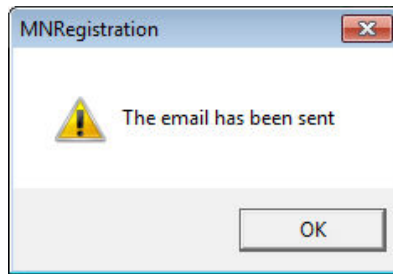

**Figure 36 Registration Email Sent Dialog**

### Entering Software Keys

After you have sent the registration info, you are provided with software keys for ValVue ESD and optional features (when applicable).

Once you have your key, to enable the program:

1. Start ValVue ESD.
2. Choose **Help > View Registration**.
3. Enter the *Product Key* (if not already entered).
4. Click **OK**. On the 2nd registration screen, enter the software key returned by the factory (Figure 37).

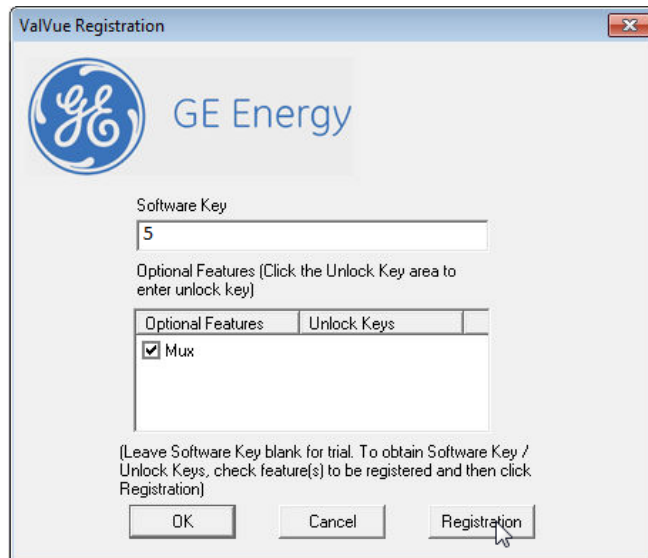

**Figure 37 Entering Software Key**

5. Enter the software key, if applicable, by clicking on the screen under the *Unlock Keys* field and the field becomes active. Enter the *Mux software key*.

6. Click **OK**.



**Figure 38 Entering Mux Unlock Key**

When the registration is complete and successful the message shown in Figure 39 appears.

7. Click **OK**.



**Figure 39 Successful Registration Message**

## How Do I?

This section directs you to various sections of the online help and pdf version of the help () to configure, operate and use the tools available in the ESDVue software.

### ***What You Can Do on the Monitor Screen***

See the *Monitor* section. Here you can:

- Monitor the current operation of the SVI II ESD.
- Change operation parameters.
- Monitor the current PST controller Characteristics.
- Adjust the PST controller Indicator (graphical representation)
- Perform the following operations from the right-click menu:
  - Move the valve to full Open, Full Close or Set to Fail Position.
  - Generate reports on SVI II ESD operation.
  - Reset the device.
  - Save, restore data.
  - View all parameters.
  - Backup the NVM

### ***What You Can Do on the Trend Screen***

See the *Trend* section. Here you can:

- View, detach and operate the *Trend* window.

### ***What You Can Do on the Configure Screen***

See the *Configure* section. Here you can:

- Set the information, in the Setup mode, that tells the SVI II ESD how the valve/actuator is configured by adjusting the following parameters:
  - Tag Information*
  - Fault Settings*
  - Language*
  - Air Action*
  - Button Lock*
  - PST Allow Options*
  - Pressure Units*
- Set up the Inputs and Outputs with *Configure I/O* window (refer to *Configure I/O* section)
- Quickly commission the SVI II ESD by launching *Setup Wizard* window.

### ***What You Can Do on the Diagnostics Screen***

See the *Diagnostics* section. Here you can, in the *Setup* mode:

- Perform Step Diagnostics and Extended Signature Diagnostics, including loading curves for comparison.
- Load and export data.

### ***What You Can Do on the PST Screen***

See the *PST* section. Here you can:

- Schedule Partial Stroke Testing (PST).
- Configure PST Settings.
- Run PST Diagnostics and View Results.
- Load and export data.

### ***What You Can Do on the Status Screen***

See the *Status* section. Here you can:

- See the operating and internal status of the SVI II ESD on a screen divided into a series of tabs that provide status, alarm, and fault information in a graphical form. Each alarm condition is color coded according to the alarm criticality.
- Reset the Current Faults or All Faults (Current and Historical). You can also select and clear an individual fault.
- See the Active Faults tab for current active faults.

### ***What You Can Do on the Check Screen***

See the *Check* section. Here you can:

- Monitor and adjust some of the basic parameters to do troubleshooting. You can:
- Send a HART command and view the result.
- Use the right-click menu or the *Tools* menu, in *Setup* mode, to set the SVI II ESD to *Full Open*, *Full Closed* and *Detach Trend*.

### ***How You Can Perform and Advanced Setup***

See the *Advanced Setup With ESDVue* section for instructions beyond the *Setup Wizard*.



# 4. Installation and Setup

## Overview

Figure 40 shows the SVI II ESD positioner which is designed to prevent and mitigate possibly negative situations. It is a position controller assembled on a pneumatically actuated valve assembly. Its role is to position an emergency shutdown valve to 0% or 100% with a probability of failure on demand (PFD) in accordance with IEC61508 for SIL3 application. It replaces solenoid valves typically utilized to actuate a spring-return. This section provides detailed procedures for installing the SVI II ESD.

### NOTE



*Prior to beginning the installation process review the "Safety Information" on page 17.*

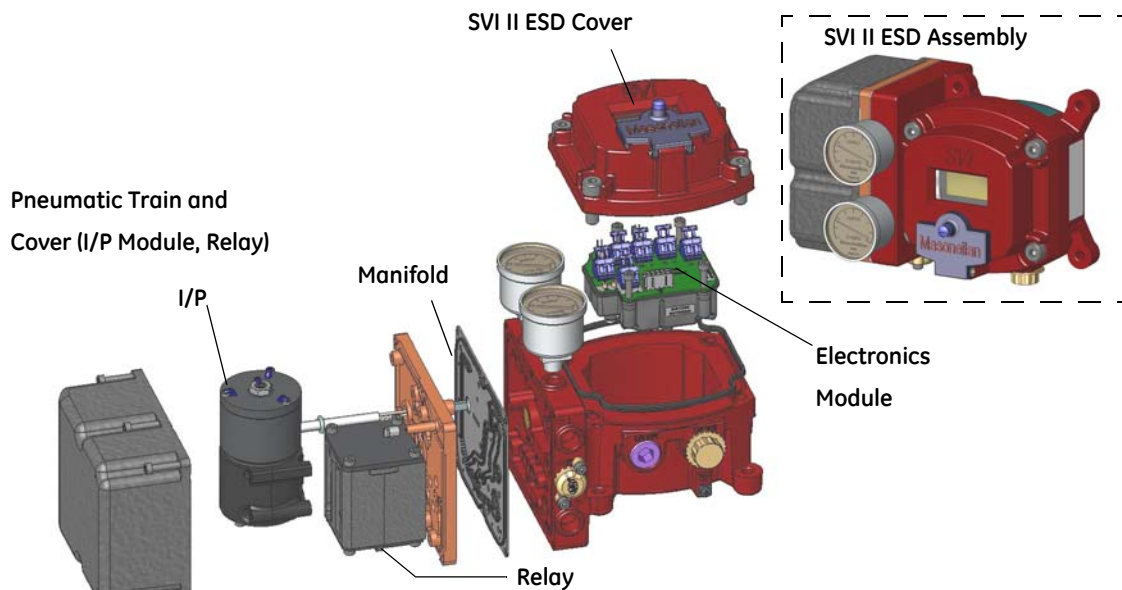

**Figure 40 SVI II ESD Exploded View**



# Pre-Installation Issues

## Storage

If the SVI II ESD is stored for a long period of time, you must keep the housing sealed against weather, fluids, particles, and insects. To prevent damage to the SVI II ESD:

- Use the plugs provided with shipment to plug the ¼ NPT air connections, on the positioner and on the air filter regulator set.
- Do not allow standing water to accumulate in packaging.
- Observe storage temperature requirements.

## Unpacking

Exercise care when unpacking the control valve and its mounted accessories. The SVI II ESD package contains a CD-ROM with ValVue ESD software and manuals.

**WARNING**



*Failure to adhere to the requirements listed in this manual can cause loss of life and property. Before installing, using, or carrying out any maintenance tasks associated with this instrument, **READ THE INSTRUCTIONS CAREFULLY.***

# Installation

Compliance voltage testing is best done before installation. See “Determining an SVI Positioner Compliance Voltage in a Control System” on page 219.

The steps necessary to complete the SVI II ESD installation and software setup are outlined in Table 4.

**Table 4 SVI II ESD Installation Steps**

Step No.	Procedure	Reference
1	Attach mounting bracket to the actuator.	See page page 63 for rotary valve and page 68 for reciprocating valve instructions.
2	Install the SVI II ESD magnetic assembly (rotary valves only).	See page 63 for instructions.
3	Assemble the SVI II ESD on the bracket that is mounted to the valve actuator.	See page 63 for rotary valve and page 68 for reciprocating valve instructions.
4	Connect the pneumatic tubing to the SVI II ESD.	See page 73 for instructions.
5	Connect the air supply to the SVI II ESD.	See page 75 for instructions.
6	Install the wiring for the SVI II ESD.	See page 75 for instructions.

**Table 4 SVI II ESD Installation Steps (Continued)**

Step No.	Procedure	Reference
7	Connect the PST controller to the HART <sup>®</sup> Control Loop segment by installing the SVI II ESD wiring.	See page 78 for instructions.
8	Power up the SVI II ESD.	See page 80 for instructions.
9	Configure/calibrate using ValVue ESD	See "Configuration" on page 90.

**WARNING**



*Failure to adhere to this manual's requirements can cause loss of life and property. Before installing, using, or doing maintenance tasks associated with this instrument, READ THE INSTRUCTIONS CAREFULLY.*

**Physical Location and Placement Guidelines**

When determining the location of the SVI II ESD adhere to the following guidelines:

- Allow sufficient room for cabling and pneumatic connections and for manual proof testing.
- Keep pneumatic piping to the actuator as short and straight as possible to minimize the airflow restrictions and potential clogging of the line. Long or kinked pneumatic tubes can also increase the valve closure time.
- Keep the Breather/Vent port accessible and for inspection for obstruction during manual proof testing.
- Mount the SVI II ESD in a mild vibration environment. If excessive vibration can be expected, take special precautions to ensure the integrity of electrical and pneumatic connectors or reduce the vibration using appropriate damping mounts.

**Necessary Precautions**

To avoid injury or affecting the process when installing or replacing a PST controller on a control valve, ensure that:

1. If the valve is located in a hazardous area make sure the area has been certified as *safe* or that all electrical power to the area has been disconnected before removing any covers or disconnecting any leads.
2. Shut off air supply to the actuator and to any valve mounted equipment.
3. Ensure the valve is isolated from the process by either shutting off the process or using bypass valves for isolation. Tag shutoff or bypass valves to guard against a *turn-on* while work is in progress.
4. Bleed air from actuator and check that valve is in its de-energized position.

It is now safe to disconnect and remove any valve mounted equipment that is being replaced.

## Natural Gas Supply Considerations

If the pneumatic system is connected to natural gas, the pneumatic control system constantly bleeds a small amount of the natural gas into the area around the SVI II ESD. Also, during a vent cycle (actuator pressure relief), natural gas from the actuator is released into the area around the SVI vent port. Consider both sources of natural gas when evaluating the Hazardous Classification for the area.

Remote piping of the actuator venting is possible to reduce the amount of natural gas released into the area around the SVI II ESD. Installing remote actuator vent gas piping does not capture all gas emitted. A small amount of natural gas still bleeds constantly in the area around the SVI II ESD. Consider the bleeding and releasing of natural gas when evaluating the Hazardous Clarification for the area.

Refer to "Installing an SVI II ESD in a Natural Gas Environment" on page 173 for installation instructions.

### NOTE



*Area classification is the responsibility of the end user.*

### WARNING



*Do not remove the instrument cover or connect to an electrical circuit unless the power is disconnected. Natural gas will escape into the surrounding atmosphere upon disconnecting any of the pneumatic connections or removing any cover or pressure containing component.*

### WARNING



*EXPLOSION HAZARD - DO NOT DISCONNECT EQUIPMENT OR REMOVE COVER UNLESS POWER HAS BEEN DE-ENERGIZED OR THE AREA IS KNOWN TO BE NON-HAZARDOUS. Natural Gas may be contained within the SVI II ESD. Even after disconnecting the SVI II ESD from all the pneumatic connections Natural Gas may still be present within the SVI II ESD.*

### WARNING



*EXPLOSION HAZARD - NATURAL GAS MAY ESCAPE FROM THE SVI II ESD UPON REMOVAL OF ANY COVER OR COMPONENT. Ensure the cover is correctly installed before putting this unit into service.*

### WARNING



*EXPLOSION HAZARD - AN IMPROPERLY INSTALLED COVER COULD LEAK NATURAL GAS INTO THE AREA. The interior of the SVI II ESD is positively pressure with supply medium. Appropriate safety measures must be taken to handle pressurized natural gas that may enter the electrical conduit or cable system.*

**WARNING**



*EXPLOSION HAZARD - A MISSING OR IMPROPERLY INSTALLED CONDUIT SEAL, CABLE SEAL, OR CABLE GLAND COULD LEAK NATURAL GAS INTO THE CONDUIT/CABLE SYSTEM, AND/OR INTO ANY AREA WHERE THE CONDUIT/CABLING SYSTEM IS PRESENT OR CONNECTED TO.*

**WARNING**



*Natural gas will constantly bleed and possibly vent from the SVI II ESD if connected to a natural gas supply. Hazardous area clarification is the responsibility of the end user. Area ventilation and other safety measures may be required to maintain a safe environment.*

**WARNING**



*Installation in poorly ventilated confined areas, with any potential of gases other than oxygen being present, can lead to a risk of personnel asphyxiation.*

**WARNING**



*Isolate the valve from the process and disconnect air tubing from the positioner. Disconnect air fully to avoid injury or process damage.*

## Mounting the SVI II ESD on Rotary Valves

This section describes the procedure for mounting the SVI II ESD on rotary control valves that have less than 60° rotation, such as a Camflex\* or a Varimax\*. Figure 42 shows a side view of a Camflex actuator and the SVI II ESD actuator mounting brackets.

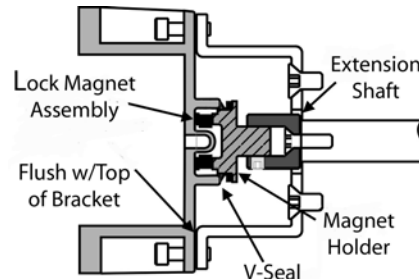

Figure 42 Camflex with Mounting Bracket (Side View)

### Mounting the SVI II ESD on a Rotary Actuator

Tools required:

- 3/16" Hex Key
- 5/32" Hex Key
- 3 mm, 4 mm, 5 mm Hex Key
- 7/16" Wrench

To mount the SVI II ESD:

1. Attach the SVI II ESD rotary mounting bracket to the valve actuator using two (2) 5/16 - 18 UNC flat-head cap screws. In the preferred mounting position, the long end of the mounting bracket is on your left when facing the actuator, for any position of the valve and actuator.
2. Bolt the extension shaft to the valve position take-off shaft using a 1/4 - 28 UNF socket flathead screw. Secure the machine screw holding the extension shaft with a torque of 144 in-lbs (16.269 N-m).
3. On internal valve pressure the thrust shaft is pushed out to the mechanical stops, usually a thrust bearing. On valves where the valve position take-off is mounted directly on the end of the plug shaft, a Camflex for example, the shaft must be bearing on its stop to properly set up the SVI II ESD PST controller. During hydrostatic testing the shaft is thrust to its stop and a normally tightened packing retains it in that position.
4. On vacuum service, the valve shaft may be drawn into the body by the vacuum acting on the shaft, but the magnetic coupling must be assembled flush with the mounting bracket with the shaft pulled fully out to its thrust bearing. Check that the endplay from the vacuum position to the fully extended position is less than 0.06 in. (1.524 mm)





5. Slide the magnet holder into the extension shaft. The location of the magnets is in the ring of the magnet holder. The magnetic axis is the imaginary line through the center of both magnets.
6. Rotate the magnet holder so that the magnet axis is vertical when the valve is in the closed position.
7. Align the end of the magnet holder flush with the end of the mounting bracket. Secure the magnet holder with two M6 set screws.
8. Slide the V-Seal over the magnet holder.
9. Secure the SVI II ESD onto the mounting bracket using four M6 x 20 mm Socket Head Cap Screws.
10. Ensure no interference exists with the position sensor protrusion.
11. Ensure that the V-Seal makes contact with the skirt around the position sensor protrusion on SVI II ESD housing.



## Travel Sensor Alignment

Table 5 shows the general guidelines for travel sensor alignment. Review the table prior to installing the SVI II ESD on a rotary valve actuator for proper alignment of the magnet.

**Table 5 Travel Sensor Alignment**

Rotary Mounting System	Stroke Direction	Magnet Orientation	Valve Position	Sensor Counts
Rotary	<60° Rotation Clockwise or counter-clockwise rotation	 (0°)	Closed (0%)	0 +/- 1000
	>60° Rotation Clockwise with increasing setpoint	 (-45°)	Full Open or Full Closed	-8000 +/- 1500 or +8000 +/- 1500
	>60° Rotation Counter Clockwise rotation with increasing setpoint	 (+45°)	Full Open or Full Closed	-8000 +/- 1500 or +8000 +/- 1500
General Rule for other configurations	Any amount of rotation Clockwise or counter-clockwise	 (0°)	50% Travel (Mid-Stroke)	0 +/- 1000

### Dismantling the SVI II ESD from Rotary Valves

**WARNING**



*Before carrying out any work on the device, power off the instrument or ensure that the device's location conditions for potentially explosive atmosphere permit the safe opening of the cover.*

To remove the SVI II ESD PST controller from a rotary valve perform Steps 1 - 9 on page 63 in reverse.

## Mounting the SVI II ESD with NAMUR Kits

There are two versions of this kit:

- 20 and 30 mm
- 50 mm

### 20 and 30 mm Mounting

Tools required:

- 3 mm hex key
- 4 mm hex key

Refer to Figure 43 for this procedure.

To mount using this kit:

1. Attach the mounting bracket to the valve actuator using four (4) M5 x 0.8 x 10 flat-head cap screws.

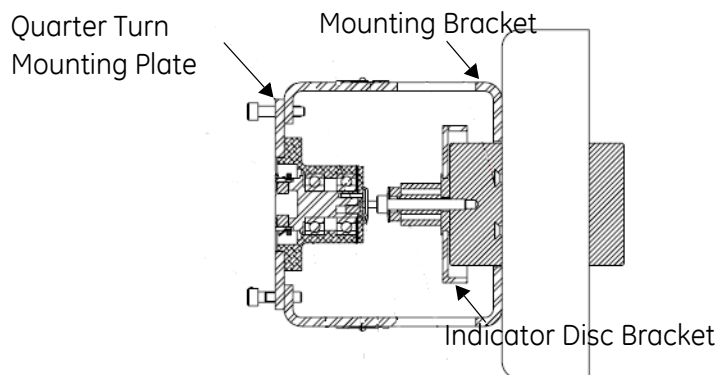

**Figure 43 Namur 20/30 mm Mounting Kit**

2. Place the indicator disk with metal insert over the valve actuator shaft and secure using an M6 x 1.0 x 45 socket-head screw.
3. Place the Quarter Turn Mounting Plate into place sliding it through the anti-backlash spring into the dowel pin at the end of the plate into the hex head screw installed in step 2.
4. Secure the plate to the bracket using four (4) flat head cap screws.

## 50 mm Mounting

Tools required:

- 3 mm hex key
- 4 mm hex key

Refer to Figure 44 for this procedure.

To mount using this kit:

1. Attach the mounting bracket to the valve actuator using four (4) M5 x 0.8 x 10 flat-head cap screws.
2. Place the indicator disk with metal insert over the valve actuator shaft.

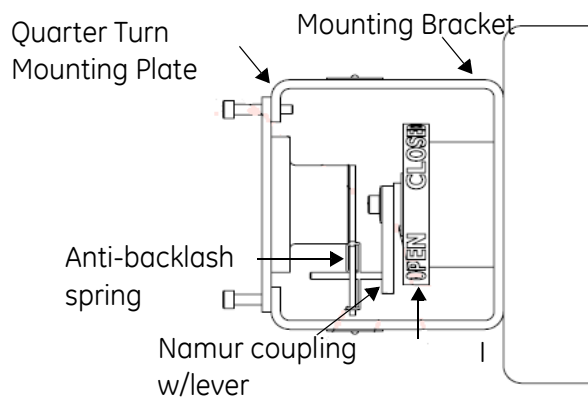

**Figure 44 Namur 50 mm Mounting Kit**

3. Place the Namur coupling and lever on top of the indicator disc and secure with an M6 x 1.0 x 25 socket-head screw.
4. Place the Quarter Turn Mounting Plate into place sliding it over the lever and through the anti-backlash spring.
5. Secure the bracket using four (4) flat head cap screws.

## Mounting the SVI II ESD on Reciprocating Valves

The process of mounting the SVI II ESD on a reciprocating valve consists of mounting the unit on the actuator that is attached to the valve. This section describes the procedure for mounting the SVI II ESD on Reciprocating Valves (using Masoneilan's 87/88 Multi-Spring actuators as an example).

## Mounting the SVI II ESD on a Reciprocating Actuator

Tools required:

- 7/16" Combination Wrench (2 required)
  - 3/8" Combination Wrench
  - 1/2" Combination Wrench
  - Phillips Head Screw Driver
  - 5 mm Hex Key Wrench
1. Ensure that the lever is pinned to the magnet assembly and held securely by an M5 flat head screw to ensure that the magnet axis is vertical when the lever is in the valve closed position. Tighten the lever screw securely. Refer to Figure 45.

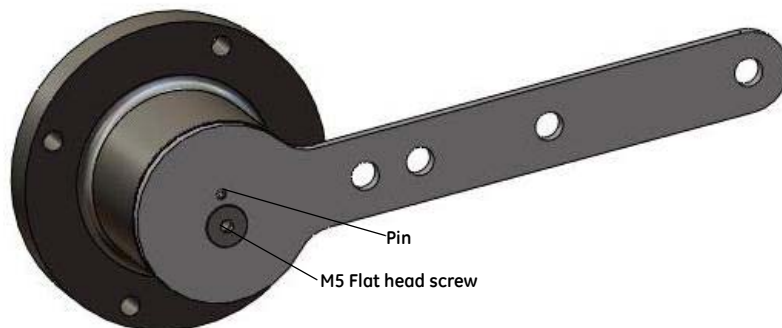

**Figure 45 Magnet Holder for Reciprocating Valves**

2. Mount the SVI II ESD reciprocating mounting bracket to the actuator using two (2) 5/16 - 18 UNC cap screws. The mounting location of the bracket depends on the size and stroke of the actuator. Refer to Figure 46 and Figure 6 on page 70.

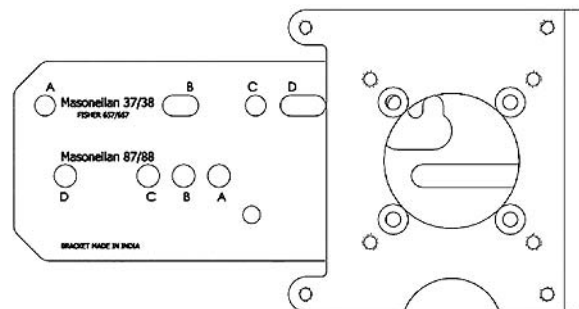

**Figure 46 Reciprocating Valve Mounting Bracket**

3. Select mounting hole A, B, C or D for the stroke of the valve. For example, hole B is shown in Figure 46 on page 68 for a size 10 actuator with 1.0" stroke. Unless otherwise specified, the SVI II ESD mounting assumes that the actuator is in the normal upright position. The mounting hole in the slotted opening of the mounting bracket must be left when facing the actuator, with the actuator in the upright position.
4. Thread the take-off rod to the actuator stem connector. Refer to Figure 47. Ensure that the travel pointer located on the coupling is correctly positioned.
5. Attach the right hand threaded rod end to the SVI II ESD lever using a 1/4 - 20 x 1" cap screw and nut as shown. The lever hole position to be used depends upon the specific valve stroke. Refer to Figure 47 on page 69 and the Reciprocating Valve Linkage Selection, Table 6 on page 70.
6. Thread the right hand lock nut and turnbuckle onto the right hand rod end approximately two turns. Turnbuckle length is a function of actuator size. (Refer to Table 6 on page 70.)
7. Secure the magnet housing assembly, including the lever and right hand rod end, to the bracket using four M5 X 10 mm flat head screws.
8. Attach the left hand threaded rod end to the take-off rod with 1/4 - 20 UNC nut and thread the left hand lock nut onto the rod end.

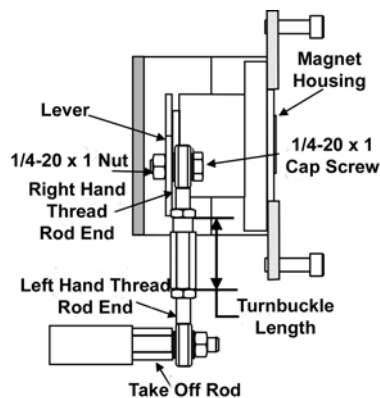

**Figure 47 Reciprocating Linkage**

9. Move the valve to its closed position. For air to extend, this requires using air pressure in the actuator to fully stroke the actuator. For air to retract, actuators vent the actuator of air pressure.
10. Thread the turnbuckle onto the left hand threaded rod end. Refer to Figure 47.
11. Adjust the turnbuckle until the hole in the SVI II ESD lever is aligned with the indicating hole in the bracket. Tighten both turnbuckle lock nuts. Refer to Figure 47.
12. For reciprocating valves the adjustable link turnbuckle must be parallel to the valve stem. To ensure linearity in positioning, verify that the hole in the lever aligns with the indicating hole in the bracket when the valve is in the closed position. Check that the bracket is mounted using the proper holes. (Refer Table 6 on page 70.).
13. Mount the SVI II ESD to the bracket and secure with four M6 socket head cap screws.

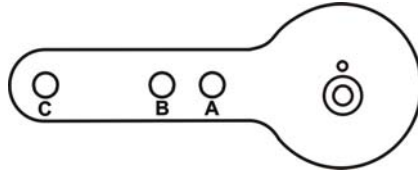

Figure 48 Lever for Model 87/88 Multispring Actuator

Table 6 Reciprocating Valve Mounting Hole and Turnbuckle Length

Actuator Size Masoneilan	Stroke	Mounting Hole	Lever Hole	Turnbuckle Length
6 and 10	0.5 - 0.8" (12.7 - 20.32 mm)	A	A	1.25" (31.75 mm)
10	0.5 - 0.8" (12.7 - 20.32 mm)	A	A	1.25" (31.75 mm)
10	>0.8 - 1.5" (20.32 - 41.5 mm)	B	B	1.25" (31.75 mm)
16	0.5 - 0.8" (12.7 - 20.32 mm)	B	A	2.90" (73.66 mm)
16	>0.8 - 1.5" (20.32 - 41.5 mm)	C	B	2.90" (73.66 mm)
16	>1.5 - 2.5" (41.5 - 63.5 mm)	D	C	2.90" (73.66 mm)
23	0.5 - 0.8" (12.7 - 20.32 mm)	B	A	5.25" (133.35 mm)
23	>0.8 - 1.5" (20.32 - 41.5 mm)	C	B	5.25" (133.35 mm)
23	>1.5 - 2.5" (41.5 - 63.5 mm)	D	C	5.25" (133.35 mm)

## Dismantling the SVI II ESD from Reciprocating Valves

### WARNING



*Before carrying out any work on the device, power off the instrument or ensure that the local conditions for potentially explosive atmosphere permit the safe opening of the cover.*

To remove the SVI II ESD PST controller from a reciprocating valve perform Steps 1 - 12 in the reverse order.

## Checking the Magnet

There are two methods of checking the SVI II ESD magnet:

- Perform a visual inspection
- Use ValVue ESD to check the magnet

## Performing a Visual Inspection

To perform a visual inspection refer to Table 5 on page 65 and ensure that the magnet is correctly oriented for the actuator/valve configuration.

## Using ValVue ESD to Check Magnet Position

Use this procedure to check the magnet using ValVue ESD (provided with SVI II ESD). Also refer to Table 5 on page 65 for sensor information.

1. Connect to the PST controller in accordance with the ValVue ESD instructions. For further information refer to the ValVue ESD On Line Help or Instruction Manual.
2. After the PST controller has been installed and set up with a HART<sup>®</sup> Modem in a HART<sup>®</sup> compliant communications loop, install ValVue ESD on the computer that is connected to the HART<sup>®</sup> modem.
3. Run ValVue ESD.
4. Select the installed ESD PST controller from the list of *Connected Devices* as shown in Figure 49 and click **Connect**.
5. Select the: **Check** tab to view the current operating conditions of the selected PST controller.
6. Read Raw Position Data on the Check screen as shown in Figure 49.
7. The Raw Position Sensor value measured must in accordance with the Table 5 on page 65.

### ValVue ESD Connected Devices Screen

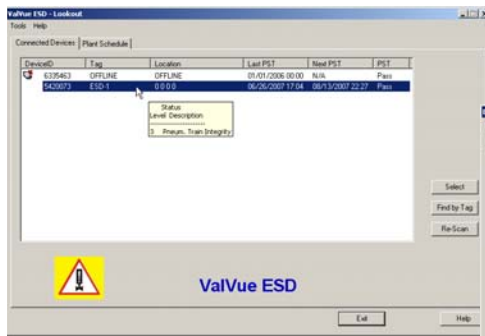

### ValVue ESD Check Screen

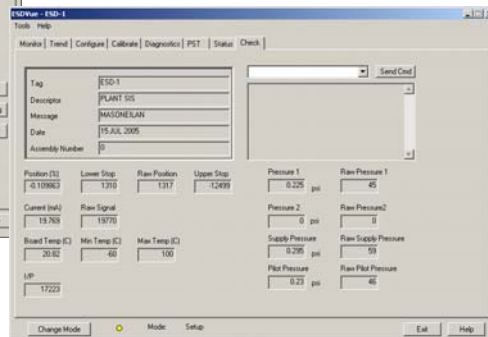

Figure 49 ValVue ESD for Checking Magnet Position

## Checking Actuator, Linkages, or Rotary Adapter

Verify that the mounting has not been damaged in shipment for a pre-mounted SVI II ESD, physically inspect the actuator, linkage. Record the following information for the configuration checkout:

- Valve Air to Open (ATO) or Air to Close (ATC)
- Actuator pressure rating
- Actuator bench range
- Inherent trim characteristic of the control valve; linear, equal percentage, or other.



*For the aforementioned information, refer to the valve data sheet or model number of control valve.*

## Verify Mounting and Linkage Adjustment

Inspect the mounting and make any needed adjustments before running the PST controller and checking the digital configuration.



## Connecting the Tubing and Air Supply

**NOTE**



*It is advisable to tube and apply the air supply to the SVI II ESD before connecting the electrical input signal to power it up.*

**NOTE**



*For small actuators it may be necessary to use 1/8" tubing for Autotune to work properly.*

This section describes the process for connecting the tubing and air supply to a single acting PST controller.

### Pneumatic Connections

The SVI II ESD is intended for use with industrial compressed air or natural gas systems only that meet the requirements of ISA standard 7.3. Supply pressure must not exceed 120 psi. A coalescing filter can be used to assure that the supply air is sufficiently free of oil, water, and particulate contaminants. Ensure that an adequate pressure relief provision is installed when the application of system supply pressure could cause peripheral equipment to malfunction. Installation must be in accordance with local and national compressed air and instrumentation codes. Table 7 provides the pneumatic connections and air supply requirements for the SVI II ESD.

**Table 7 Pneumatic Connections/Air Supply Requirements**

Recommended Piping Inlet/Outlet	1/2" stainless steel or PVC tubing. The length of tubing between the SVI II ESD and the valve shall be kept as short as possible and free of kinks
Instrument Air Pressure	30 - 120 psi (2.07 - 8.27 bar) (207 - 827 kPa)
Dew Point	At least 18° F (-8° C) below minimum anticipated ambient temperature
Particulate Matter	Filtered to 5 microns
Oil Content	Less than 1 ppm w/w
Contaminants	Free of all corrosive contaminants

## Single Acting PST Controller

### WARNING



Isolate the valve from the process and disconnect air tubing from the PST controller. Disconnect air fully to avoid injury or process damage.

The supply and output connections for the SVI II ESD, located on bottom of the pneumatic block, are 1/4" NPT threaded. Output is toward the front, supply is toward the back.

Maximum allowable air supply pressure to the SVI II ESD varies according to actuator, valve size, and valve type. Refer to the serial plate of the valve to know the specified supply pressure; it must never be less than the maximum spring pressure +10 psi.

1. Install the tubing to the air supply port (S←).
2. For a single acting actuator - pipe the outbound air from the output pressure port (←O) to the actuator.
3. Air supply:
  - Supply pressure for single acting SVI II ESD:  
30 -120 psi (2.07 - 8.28 bar) (207- 827.6 kPa)
  - Minimum tubing diameter 1/4" (6mmx4mm)



Figure 50 Air Ports on Single Acting PST Controller

## Checking the Air Supply

Use this procedure to check the air supply.

1. Turn on the air supply.
2. Adjust the filter regulator.
3. Supply pressure must be a minimum of 10 psi greater than the spring range of the actuator but can not exceed the rated actuator pressure. Refer to the valve or actuator instruction manual.
4. Inspect the tubing connections between the filter-regulator and the PST controller for leaks.
5. Verify that the tubing is not bent or crushed.
6. Verify that all fittings are leak tight.

### NOTE



*Do not use Teflon pipe seal tape. The Teflon tape can shred into particles that are harmful to the pneumatic components.*

For detailed information on pneumatic connections refer to “Pneumatic Connections” on page 73.

## Wiring the SVI II ESD

There are two components to wiring the SVI II ESD; making an electrical connection for power and making a local control loop connection for HART<sup>®</sup> communication.

### Electrical Connection Guidelines

When making the SVI II ESD electrical connections, follow these guidelines:

1. The SVI II ESD device is available in two control signal configurations: 4-20 mA or 0/24 VDC.
2. Provide sufficient electrical isolation between adjacent signal lines and between signal lines and ground for all wiring.
3. Use stranded 14 to 22 AWG (or equivalent gauge and flexibility).
4. Use conduit sealant to prevent condensation from entering the enclosure and, in Class 1 Div. 2 conditions to prevent hazardous gases and vapors from migrating through the conduit to the control room or an open ignition source.
5. Wire according to the National Electrical Code (ANSI-NFPA 70) or other applicable local codes.
6. The terminal clamps are designed for one wire only; DO NOT attempt to terminate multiple wires into one terminal.

7. Strip the wires to the recommended length (See product specifications).
8. Ensure all wire stands are fully inserted into the terminal block and no shorts between adjacent wires on the terminal block are possible.
9. Use care when running signal wiring near to or crossing conduit or wiring that supplies power to motors, solenoids, lighting, horns, bells, etc. Provide sufficient electrical isolation and shielding against electro-magnetic interference from items in the vicinity of the cable run.
10. Run AC power wiring in a separate conduit from DC power. All power wiring to and from the SVI II ESD should be in grounded conduit. Protect outdoor cable runs against lightning strike.
11. Connect the SVI II ESD to a high quality instrument grade ground sized as required by local electrical codes. A grounding stud is provided inside the enclosure.

**WARNING**



*Comply with current national and local regulations for electrical installation work. Comply with national and local explosive atmosphere regulations.*

*Before carrying out any work on the device, power off the instrument or make sure that the locale conditions for potentially explosive atmosphere permit the safe opening of the cover.*

**CAUTION**



*Refer to "Output Switches" on page 133 for guidelines on safely wiring switch load limits.*

## SVI II ESD Configurations

There are three possible SVI II ESD installation configurations each with a different wiring scheme.

- Analog Safety Demand (ASD)
- Discrete Safety Demand (DSD)
- Analog with Discrete Safety Demand (A/DSD)

### Analog Safety Demand (ASD)

The Analog Safety Demand configuration is: 4 - 20 mA signal, power and trip signal with superimposed HART<sup>®</sup> communications (Figure 51).

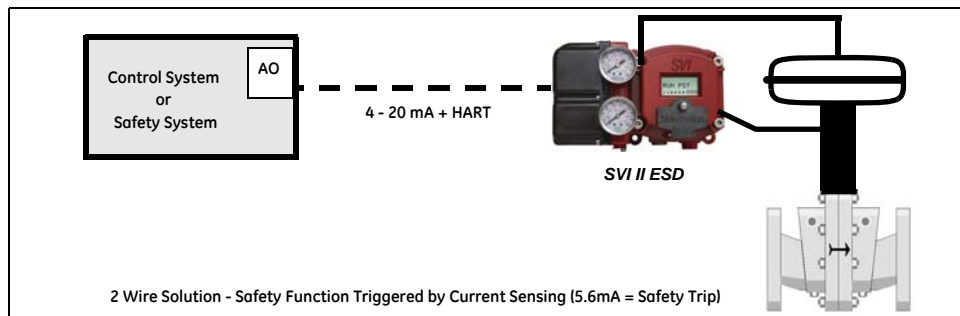

Figure 51 Analog Safety Demand (ASD) Configuration

### Discrete Safety Demand (DSD)

The Discrete Safety Demand configuration is: 24 VDC, power and trip signal with superimposed HART<sup>®</sup> communications (Figure 53).

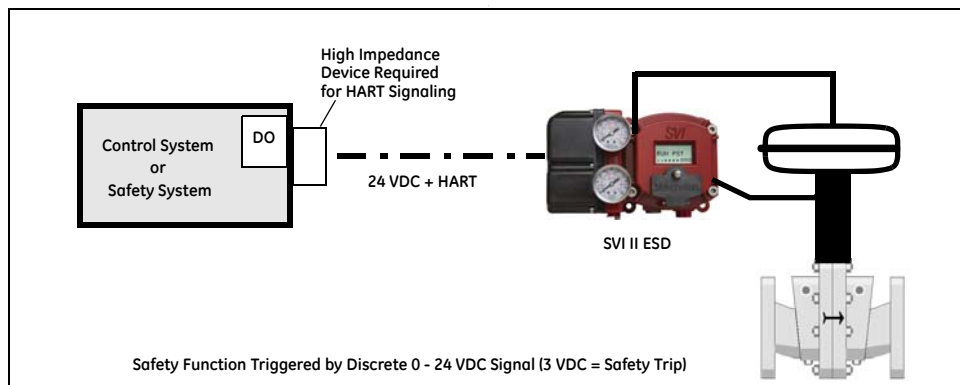

Figure 52 Discrete Safety Demand (DSD) Configuration

## Analog with Discrete Safety Demand (A/DSD)

The Analog with Discrete Demand configuration is: 4 - 20 mA power input with superimposed HART<sup>®</sup> communications for control system and 24 VDC 2 wire for Safety System (Figure 53).

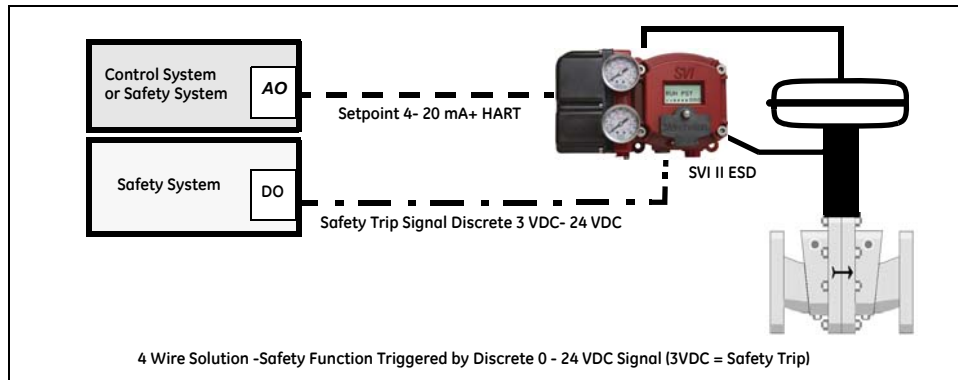

Figure 53 Analog with Discrete Safety Demand (A/DSD) Configuration

## HART<sup>®</sup> Wiring Guidelines

In order for the SVI II ESD to communicate, the SVI II ESD must be physically connected to a HART<sup>®</sup> compliant network. "Connecting to the Control Loop" outlines wiring the SVI II ESD.

### Connecting to the Control Loop

The SVI II ESD PST controller *MUST BE* grounded according to local regulations. It is important to maintain correct polarity at all times, otherwise the PST controller may not operate properly. Physically connect the SVI II ESD to the HART<sup>®</sup> loop using a cable specified by Field Comm<sup>®</sup>. A shielded cable is recommended.

To connect the Control Loop to the SVI II ESD:

1. Connect one end of the cable to the control loop's 4 - 20 mA output.
2. Remove the threaded wiring covers on the PST controller.
3. Connect the other end of the cable to the SVI II ESD. There are two threaded openings on the PST controller. Use the opening with the red plastic insert.
4. Maintain polarity + and - respectively.

#### NOTE



*Position Retransmit: when wiring this feature:*

*Wire using the same gauge wire as for the 4-20 mA control loop.*

*In general, ensure that it is connected to the control system's analog systems card.*

*Ensure the control loop is powered when using a meter to make any measurements.*

## Wiring a Position Retransmit

### CAUTION

*For proper operation, maintain signal polarity + and - respectively.*



To connect:

1. Strip approximately 1/4" (6.35 mm) of the insulation at the end of wires (wire size 14 to 28 AWG, 2.5 mm<sup>2</sup> to .08 mm<sup>2</sup>).
2. Connect the +/- terminals from the 4-20 mA Out to the position retransmit input signal: + to + and - to -. See Figure 54 on page 83, Figure 55 on page 84 or Figure 56 on page 84, depending on card type.

To troubleshoot retransmit connections:

- Ensure that the retransmit circuit has a minimum voltage of 10 V (maximum 30 V).
- Ensure the minimum AO current is 3.2 mA. If the module loses power and the AO circuit remains powered, the AO signal will be 3.2 mA.

## Compliance Voltage in Single Drop Current Mode

The SVI II ESD requires 9.6 V at 20 mA and 11.0 V at 4 mA. Typical HART<sup>®</sup> devices require MORE Voltage at higher current and MORE current source have LESS Voltage available at higher current. The SVI II ESD is unique in that it requires LESS Voltage at higher current which compliments the characteristic of the source requiring only 9.6 V at 20 mA. See "Determining an SVI Positioner Compliance Voltage in a Control System" on page 219.

### NOTE



*Improperly or inadequately grounded installations can cause noise or instability in the control loop. The internal electronic components are isolated from ground. Grounding the case is unnecessary for functional purposes but grounding the case may be necessary to conform to local codes.*

## Powering Up the SVI II ESD

Verify the wiring and connections and then connect the current source.



*For hazardous location installation refer to the Masoneilan SVI II ESD Quick Start Guide (GEA19520 or PN 055201359-999-0000).*

## Connecting a Power Source

Depending upon the configuration of the SVI II ESD, powering up the unit consists of connecting to the 4-20 mA current source or the 24 VDC power source.



*This process can cause the valve to move. Before proceeding ensure the valve is isolated from the process. Keep hands clear from moving parts.*



*When an SVI II ESD is turned on it is advisable to apply the air supply before applying the electrical input signal.*

## Powering Up the ASD Configuration

The ASD, or Analog Safety Demand, configuration uses a 4 - 20 mA current source for power.



*Use of a low impedance voltage source damages the SVI II ESD. The current source must be a true high impedance current limiting device. A proper current source explicitly enables adjustment of the current in mA, not Volts.*

To power up the ASD configuration of the SVI II ESD:

1. Loosen the four (4) cover screws and remove the cover of the SVI II ESD.
2. Connect the  $\mp$  terminals of the current source to the 4 - 20 mA IN connector (on the terminal board). The current source + must connect to the terminal board connector +, and the same for -. See Figure 54 on page 83.
3. Reinstall the cover and display.
4. Adjust current to 20 mA.  
On initial power up of a newly installed SVI II ESD, the PST controller starts up in SETUP mode using the default factory-installed instrument parameters. Once calibrated and configured and set to NORMAL, the PST controller cycles through the NORMAL cycle menu and the following values appear:
  - PRES: Pressure - unit of measurement and value



- SIGNAL
- POS (Position)  
An exclamation point (!) appears in the display's top left corner to indicate that further instrument status is available.

### **Powering Up the DSD Configuration**

The DSD, or Discrete Safety Demand, configuration uses a 24 VDC power source.

To power up the DSD configuration of the SVI II ESD:

1. Loosen the four (4) cover screws and remove the cover of the SVI II ESD.
2. Connect the +/- terminals of the 24 VDC power source to the 24 VDC ESD IN connector (on the terminal board). The voltage + must connect to the terminal board connector +, and the same for -. See Figure 55 on page 84.
3. Reinstall the cover and display.
4. Turn on the voltage source. On initial power up, of a newly installed SVI II ESD, the PST controller runs in SETUP mode using the default instrument parameters installed at the factory. Once calibrated and configured and set to NORMAL, the PST controller cycles through the NORMAL cycle menu and the following values appear:
  - PRES: Pressure - unit of measurement and value
  - SIGNAL
  - POS (Position)  
An exclamation point (!) appears in the display's top left corner to indicate that further instrument status is available.

### **Powering Up the A/DSD Configuration**

The A/DSD, or Analog/Discrete Safety Demand, configuration uses both a 4 - 20 mA current source (for the unit) and a 24 VDC source (for the safety trip) for power.

#### **CAUTION**



*Use of a low impedance voltage source damages the SVI II ESD. The current source must be a true high impedance current limiting device. A proper current source explicitly enables adjustment of the current in mA, not Volts.*

To power up the SVI II ESD:

1. Loosen the four (4) cover screws and remove the cover of the SVI II ESD.
2. Connect the +/- terminals of the current source to the 4 - 20 mA IN connector (on the terminal board). The current source + must connect to the terminal board connector +, and the same for -. See Figure 53 on page 78.
3. Reinstall the cover and display.
4. Adjust current to 20 mA.

5. Connect the +/- terminals of the 24 VDC power source to the 24 VDC ESD IN connector (on the terminal board). The voltage source + must connect to the terminal board connector +, and the same for -. Figure 56 on page 84.
6. Reinstall the cover and display.
7. Turn on the voltage source. On initial power up of a newly installed SVI II ESD, the PST controller runs in SETUP mode using the default factory-installed instrument parameters. Once calibrated and configured and set to NORMAL, the PST controller cycles through the NORMAL cycle menu and the following values appear:
  - PRES: Pressure - unit of measurement and value
  - SIGNAL
  - POS (Position)  
An exclamation point (!) appears in the display's top left corner to indicate that further instrument status is available.



*The safety function of the SIF (shutdown of the valve on demand) must be tested after installation.*

## Checking the Electronic Module Connections



*Do not remove the instrument cover or connect to an electrical circuit in a Hazardous Area unless the power is disconnected.*

All connections to electronic module in the SVI II ESD are made through the terminal board. There are three versions of the terminal board dependent upon which configuration the SVI II ESD you have; ASD, DSD, or A/DSD. The SVI II ESD terminal board has a terminal block with cage clamp connectors. Confirm that all applicable connections to the electronics module connectors are correct. Not all options are available for every model. Refer to Table 8 for available functionality.

**Table 8 SVI II ESD Models and Functionality**

I/O ON SVI II ESD	Usage		
	SVI II ESD ASD Analog Safety Demand	SVI II ESD DSD Discrete Safety Demand	SVI II ESD A/DSD Analog Power with Discrete Safety Demand
Analog In (4-20 mA)	Safety Trip Signal + HART <sup>®</sup> + Analog PST	Not Used	Device Power + Analog PST + HART <sup>®</sup>
ESD In (0-24 VDC)	Not Used	Safety Trip Signal + HART <sup>®</sup>	Safety Trip Signal
Analog Out (4-20 mA)	Position Transmitter	Position Transmitter	Position Transmitter
SW1 (1 A, 24 VDC)	Not Configurable	Not Configurable	Not Configurable
SW2 (1 A, 24 VDC)	Configurable Status	Configurable Status	Configurable Status
DI (switch input)	Unlatch (1)	Unlatch (1)	Unlatch (1)
PV (1-5 VDC)	Read Tight Shutoff Flow (2)	Read Tight Shutoff Flow (2)	Read Tight Shutoff Flow (2)
Local LCD / Buttons	ESD Status Local PST	ESD Status Local PST	ESD Status Local PST

- (1) Latching is software configurable.
- (2) 1 - 5 VDC variable is sent using HART<sup>®</sup> command #3 as the variable TV.

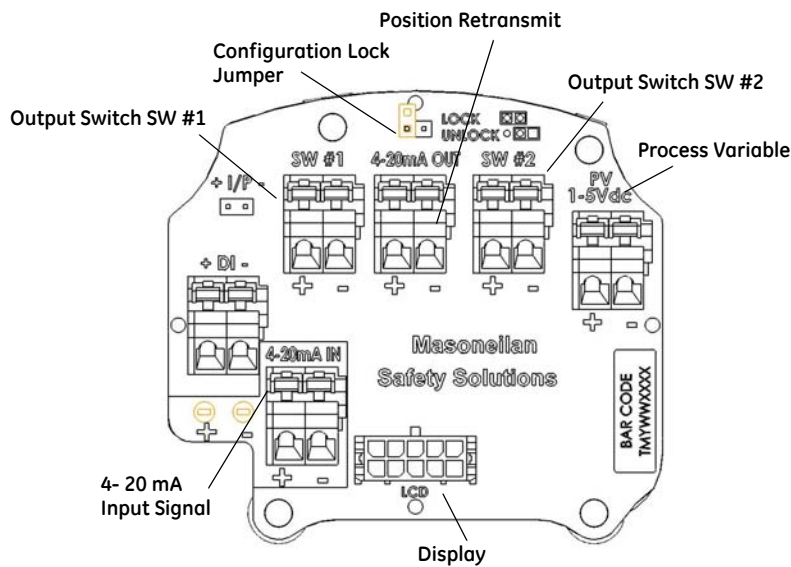

**Figure 54 Connections to ASD Electronics Module (via Terminal Board)**

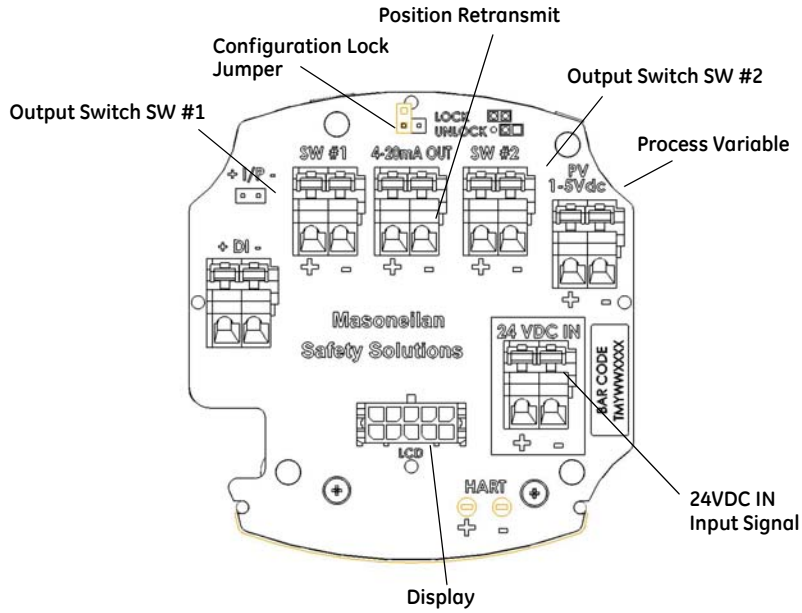

Figure 55 Connections to DSD Electronics Module (via Terminal Board)

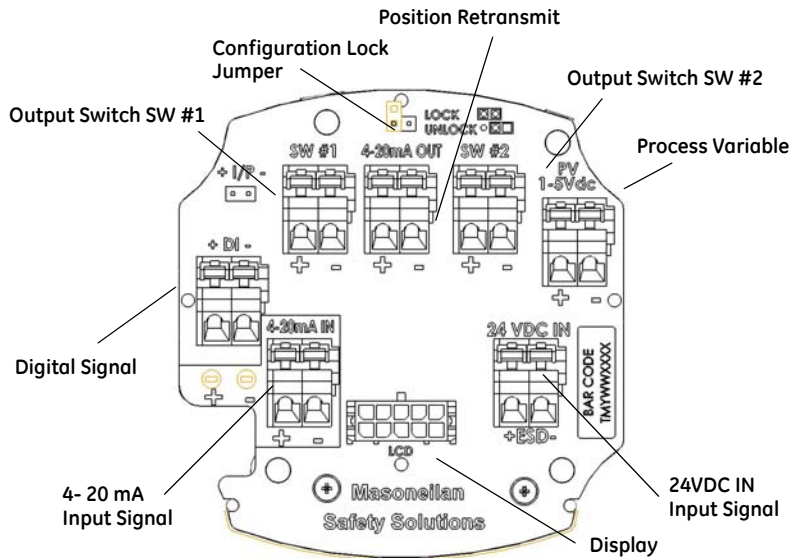

Figure 56 Connections to A/DSD Electronics Module (via Terminal Board)



Connections for available options are activated using SMARTs Assistant.

## Making Connections to the Terminal Board

Each terminal block on the terminal board has a cage clamp connector. One side of the connector has the actual connection for the wire, with a lever at the top. If there is an option present that is not properly connected to the terminal board or if adding a new option, connect the wires from the option as follows:

1. If the option's wires have not been stripped, strip the insulation at the end of wires.
2. Locate the correct terminal block on the terminal board (see Figure 54 on page 83).
3. Push the lever back at the top connector until you see the opening for wire insertion. The connectors are spring activated and may require a lot of pressure to move the lever.
4. Insert the wire into the opening and release the lever.

### NOTE



*Improperly or inadequately grounded installations can cause noise or instability in the control loop. The internal electronic components are isolated from ground. Grounding the case is unnecessary for functional purposes but grounding the case may be necessary to conform to local codes. Side loading the cage clamp lever can cause damage.*

# SVI II ESD Maintenance

## Repair and Replacement

Repairs may be made only by the factory authorized personnel trained to repair Safety Devices.

### CAUTION



*When working on safety rated equipment appropriate risk reduction safety measures must be in place.*

1. A conservative approach is taken in estimating the service interval for the digital valve controller in Safety Instrumented Systems. For SIS applications, perform preventive maintenance on the SVI II ESD after five years from the shipment date, if the average daily ambient temperature is below 60°C (140°F). Where ambient temperature exceeds 60°C (140°F) for extended periods, reduce this maintenance interval based on plant experience.
2. SVI II ESD preventive maintenance consists of replacing gaskets, O-rings in the device and a visual inspection of moving components to verify satisfactory condition. Following maintenance, the SVI II ESD must be reinstalled on the valve actuator and calibrated per the procedures. After calibration, validate the SVI II ESD functional safety. All maintenance procedures must be performed only by the factory authorized personnel trained to repair Safety Devices.
3. If alarms or alerts are detected during operation, maintenance or periodic inspection and test, immediately take corrective action according to the troubleshooting and repair procedures given in the Instruction Manual.

## Factory Notification

Report any failures detected that compromise functional safety to the factory. Contact your local the factory service representative. Sales Office locations are listed on the back cover of this document.

### NOTE



*BHGE does not assume responsibility for the selection, use, or maintenance of any product. Responsibility for proper selection, use of any BHGE product remains solely with the purchaser and end-user. The SVI II ESD requires recertification, which must be performed by factory authorized personnel trained to repair Safety Devices.*

The contents of this publication are presented for informational purposes only, and while every effort has been made to ensure their accuracy, they are not to be construed as warranties or guarantees, express or implied, regarding the products or services described herein or their use or applicability. We reserve the right to modify or improve the designs or specifications of such products at any time without notice.

## Display Cover Removal and Installation

The cover with display (shown in Figure 19) is standard with the SVI II ESD. If you to replace the display cover, follow the instructions below for removal and installation.

### Tools Needed for Cover Replacement

- 5 mm hex key for the cover
- 3 mm hex key for the lanyard

### Removing the SVI II ESD Display Cover

To remove the SVI II ESD Display cover:

1. Using a 5 mm Hex key unscrew the four screws around the perimeter of the SVI II ESD cover.
2. Lift the cover off the PST controller.

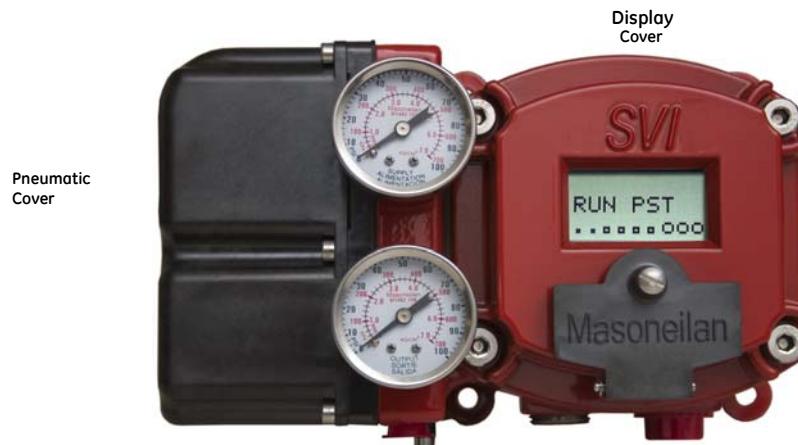

Figure 57 SVI II ESD Pneumatic and Display Covers

## Installing the SVI II ESD Display Cover

The replacement Display Cover is shipped with a lanyard to prevent the cable (that connects from the display to the Terminal Board) from breaking. Insert the lanyard under the screw in the lower left corner that attaches the terminal board to the SVI II ESD housing.

To install the cover:

1. Install the lanyard and tighten the screw to 5 in/lb.
2. Using a 3mm hex key, remove the screw from the lower left corner, connecting the terminal board to the SVI II ESD housing.
3. Connect the cable from the display into the LCD connector on the terminal board.
4. Ensure that the gasket is in its groove in the housing.
5. Place the cover over the screw mounts.
6. Tighten the four screws with the 5 mm hex key.
7. After installing the new display “Powering Up the SVI II ESD” on page 80



*The cover of the SVI II ESD is a critical component for safety in Hazardous Areas. To ensure safe operation the flat surfaces of the cover and the housing must be clean and absolutely free of particles or dents. There must be no gap between the housing and cover; torque spec is 50 in/lb.*

Ensure that:

1. The gasket is seated in the groove in the housing flange.
2. No wires or retaining cable can be trapped under the cover flange.
3. The flange area is not corroded and the surface is not scarred.
4. The four cover bolts are securely tightened to 50 in/lb.



# 5. Configuration and Calibration

## Overview

This section provides information on SVI II ESD setup and calibration procedures to ensure proper valve positioning.



You should perform setup and calibration procedures in this section before putting the SVI II ESD into operation as the SIF.

## SVI II ESD Setup

Pushbuttons and local display are thoroughly described in “Pushbuttons and Local Display” on page 103 of this manual.

### Using the Pushbuttons and Display

When configuring or calibrating a valve equipped with SVI II ESD, using the pushbutton display, the following steps are recommended:

1. Change mode to Manual mode.
2. Examine and adjust all Configuration items.
3. Enter Calibration mode.
4. Run Stops to automatically calibrate stroke. An accumulated value of 100% travel = 1 stroke. The travel does not need to occur in one movement.
5. Run Auto Tune to set dynamic response.
6. Examine device Status.
7. Introduce manual set point changes to verify dynamic performance.

## Configuration

To perform configuration and calibration you can use either pushbutton display, HART<sup>®</sup> handheld communicator, HART<sup>®</sup> Host with the DD loaded, or ValVue ESD software. Refer to “Pushbuttons and Local Display” on page 103 or the SVI II ESD Help for instructions.

The following section describes configuration and calibration procedure using optional local display and pushbuttons.

### WARNING



*These procedures can cause the valve to move. Before proceeding be sure that the valve is isolated from the process. Keep hands clear from moving parts.*

## Configuration with Pushbutton Display

To change the current configuration parameters:

1. After power up, if SVI II ESD is not in *NORMAL* mode, switch to *NORMAL* mode. The display alternates between *POS* and *SIGNAL* indicating *NORMAL* mode.
2. Press **+** to until *MANUAL* appears.
3. Press **\*** to select *MANUAL* mode. The display alternates between *POS -M* and *SIG* indicating *MANUAL* mode.
4. Press **\*** and *SETUP* appears.
5. Press **\*** again and *√CONFIG* appears.
6. Press **\*** to access *CONFIGuration* menu.
7. Set the configuration parameters: *Air Action*, *Air Pressure Units* and *Language* by:
  - a. Pressing **\*** to access and change the parameter.
  - b. Pressing **+** to move to the next parameter.
8. Press **+** to return to *SETUP*.
9. Press **+** to return to **NORMAL** mode.

## Viewing Configuration Data

To view SVI II ESD configuration data:

1. Access **VIEW DATA** menu from *MANUAL* menu by pressing the **+**.
2. Press **\*** to examine configuration. Table 9 lists the menu items.

**Table 9 VIEWDATA Settings**

Configuration Parameter	Typical Setting	Optional Setting	
Air Action	ATO	ATC	
Air Pressure Units	PSI	BAR	KPA
Language	ENGLISH	FRENCH, GERMAN, ITALIAN, PORTUGUESE, SPANISH, JAPANESE (simplified)	

3. Press **+** to scroll through and observe the factory configuration.
4. Press **+** until *MANPOS* appears and press **\***. The adjustment screen appears.
5. Stroke the valve open by holding **+** down. The rate of set point change is slow to begin, but increases speed while the **+** is pressed.
6. Stroke the valve to several values.
7. Verify the action is as desired.

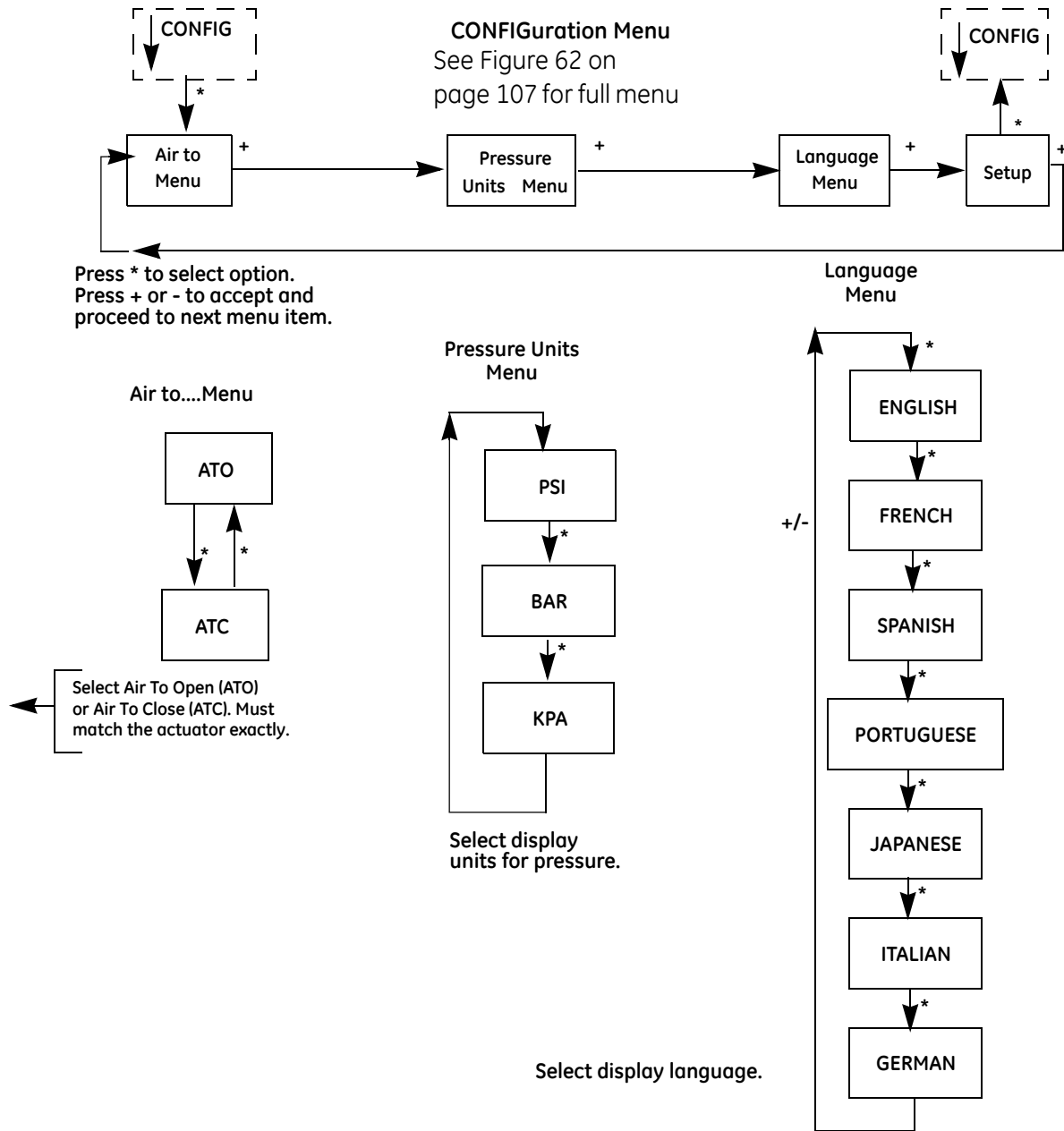

**Figure 58 Configuration Pushbutton Guide**

## Calibration with Pushbutton Display

### CAUTION



*Pilot Trim Valve Applications require the use of the Manual Stop calibration procedure. Do not run Find Stops or ValVue ESD Setup Wizard on valves with Pilot Trim or damage to the valve occurs.*

### NOTE



*Always perform configuration before running calibration functions.*

In order to calibrate SVI II ESD using the pushbutton display, it must be in SETUP mode. To calibrate the SVI II ESD:

1. On power up, if SVI II ESD is not in NORMAL mode, switch to *NORMAL* mode. Display alternates between *POS* and *SIGNAL* indicating *NORMAL* mode.
2. Press **+** to access *MANUAL* mode and *MANUAL* appears.
3. Press **\*** to select the *MANUAL* mode and the display alternates between *POS -M* and *SIG* indicating *MANUAL* mode.
4. Press **\*** and *SETUP* appears.
5. Press **\*** and *√CONFIG* appears.
6. Press **+** to display *√CALIB*.
7. Select *CALIB* by pressing **\***. *STOPS* appears.
8. Press **\*** to activate the Find Stops calibration procedure. The valve moves full open and back to full closed. Observe all warnings.
9. Press **\*** to cause the valve to stroke and to automatically calibrate valve travel.
10. Wait until *STOPS* procedure finishes, press **+** twice until *TUNE* appears.

## Calibration using Auto Tune

### WARNING



*DO NOT perform STOPS while the valve is controlling the process.*

*Valve must be isolated from the process before starting calibration. Calibration procedure strokes the valve over its full range.*

*DO NOT perform AUTO TUNE while the valve is controlling the process.*

To auto tune the SVI II ESD using the pushbutton display:

1. Press \* to begin Auto TUNE procedure and *TUNE* appears. This takes 3 to 10 minutes and strokes the valve in large and small steps to set PID parameters for best positioning response.  
When auto TUNE proceeds, numerical messages are displayed, indicating the procedure is working.
2. When auto TUNE is complete, *TUNE* appears.
3. Press + repeatedly until  $\uparrow$  *SETUP* appears.
4. Press \* to return to *SETUP* menu and  $\surd$  *CALIB* appears. The valve moves to the value set by the current calibrator.
5. Stroke the valve through its range to verify that movement is as needed.
6. Press + to return to *SETUP*.
7. Press + to return to *NORMAL* mode.

## Troubleshooting Autotune

Autotune, whether using ValVue, pushbuttons, a DD or a handheld, is the best way to tune the valve. If it does not work:

### *Step One*

Autotune again using recommended tuning parameters for the valve is use. The SVI ESD software help offers you instructions in how to enter these parameters in the Autotune procedure. Alternately, Try starting tuning from the 50% position.

Table 10 outlines some effects of parameter changes.

**Table 10 Rough Guide to Effects of Changing PID Values**

Parameter	Rise Time		Overshoot		Settling Time	
	Increase Value	Decrease Value	Increase Value	Decrease Value	Increase Value	Decrease Value
<i>P</i>	Decrease	Increase	Increase	Decrease	Small Effect	Small Effect
<i>I</i>	Small Effect	Small Effect	Decrease	Increase	Decrease	Increase
<i>D</i>	Small Effect	Small Effect	Decrease	Increase	Decrease	Increase

*Step Two*

Run autotune again after ensuring the:

- Air supply is sufficient and there are no air leaks.
- Linkage is not loose or in an improper position.
- Alarms are cleared.
- Boosters are not too aggressive.
- Valve does not have excessive friction. Add some *Dead Zone* (0.25).
- Mounting is installed correctly.
- Magnet is not out of position.
- Solenoid in supply line should have a Cv that is .25 or higher.

*Other Issues That Affect Autotune*

Valve oscillating fast:

- P* term too high: reduce *P* by ½ and try again
- Booster too hot (aggressive) open by-pass on booster and try again

Valve oscillation slow - friction:

- Increase *I* term by 20-25%
- Add *Dead Zone* – try 0.25%

Valve moves too slowly:

- P* term too low, try increasing by 25%
- Stroking time set to non-zero value.

## Correct for Over Travel

### WARNING



*While Calibration and Configuration are in progress the valve moves. Keep hands clear. Isolate the valve from the process.*

On some valves full travel is larger than nominal valve travel and it may be desirable to have the reported 100% position corresponding to nominal travel, rather than the full stroke. The STOP OP option allows you to perform this correction. Use this procedure if a correction has to be made.

1. From *CALIB* press \* to display *Stops*.
2. Press + to display *STOP OP*.
3. Press \* to move valve to the 100% position.
4. Using the + and - buttons, position the valve to the nominal full open position.
5. Press \* to accept this position as the new 100% position.

## Adjust Input Signal Range

SIG LO displays the input signal that corresponds to the full closed (ATO) or full open (ATC) valve position.

1. In *SIG LO*, if the displayed value is:
  - Correct, press + to advance to the next item and move to step 4.
  - Not correct, press \* to display *SIG LO* value.
2. Use + and - buttons to change the value.
3. Press \* to return to menu and move to next item. SIG LO value must be between 3.8 and 14.0 mA.

SIG HI displays input signal that corresponds to valve full open, ATO, or valve full closed, ATC position.

4. If SIG HI is:
  - Correct, press + to advance to the next item.
  - Not correct, press \* to display *SIG HI* value.
5. Use + and - buttons to change value.
6. Press \* to return to menu and move to next item. SIG HI value must be between 10.0 and 20.2 mA. SIG HI must be greater than SIG LO by, at least, 5 mA. Positioner Calibration is now complete.
7. At -> *MAN*, press \* to return to the *MANUAL* mode. *MAN POS* appears.



## Configuring with ValVue ESD

ValVue ESD provides advanced diagnostic, maintenance capabilities and complete calibration and configuration for SVI II ESD. The software also performs scheduled and on demand Partial Stroke Testing (PST), performs valve diagnostics (proof testing) and provides results in graphic, informational and historical formats. The software has a database to store test results to compare with future results for predictive maintenance. It is password protected against access to remote instruments. It is set up with different administration level features.

ValVue ESD is the most complete and easiest to use configuration tool. ValVue ESD is delivered with each SVI II ESD. ValVue ESD provides a personal computer interface for configuring and calibrating SVI II ESD. Use of these tools is recommended. See the ValVue ESD On Line Help.

### NOTE



*Never connect ValVue ESD software to an SVI II ESD while configuring or calibrating using pushbuttons.*

## Starting ValVue ESD/ESDVue

ValVue ESD creates an icon on your desktop during installation as shown below. Start ValVue ESD by clicking on the icon or activate it by selecting **Windows Start\Programs\ValVue ESD\ValVue ESD**.



ValVue ESD

Figure 59 ValVue ESD Icon

## Check-out with a HART® Handheld Communicator

Connect the HART® Handheld Communicator (HHC) to the SVI II ESD as shown in Figure 60. Refer to Product Manual for HART® Communicator supplied with the HART® Communication device.

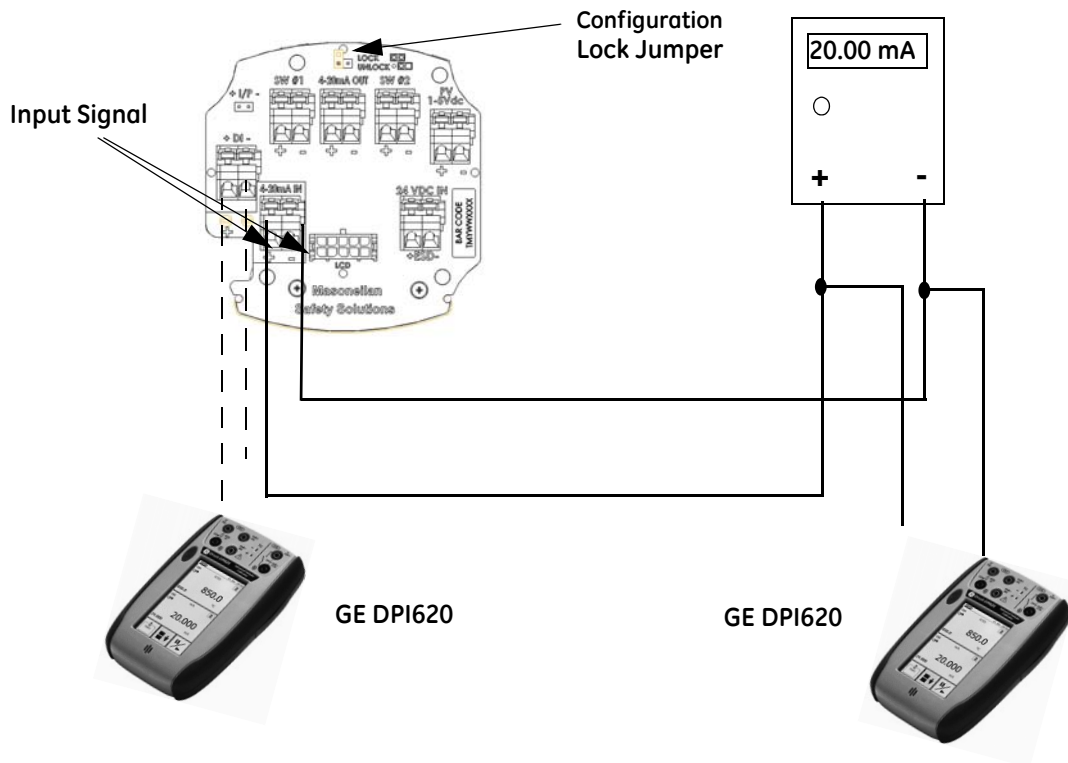

Figure 60 SVI II ESD HART® Communicator Connections

Be sure that configuration lock jumper is in unlock position. When the jumper is in lock position (shorting the two-pin header) the HHC is not allowed to make any changes. However, parameters are readable. If fault messages appear, they must be handled before proceeding with HART® communications. Before communications proceeds all error messages must be cleared. For example, the following message is displayed if the instrument has been serviced and the air is not connected.



*"Process applied to the non-primary variable is outside the operating limits of the field device"*

Proceed with the following steps:

1. Press **NEXT**
2. Field device has more status available
3. Press **NEXT**
4. **Ignore next 50 occurrences** of status?
5. Press **YES**
6. Change to **MANual** mode
7. Scroll to line **6 "EXAMINE,"** press **->**.
8. Scroll down to line **5 read status**.
9. Read message.
10. Press **OK**.
11. Repeat **OK** to read all messages until the display returns to *read status*.
12. Scroll down to line **6 clear status,** press **->**.
13. If **clear fault codes not completed** appears, press **OK** and read the message (**Position Error,** for example) or go to the troubleshooting guide.
14. Correct the problem (Is the air supply on?), and then go to clear status until **Clear Fault codes Completed** appears.
15. Press **OK**.

*This page intentionally left blank.*

# 6. Using the Digital Interfaces

## Overview

This section describes four ways to communicate, configure, and calibrate the SVI II ESD. The SVI II ESD is capable of:

- Annunciating system faults
- Streamlining the safety valve positioning function
- Providing diagnostic information
- Improving precision of process control
- Communicating critical information locally and remotely

The four available communication tools listed below offer increasing levels of functionality.

- Local Display and Push Buttons
- HART® Handheld Communicator
- ValVue ESD
- Any HART® capable Host loaded with the DD for the SVI II ESD

## Local Display and Pushbuttons

The most basic and easiest interface is the local pushbutton and display option mounted on the SVI II ESD. It is available at any time and provides immediate local access to most configuration, parameters, calibration procedure, and fault messages. It is approved for use in Explosion Proof and Intrinsically Safe installations in Hazardous Areas.

## Notes on Aggressiveness

### Setting Aggressiveness

While the SVI II ESD software and the DD allow you to set Aggressiveness, the pushbuttons do not. In all three methods, however, the Aggressiveness value is inherited from any previously performed tuning (Autotune or manual). Once Aggressiveness, and other tuning values are determined, they are stored in NVRAM.

The SVI-IIAP provides a user define Aggressiveness Level for auto-tuning, the allowable range varies from -9 to +9 where 0 (Zero) is consider normal tuning. The Aggressiveness Level influences stroking speed and over-shoot. A negative value will SLOW stroking speed and help minimized over-shoot. A positive value will INCREASE stroking speed and may add some over-shoot. The recommended values for Aggressiveness is 0 for control valves without volume boosters.

In applications with volume boosters and/or quick exhaust valves are used the Aggressiveness Level is not as influential. For Auto-tuning it is usually between 0 and 3. Reduce the volume boosters sensitivity by opening the integral bypass needle valve about 1 to 2 turns. Use caution when adjusting the needle valve so as to not to damage the seat, close gently to seat and then open 1 or 2 turns.

### Aggressiveness Dynamic

Lower values of aggressiveness lead to lower PID values and slower response and less overshoot.

Higher values lead to higher PID values and quicker response and more overshoot.

Once you have a preferred aggressiveness and you tune once, all future autotunes automatically use that same value, until user-changed.

## HART<sup>®</sup> Handheld Communicator

The HART<sup>®</sup> handheld communicator is a universally available tool that provides the same accessibility as the local button and display. The HART<sup>®</sup> tool has the functionality to upload and download configurations, enter alphanumeric messages and set the custom characteristic numerical parameters. The GE DPI620 is approved for Intrinsically Safe use in Hazardous Areas in accordance with SVI II ESD Approvals.

## ValVue ESD

ValVue ESD combines the power of the PC with the features of SVI II ESD for ease of use and automation of positioner operation giving full access to all data. ValVue ESD is provided with all SVI II ESD positioners and is recommended for set up, service and maintenance where a PC or laptop is permitted. See "Configuring with ValVue ESD" on page 97 for further information.

## Pushbuttons and Local Display

Local interface to the SVI II ESD consists of the LCD alphanumeric display and pushbuttons. The SVI II ESD can be controlled locally through the device-mounted pushbuttons and digital display, shown in Figure 61 on page 103. Using the display you can read the input signal, valve position, and actuator pressure. The display switching sequence from one variable to the next is every 1.5 seconds.

Using pushbuttons you can change operating modes at any time and step through a menu structure to perform manual operation, calibration, configuration, and monitoring functions. SVI II ESD provides internal diagnostics and if a fault is detected it appears on the display. ValVue ESD provides advanced diagnostic functions. The pushbuttons do not support ValVue ESD advanced diagnostics functions.

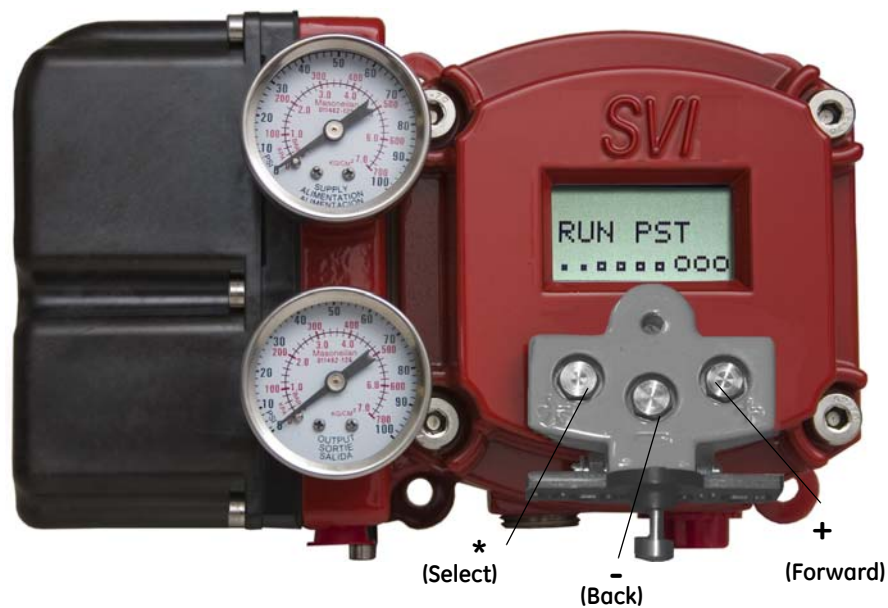

Figure 61 SVI II ESD Display

Table 11 lists menus items and functional descriptions, including parameters if applicable.

**Table 11 Pushbutton Display Menus**

Pushbutton Menu	Function/Parameters
NORMAL	Runs SVI II ESD in normal operating mode, displays position, signal and pressure.
MANUAL	Executes manual mode in which the valve does not respond to input signal and you can adjust position manually. In MANUAL mode the valve responds to the Trip signal in addition to responding to HART <sup>®</sup> . MANUAL mode menu provides access to SETUP.
SETUP	SETUP menu provides access to lower level setup menus; configuration (CONFIG), calibration (CALIB) and PST configuration.
CONFIG	Using CONFIG (configuration) menu you can set the following parameters: ATO/ATC, Pressure units, display language.
CALIB	Using CALIB (calibration) menu you can calibrate SVI II ESD by running STOPS (find stops) and TUNE (autotune) functions.
PST CONF	Using PST CONF (PST configuration) menu you can configure the following PST parameters: TRAVEL (adjustable from 0 to 100% of travel rating), PMIN (minimum allowed pressure during PST), MAX TIME (maximum allowed time in seconds for partial stroke), PST SPEED (the valve travel speed in% travel per second).
VIEW DATA	The VIEW DATA menu displays the parameters set in CONFIG and PST CONF.
VIEW ERR	The VIEW ERR menu displays all current errors.
CLR ERR	The CLR ERR menu allows you to clear current errors, one at a time.
RUN PST	The RUN PST menu executes PST (Partial Stroke Testing)



## Accessing Pushbuttons

The local pushbuttons are located behind a hinged cover, directly below the display window. To open the cover loosen the screw and swing the cover down. Always re-fasten the cover after use to protect pushbuttons from environmental contamination.



*When an exclamation mark (!) appears in the SVI II ESD display window, it indicates that there is instrument status available.*

The three pushbuttons perform the following functions:

- *Left Button* - Marked with \*, *selects* or *accepts* the value or parameter option currently displayed.
- *Middle Button* - Marked –, moves back through the menu structure to the previous item in the menu or decrements the currently shown value in the digital display. Holding down the button causes the value to decrease at a faster rate.
- *Right Button* - Marked +, moves forward through the menu structure to the next menu item, or increments the currently shown value in the digital display. Holding down this button causes the value to increase at a faster rate.

## Pushbutton Locks and Configuration-Lock Jumper

Before performing any configuration or calibration functions using the local display you must first ensure that the pushbuttons are placed in unlocked mode using ValVue ESD. The positioner is factory set in unlocked mode. See ValVue ESD On Line Help for more details.

The SVI II ESD offers several security levels. It may be desirable, after initial setup, to lock the pushbuttons so that the SVI II ESD parameters cannot be inadvertently changed by buttons. Several levels of software modifiable pushbutton locks are provided.

**Table 12 Pushbutton Lock Security Level**

Level	Access
Security Level 3	Allow Local Buttons: Buttons on SVI II ESD are fully enabled.
Security Level 2	Lock Out Local Calibration and Configuration: Use the buttons to perform operations in normal operating mode and manual mode. Do not go to configure or calibrate mode.
Security Level 1	Lock Out Local Manual: Examine variables in normal operating mode but do not put valve in manual operating mode. Access to calibrate or configure modes is not available.
Security Level 0	Lock Out All Buttons: Buttons are disabled (level 0).

## Hardware Configuration Lock

Additional security is achieved by using the hardware configuration-lock jumper shown in Figure 26 on page 43 through Figure 28 on page 44 (based upon SVI II ESD model). When set to secure position, shorting the two-pin header, configuration and calibration are not permitted using local interface or by remote communications. Pushbuttons, ValVue ESD and GE DPI620 are locked out, except to examine configuration, calibration, and position. This is similar to Security Level 1 shown in the Pushbutton Lock Security Level table.

# Display Menus

To determine how to display and select a specific parameter value or configuration option, refer to menu structure diagrams shown in Figure 62 through Figure 66 on page 113. When using these diagrams as a flow chart you can move through menus to the needed function.



*If the pushbuttons are pushed after being locked by ValVue ESD software, the message BTN LOCK appears.*

## NORMAL Operating Mode and MANUAL Mode Menus

Leaving NORMAL mode to go to MANUAL mode causes the valve to move to the last position it was in when leaving NORMAL mode. When in the MANUAL mode the device does not respond to the 4 - 20 mA signal. However, the SVI II ESD unit can still respond to HART® commands, including HART® commands to position the valve. When you switch to VIEW DATA or VIEW ERR menus from the NORMAL operate mode menu, the valve is still in NORMAL mode and responds to the 4 - 20 mA signal.

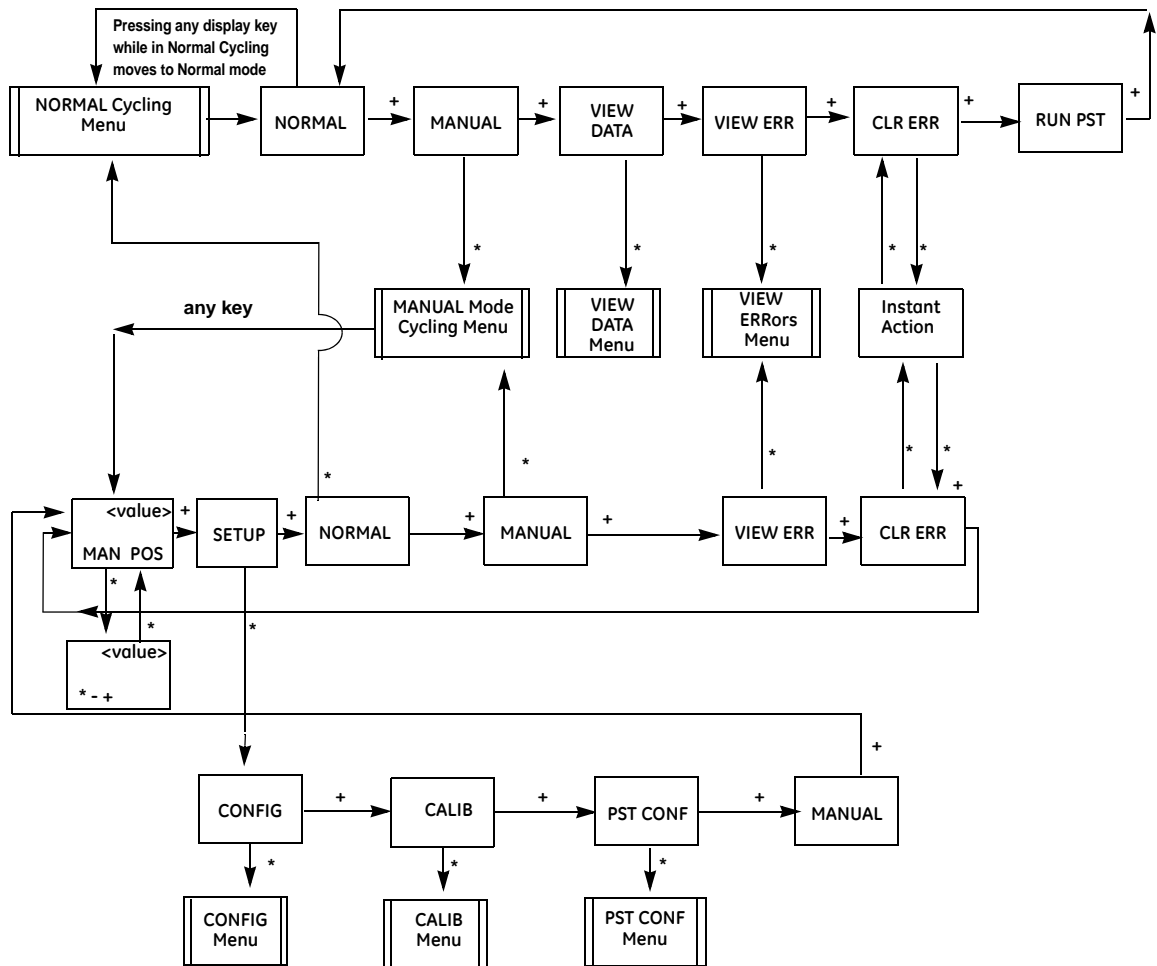

Figure 62 NORMAL Operation and MANUAL Menu Structures

## Configure Menu

When installing an SVI II ESD for the first time you have to perform configuration before calibration because configuration can affect calibration.

If a change is made in the Air-to-Open / Air-to-Close configuration option or if you move the SVI II ESD to a different valve or make any change to the valve position linkage, you must run the find STOPS calibration again.

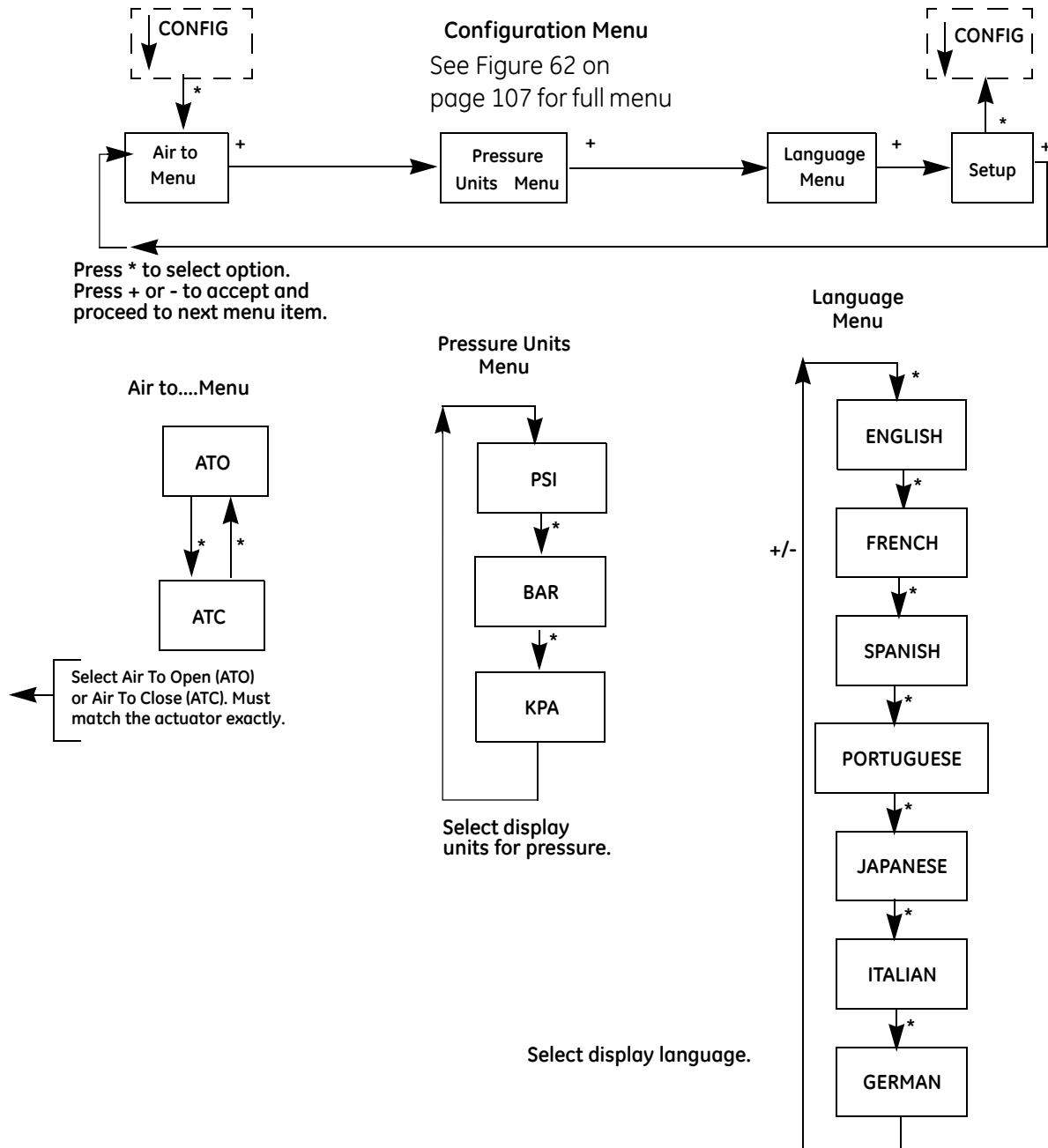

Figure 63 Configure Menu

## ATO / ATC

The positioner must be configured as Air-to-Open, ATO, or as Air-to-Close, ATC. This parameter is toggled by the \* button.

To determine if a direct acting positioner has to be considered ATO or ATC perform the following test:

### WARNING



*This procedure can cause the valve to move. Before proceeding be sure the valve is isolated from the process. Keep hands clear from moving parts.*

1. Apply actuator's rated pressure to the positioner supply. Do not exceed actuator pressure rating listed in control valve specification sheet. Damage to the valve stem, shaft, or trim can occur.
2. Disconnect electrical (4 to 20 mA) input signal from the positioner or set it to less than 3.6 mA.
3. Observe the control valve position. If the valve is closed the actuator is ATO. If the valve is open it is ATC.

## Pressure Units

Select display units for the optional actuator pressure sensor. The available choices are PSI, BAR or KPA.

The choice applies to local LCD display, ValVue ESD software display, and to HART<sup>®</sup> Handheld communicator.

1. Press \* to move from PSI to BAR to KPA.
2. Press + to continue to scroll through the config menu.

### NOTE



*The characteristic configured in the positioner is applied in addition to the plug characteristic built into the valve trim. Do not configure a percentage characteristic if the valve has a percentage plug.*

## Changing Language

The local display language can be set to English, French, Spanish, Portuguese, Japanese, Italian or German.

1. Press \* to toggle from ENGLISH to other language selections.
2. After you have selected the appropriate language, press + to continue to scroll through Config menu.



## PST Configuration Menu

The PST Configuration menu shown in Figure 65 provides access to all configuration functions to run PST. Refer to "PST Configuration" on page 122.

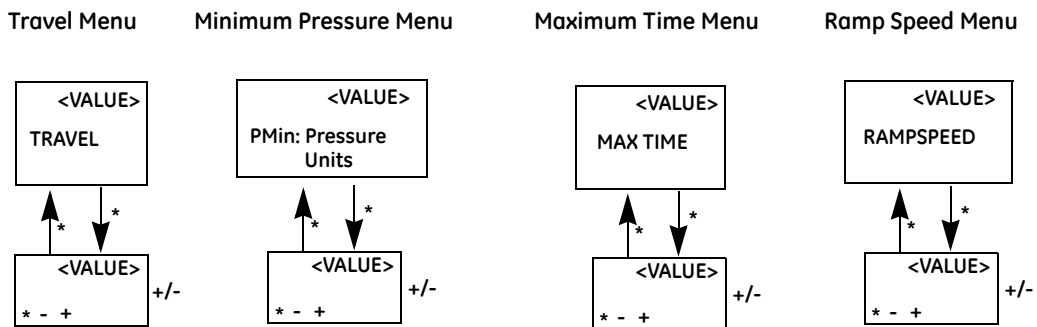
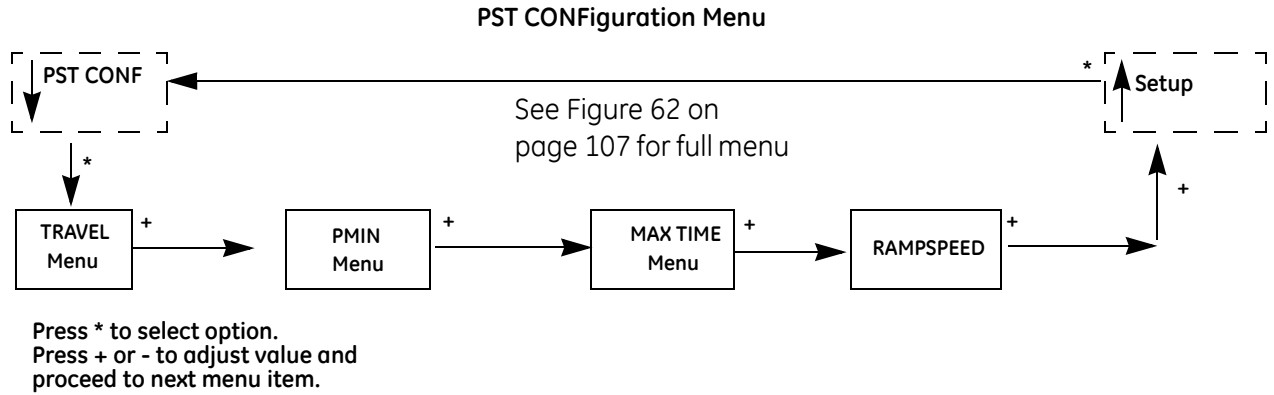

Figure 65 PST CONFIguration Menu

## VIEW DATA Menu

The VIEW DATA menu reads current configuration information, including PST configuration. This information cannot be changed from the VIEW DATA menu. Exit from the VIEW DATA menu to return to the previous menu.

This menu can be entered either from the MANUAL Mode menu or from NORMAL Mode menu.

When entering VIEW DATA from NORMAL mode the valve shall still respond to changes in set point input signal and the displayed values change in accordance with input signal changes. When entered from MANUAL mode, the valve is in locked position. The parameters viewable by pressing + and - are:

- SINGLE
- ATO or ATC
- PSI, BAR, KPA

## Viewing Configuration Parameters

To view configuration parameters use the following procedure:

1. If in NORMAL operating mode, press any button.
2. Press + to move through options until you reach the VIEW DATA menu item.
3. Press \* to go to VIEW DATA menu (This leaves the valve in NORMAL mode.). If in MANUAL mode, press + repeatedly until the VIEW DATA menu item is reached. Press \* to select VIEW DATA mode.
4. To exit from the VIEW DATA menu, press \* at any menu line. You return to the last displayed menu.



See Figure 62 on page 107 for full menu

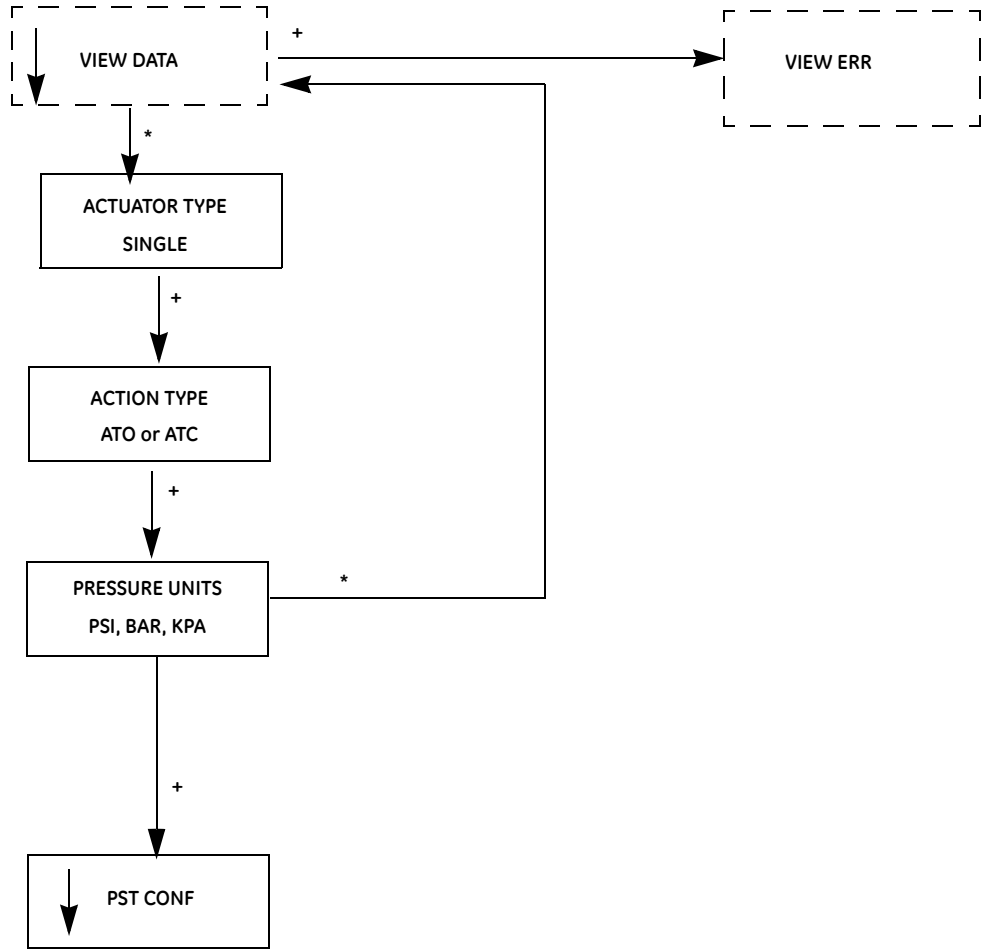

Figure 66 VIEW DATA Menu

## PST CONF (VIEW DATA) Menu

There are two instances of PST CONF (PST CONFiguration) contained in the display menus; one instance can only be accessed from VIEW DATA, the other instance is accessed through SETUP. PST CONF only displays the PST configuration data when accessed from VIEW DATA.



*If you would like to configure Partial Stroke Testing (PST) refer to "PST Configuration" on page 122.*

The PST configuration parameters viewable by pressing + and - are:

- TRAVEL
- PMIN: Pressure Units (PSI, BAR, KPA)
- MAX TIME
- RAMPSPEED

### Viewing PST Configuration Parameters

To view PST configuration parameters use the following procedure:

1. If in NORMAL operating mode, press any button.
2. Press + to move through the options until you reach VIEW DATA menu item.
3. Press \* to go to VIEW DATA menu (This leaves the valve in NORMAL mode.). If in MANUAL mode, press + repeatedly until VIEW DATA menu item is reached. Press \* to select VIEW DATA mode.
4. In VIEW DATA menu, press + repeatedly until the PST CONF menu item is reached. Press \* to select PST CONF mode.

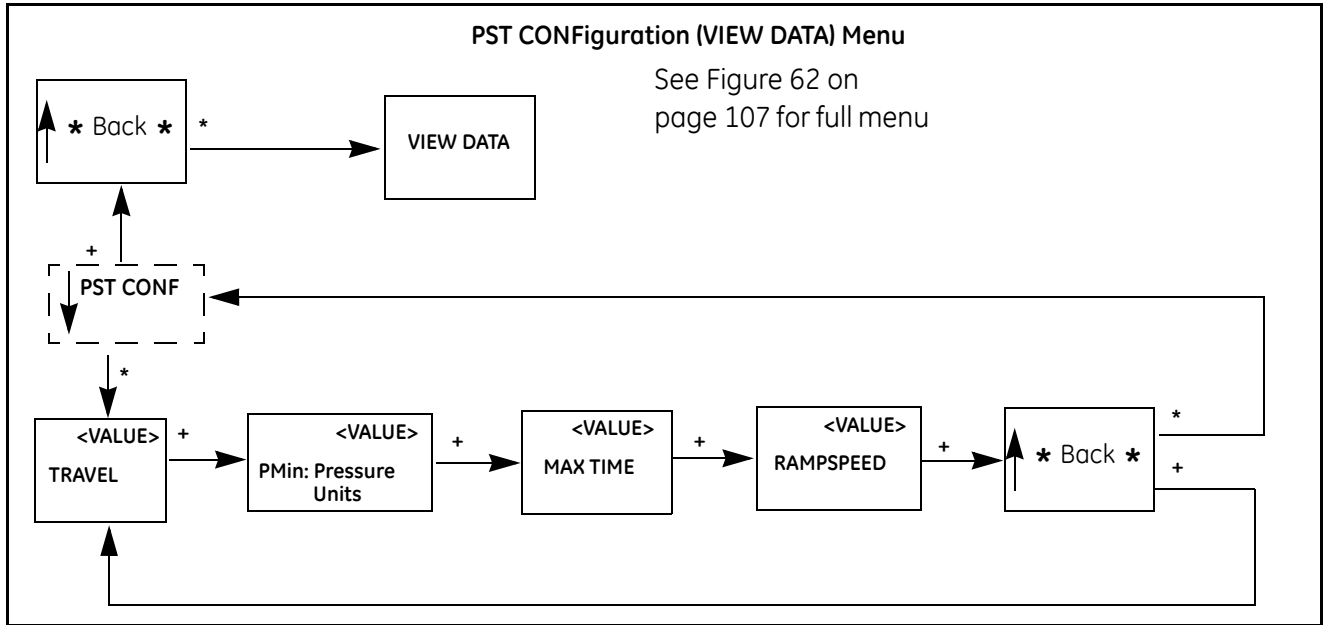

Figure 67 PST CONFIguration (VIEW DATA) Menu

## VIEW ERR

The VIEW ERR menu allows you to view all the current, active errors recorded by the SVI II ESD.

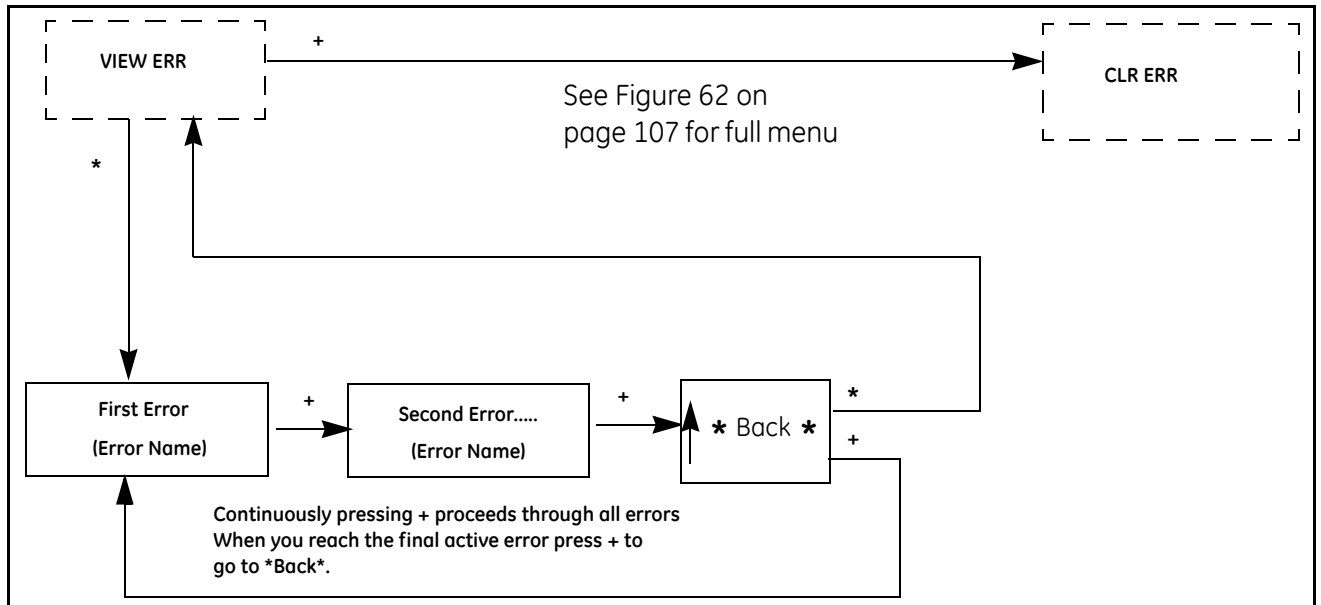

Figure 68 View Err Menu

## Clear Error

Read diagnostic messages in the VIEW ERR menu, accessible from MANUAL Mode menu or from NORMAL Mode menu. The VIEW ERR menu item allows you to read current status information.

To clear error messages:

1. Press \* at CLR ERR on either MANUAL or NORMAL mode menus.
2. Exiting from VIEW ERR menu returns you to the previous menu.

## FAILSAFE Mode

FAILSAFE mode cannot be selected from any of the previous menus. FAILSAFE mode and display are initiated when a critical fault is detected in the positioner or valve system. There are two ways to deal with a FAILSAFE condition: correct the problem then clear the error messages *or* run through FAILSAFE menu, view error messages, enter MANUAL mode and RESET. Note that RESET restarts operation.

When failsafe occurs:

1. Press + to move to VIEW ERR menu.
2. Then press \* to view the first error message. Pressing + scrolls through all fault messages in turn.
3. When the cause of the problem has been corrected, press + to move to CLR ERR menu.
4. Press \* to remove all error messages from memory.
5. Move to MANUAL menu. If you have cleared errors *RESET* no longer appears.

*or*

1. Press + to move to VIEW ERR.
2. Press \* to view the first error message. Pressing + scrolls through all the fault messages in turn.
3. Move to MANUAL and enter Manual mode.
4. Select **RESET** to start the valve from its failsafe condition.
5. After identifying and correcting errors, select **RESET** to return to the previous mode (without removing error messages from memory).

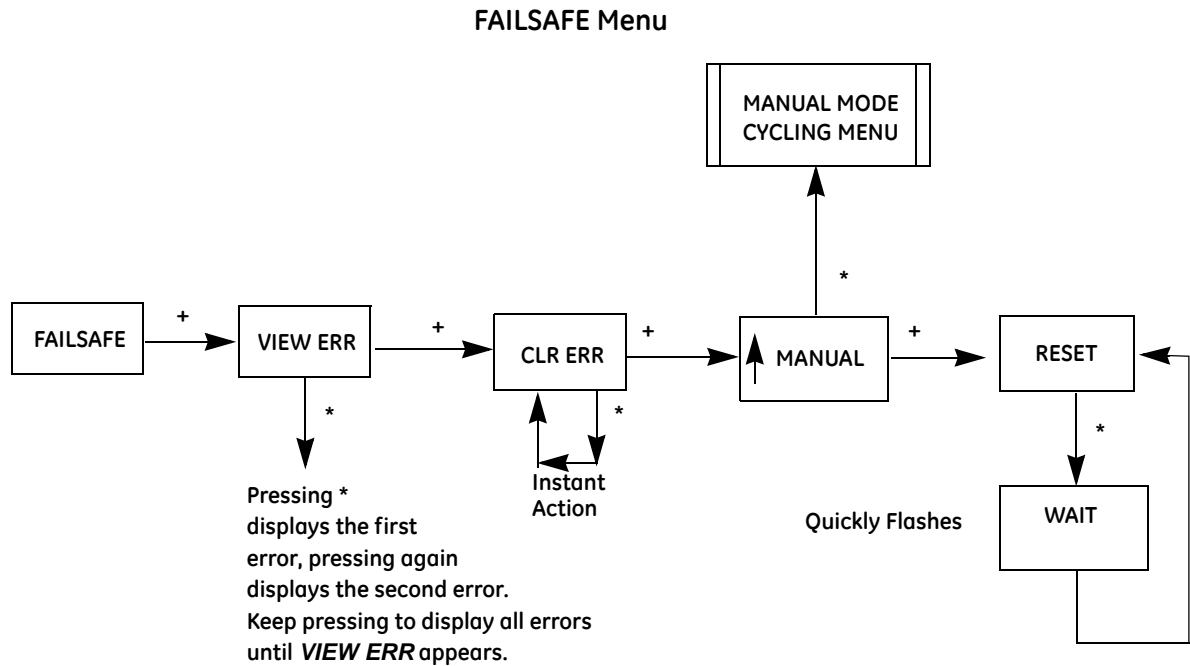

Figure 69 FAILSAFE Menu

## Handheld Communicator

An alternative digital interface to SVI II ESD is the HART<sup>®</sup> handheld communicator. In order to communicate with a HART<sup>®</sup> protocol compliant field device, the Device Description Language has to be used. A dedicated Device Description, DD, is published by registration with Field Comm<sup>®</sup>. When the DD is installed in a host communication device then it can readily access all the information in the smart field device. The SVI II ESD registered DD is available from Field Comm<sup>®</sup>. The SVI II ESD DD can be obtained from the factory or by contacting your local representative.

### WARNING



*Do not connect a HART<sup>®</sup> modem and PC to a control circuit unless the controller is HART<sup>®</sup> compatible or has a HART<sup>®</sup> filter. Loss of control or a process upset can occur if the controller output circuit is not compatible with HART<sup>®</sup> signal.*

*Do not Connect a PC or HART<sup>®</sup> modem to an intrinsically safe circuit except on the safe area side of the barrier. Do not operate a PC in a hazardous area without compliance to local and plant regulations.*

## ValVue ESD

Another digital interface available for the SVI II ESD is Masoneilan's ValVue ESD software. ValVue ESD provides a user friendly interface to facilitate set up and operation of the positioner. ValVue ESD is used to configure, calibrate and perform valve diagnostics with SVI II ESD, utilizing HART<sup>®</sup> communications protocol.

SVI II ESD is delivered with a trial version of ValVue ESD, ready to use without registration. Refer to ValVue ESD On Line Help.

# DD Navigation

HART® DD (Dev v1, DD V4) - SVI II ESD (Applicable to Firmware 3.1.6)

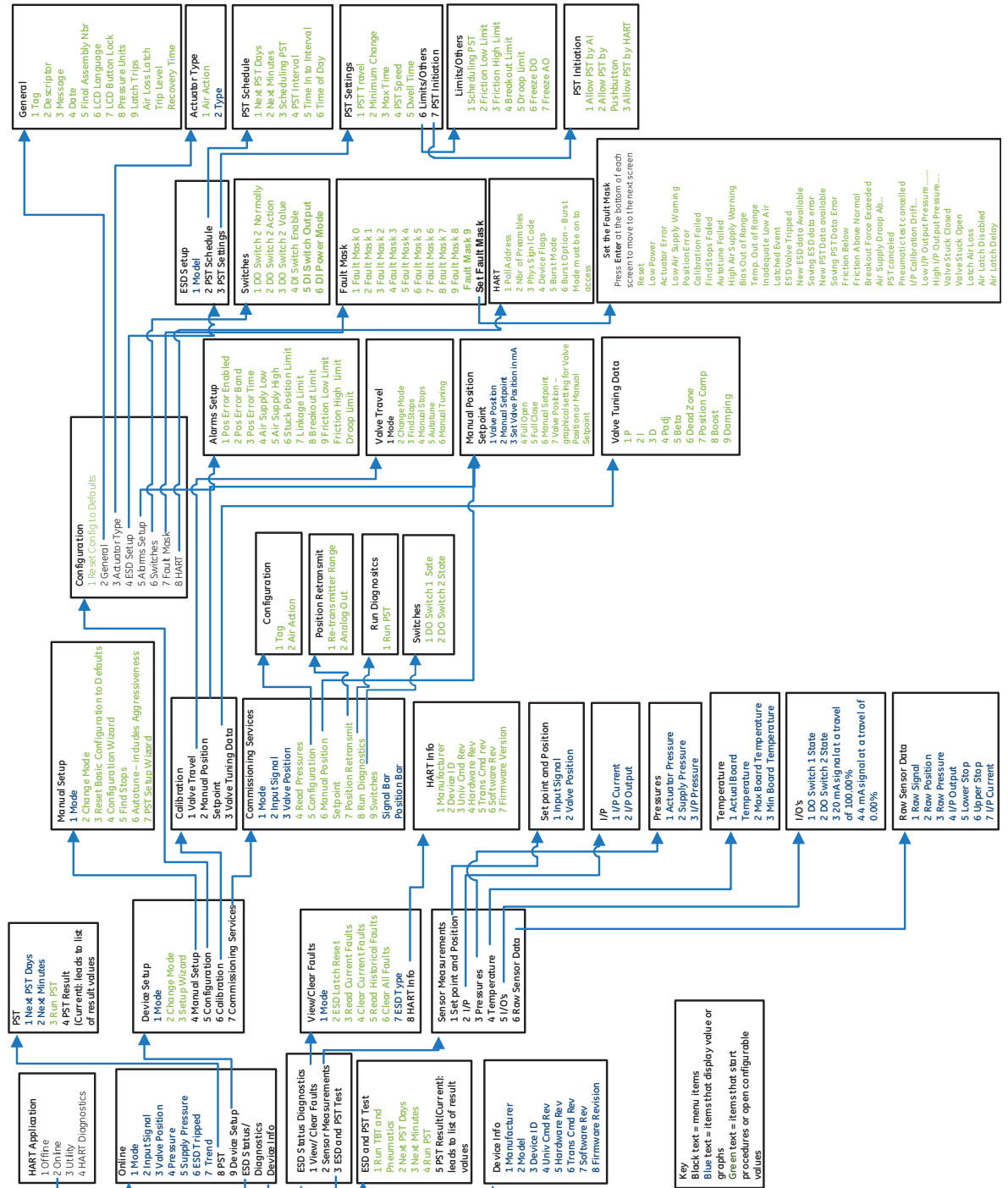

Figure 70 DD Navigation

*This page intentionally left blank.*



# 7. Partial Stroke Testing

## Overview

Key components of Safety Instrumented System (SIS) are final control elements such as emergency shutdown devices, i.e. SVI II ESD. SVI II ESD and its associated valve are not continually moving like a typical control valve, but are normally expected to remain static in one position and then operate reliably upon an emergency event occurrence. Valves remaining in the same position for long periods of time can become stuck and won't operate when needed. To ensure integrity of the ESD valve, SVI II ESD requires periodic testing.

One of the great features of the SVI II ESD is the ability to test the safety valve on-line, without removing it from the SIS. SVI II ESD allows you to automatically, or on demand, perform a Partial Stroke Test (PST) which returns relevant data concerning valve operation and can allow you to detect potentially dangerous failures. PST partially strokes the valve and returns data about the valve's performance.

SVI II ESD is the most advanced PST device with the most integrated sensors to provide complete diagnostic coverage.

Some SVI II ESD Partial Stroke Testing features are:

- ESD and PST Wiring *All in One*
- Minimal Valve Expertise required
- No time wasted in getting Results
- Auto-Analysis ESD Valve Health
- PST Signatures Automatically Retrieved
- Global View of ESD Health

### NOTE



*PST only runs when the SVI II ESD is configured as ATO (Air To Open). You can configure the SVI II ESD with the LCD/Pushbutton display or using ValVue ESD. A trial version of ValVue ESD is provided with every SVI II ESD. Refer to the ESD Help file for further information.*

## Partial Stroke Test Diagnostics

The SVI II ESD is capable of partially stroking the valve to detect failures in the final control element assembly. PST is configured using the pushbutton display or through ValVue ESD.

The PST can be configured to automatically start or be initiated by setting current input to 16.4 mA, local control panel pushbutton, or field initiated by an operator. When configured to run automatically or when initiated through a safety rated logic solver, additional diagnostic credit can be taken for the PST.

## PST Configuration

Before running PST, you must configure the following parameters: travel, maximum pressure, maximum time, ramp speed, and spring. You can configure PST parameters from the pushbutton display or using ValVue ESD. Refer to Table 11 on page 104 for PST configuration parameters.

### PST Configuration with Display Menu

When using the LCD display to configure PST:

1. Access PST Configuration (*PST CONF*) menu. Refer to Figure 62 on page 107 for menu structure.
2. Scroll through each PST parameter and adjust accordingly. PST Configuration menu is displayed in Figure 71 on page 123. The adjustable parameters are as follows:
  - PST Travel* - range is in a percentage of 100% travel over which you want partial stroke testing to occur.
  - Minimum Pressure* - minimum pressure in engineering units allowed during PST.
  - Maximum Time* - allowed time in seconds for partial stroke.
  - Ramp Speed* - travel speed in % of PST travel per second.

Adjust PST configuration parameters by:

- a. Opening *PST CONF* press \* to move into PST configuration menus.
- b. Moving through PST configuration menus by pressing + until the appropriate menu appears.
- c. Pressing \* to activate menu.
- d. Setting values using the +/- button to adjust value.
- e. Pressing \* to leave the active menu adjustment and + button to move to next menu.

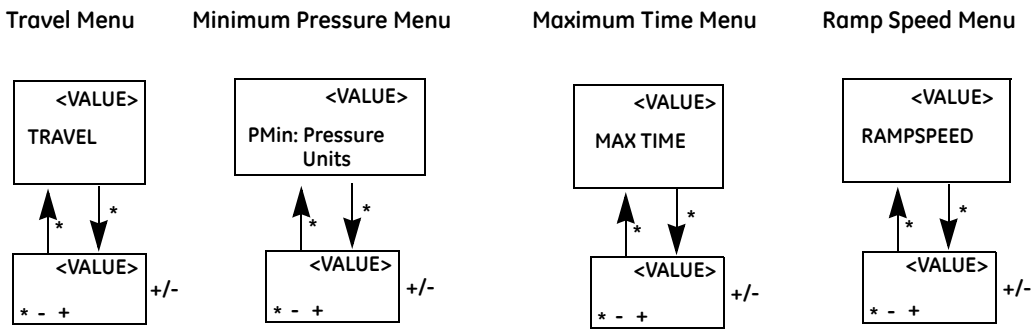
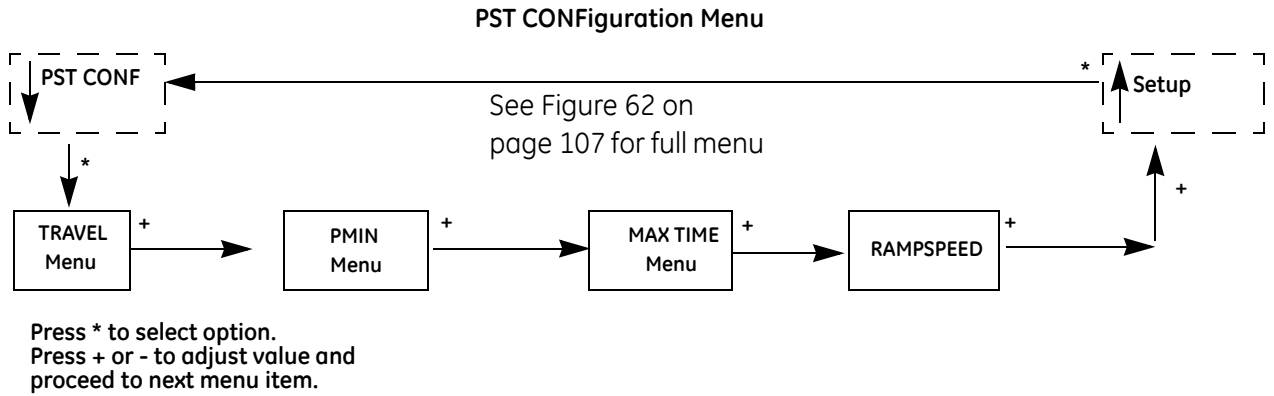

**Figure 71 PST Configuration Pushbutton Menu**

## PST Setup with ValVue ESD

When configuring PST with ValVue ESD, more parameters are available. You can configure dwell time, friction low and high limits, breakout limit, droop limit and can freeze DO and AO switches. ValVue ESD also provides the ability to schedule PST, so that PST automatically runs at the scheduled time. See the help file.

### PST Data from ESDVue



*After you launch a connected device from ValVue ESD, the software tool changes to ESDVue. ValVue ESD is the main interface for detecting and launching SIS devices. After a connected device has been selected, the software tool for connected device is ESDVue.*

When using ESDVue to run PST, ESDVue provides PST feedback in a graphical format. Examples of PST graphical data are shown in Figure 72 and Figure 73.

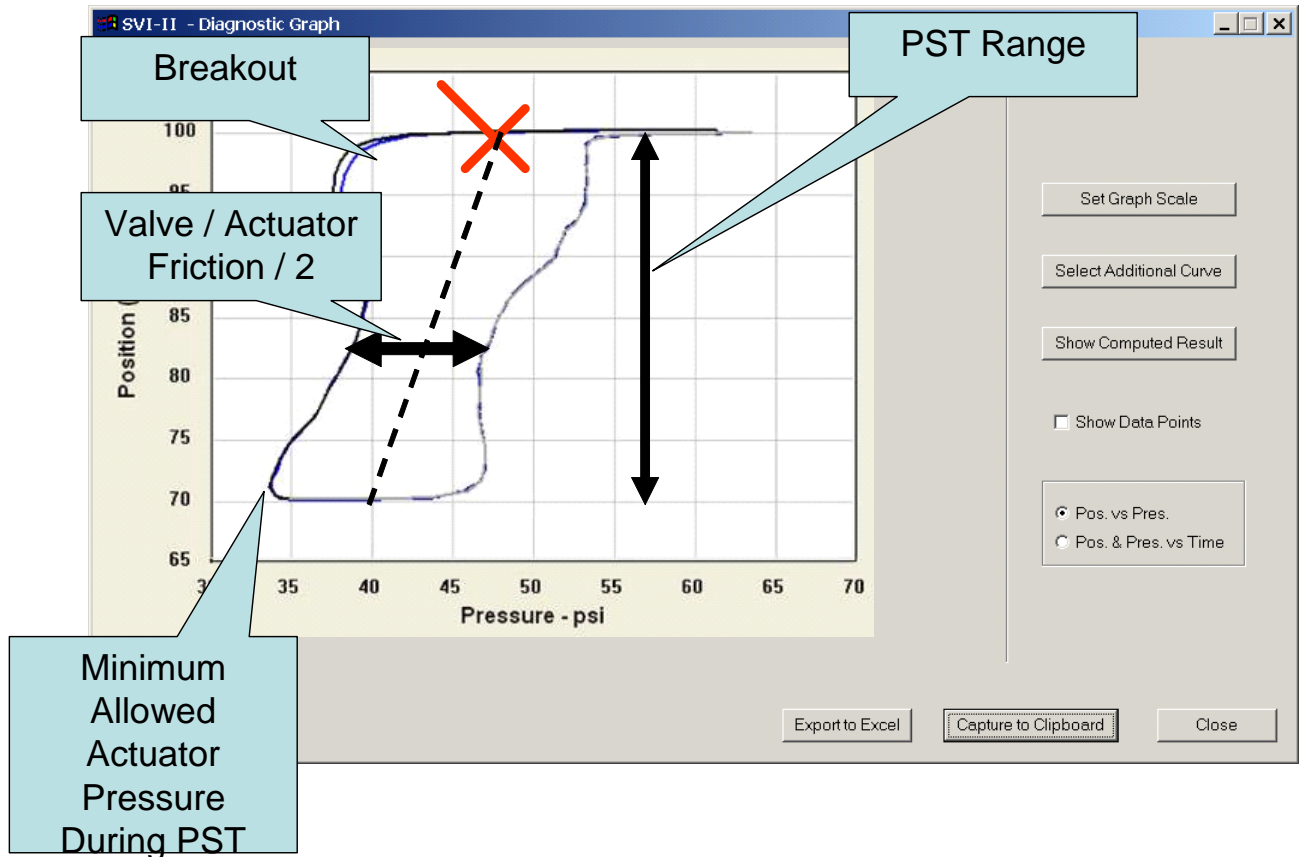

Figure 72 PST Diagnostic Graph Example

- PST Improves Risk Reduction Factor (RRF) and Probability of Failure on Demand (PFD)
- Does Not Disturb the Process
- Increases Duration between Full Proof Testing of ESD's
- Can Reduce the Number of required Valves for the SIF

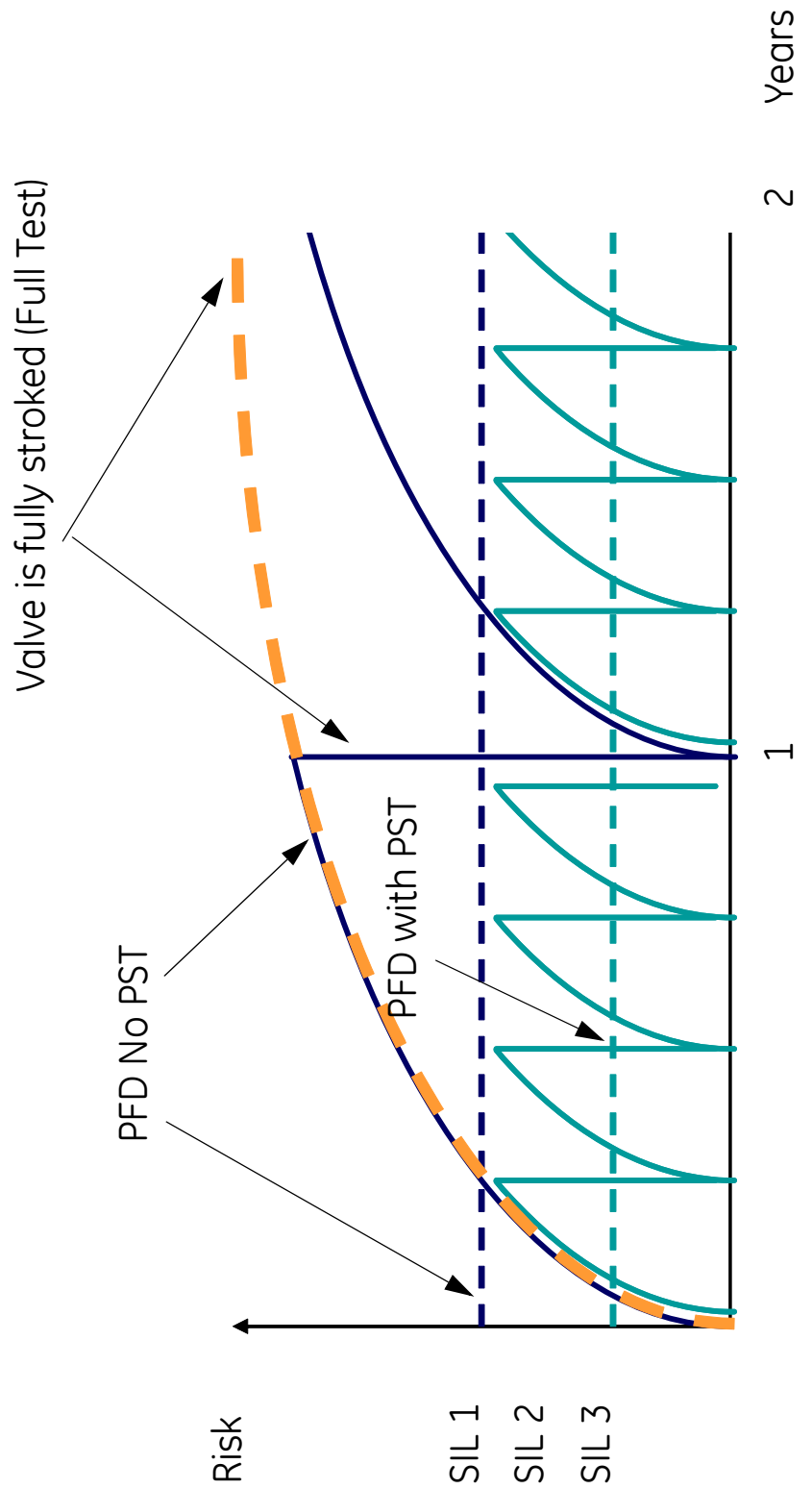

Figure 73 PST Benefits

*This page intentionally left blank.*

# 8. Operation and Maintenance

## Operational Overview

SVI II ESD is Masoneilan's solution to improve safety in a processing plant; it is designed to prevent and mitigate possibly uncontrollable situations. SVI II ESD is a SIL 3 compliant Smart Valve Interface that continuously monitors the ESD valve operation of the and reports any operational failures.

An emergency shutdown valve is a valve that operates to insure a safe state of a plant when process conditions become or could become uncontrollable. Hundreds of ESD valves are part of every petro-chemical and offshore production plant, as well as part of pipeline installations. During normal operation, these valves are energized to stay open, with the means of a solenoid valve. If an unsafe situation occurs, the ESD valve is de-energized. The solenoid valve vents the pressure from the actuator chamber, to atmosphere. The accumulated static energy in the actuator spring, provides the necessary force to bring the valve to its closed position.

Because of its data monitoring capability due to its embedded sensors, SVI II ESD is capable of validating the health of its integral components. The ESD valve partially stroking capacity while in normal operations (energized to stay open), enables validation of valve and actuator assembly health. Periodic ESD valve testing reduces PFD (probability of failure on demand) since exercising the valve reduces the risk of improper operations due to sticking, and confirms if an impending problem would prevent the ESD valve to properly operate.

- The ESD device performs as a *smart* solenoid to pneumatically activate an ON/OFF valve.
- It is primarily used for safety instrumented systems (SIS) that require field devices to be certified for safety related applications according to IEC61508.
- It is certified by TUV for usage to a SIL3 safety integrity level.
- Interacts with a SIS Logic solver.
- Works with existing 24 VDC, 2 wire installations with superimposed HART® communications
- Works with a 4-20 mA signal, 2 wire installations with superimposed HART® communications

- Works with a 4-20 mA control signal as a set-point for 0% or 100% in conjunction with a discrete 0-24 VDC signal as the safety trip trigger.
- Communicates HART<sup>®</sup> over existing wires (4-20 mA or 24 VDC)

In addition, SVI II ESD is a PST controller that mounts on a pneumatically actuated valve assembly. Its role is to position an emergency shutdown valve to 0% or 100% with a probability of failure on demand (PFD) in accordance with IEC61508 for SIL3 application (SIL = Safety Integrity Level). It replaces solenoid valves, typically utilized to actuate a spring-return actuator, while providing extensive online valve diagnostics.

## SVI II ESD Applications and Designated Safety Function Activation

There are three (3) SVI II ESD configurations used to connect to the control system in four (4) different scenarios. The three configurations are used exclusively and cannot be combined in any way. The SIL 3 circuit has complete and independent control to set the IP output to a de-energized state upon demand. The SIL 2 rated annunciation function is the SW #1. HART<sup>®</sup> and AO are user-configurable to be SIL 2 rated annunciation functions as well. The customer is expected to use appropriate SIL rated device to receive at least one of these signals.

There are three SVI II ESD models available:

- ASD Model - Analog Safety Demand; 2 Wire Analog Trigger, 4 - 20 mA signal, 2 wire installations with HART<sup>®</sup> communications.
- DSD Model - Discrete Safety Demand; 2 Wire Discrete Trigger, 24 VDC, 2 wire installations with HART<sup>®</sup> communications.
- A/DSD Model - Analog Setpoint with Discrete Safety Demand; 4 Wire Discrete Trigger, 4 - 20 mA signal, 2 wire installations with HART<sup>®</sup> communications for control system and 24 VDC 2 wire for Safety System.



## Additional Features

The SVI II ESD acquires actuator pressures, valve position, air supply, and set-point whether the safety function is invoked or not. The SVI II ESD captures and stores data when the safety function is invoked. The result is an automatically saved as a signature in the non-volatile memory.

The SVI II ESD is capable of annunciating faults resulting from a PST or using data acquired from internal diagnostic tests. SVI II ESD internal diagnostics diagnose the following:

- I/P health
- Relay health
- Sensor health (A/D, Temp, Pressure, Air supply, etc.)

Other features:

- Discrete output (SW #1) is de-energized for any fault related to the I/P, relay, or valve/actuation assembly, resulting from a PST or while in normal operation.
- HART<sup>®</sup> communication (HART<sup>®</sup> CMD#48) can be used as the basis for fault communication.
- Blinking alarms on the local display alert users to fault conditions.
- For all fault conditions the ESD device attempts to remain in the energized state unless an ESD command is given. On the *Pneumatics* and *Electronics* tab on the *Status* screen of the ESDVue software you can set whether pneumatics, actuator, or electronics testing fail to a predefined high or low level.

## Physical and Operational Description

SVI II ESD is a smart electro-pneumatic positioner that receives a 4 - 20 mA electrical position setpoint signal from controller and compares it with valve position feedback sensor. The difference between position setpoint and position feedback is analyzed by position control algorithm that sets a servo signal to I/P converter. I/P output pressure is amplified by a pneumatic relay driving the actuator. Once the error between setpoint and the valve position feedback is within range, no further correction is applied to the servo signal in order to maintain valve position.

Local explosion proof LCD/Buttons (if equipped) display provides configuration or calibration capabilities in all operating environments. The limit switch/transmitter options board provides software configurable contact outputs, and analog (4 - 20 mA) position feedback.

SVI II ESD is housed in an industrial, tough, weatherproof, corrosion resistant aluminum housing designed to operate in hazardous areas. Electrical connections are through two 1/2" NPT F conduit entries. Pneumatic connections are through two or three 1/4" NPT F ports.

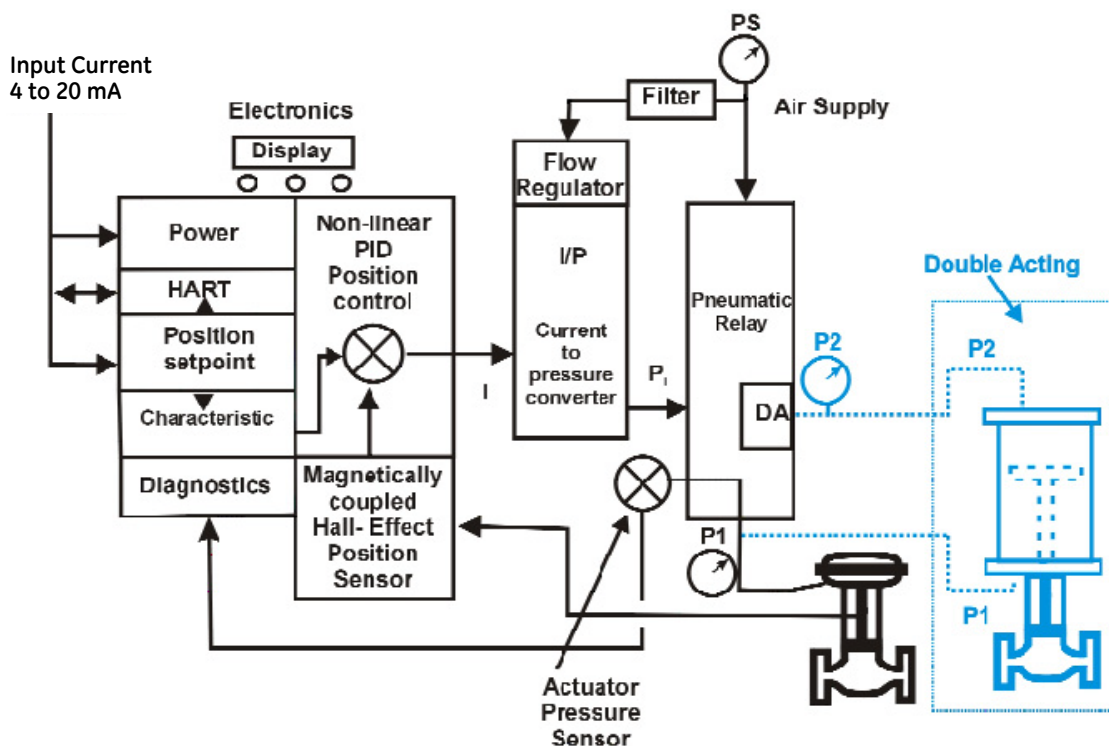

Figure 74 Block Diagram with I/P Converter and Pressure Sensor

## SVI II ESD Components

This section describes SVI II ESD major components and provides a physical and operational description for each one.

### Electronics Module

Electronics module consists of an electronic circuit encapsulated in a housing. Electronics include a multiplexer, A/D, D/A, temperature sensor, Hall-Effect magnetic position sensor, pressure sensors, micro controller, and a power management/distribution circuit. The programs controlling SVI II ESD positioner are stored in a flash memory allowing download of upgraded firmware.

A separate non-volatile memory stores configuration information, and continuous diagnostic results. Expansion capabilities include connectors for addition of optional local display with pushbuttons. Using internal programmed positioner algorithm, the CPU computes required output based upon information received from the measurement sensors. Base module has no user repairable components.

### Magnetic Position Sensor

A non-contact sensor using a magnetic field to transfer position through the wall of the housing, without penetration, senses valve position. A Hall effect device, sealed within the electronics housing, senses rotation of a magnetic assembly mounted on the end of rotary valve shaft or on a driven linkage mounted on reciprocating valve.

The Hall sensor output provides the position feedback signal to the position control algorithm. Magnetic assembly is environmentally sealed and is entirely outside electronics housing. (See Figure 74 on page 130.) Hall effect sensor has a maximum travel range up to 140° rotation.

### Position Retransmit

The position transmission option provides a 4 - 20 mA signal proportional to valve position transmitted on a separate pair of leads. A pair of contacts can signal high and low position limits.

The position sensor also provides, through the electronics module, a readout of valve position on the optional display and communication of valve position via HART<sup>®</sup> protocol.

The 4-20 retransmit is galvanically isolated from the 4-20 input on the main board.

### Pressure Sensor

Pressure sensor located in the Electronics Module measures output from the single acting relay. Pressure measurement is displayed on the local display or read by a HART<sup>®</sup> communication device.

## Temperature Sensor

A temperature sensor is located in electronics module and measures ambient temperature. This measurement provides temperature compensation for the position and pressure sensors and other internal electronic components. Temperature is read via the HART<sup>®</sup> communication link to provide a warning if excessive ambient temperature at the positioner occurs.

## Output Switches

### Introduction

The SVI II ESD supports two identical contact outputs, SW #1 and SW #2 (Digital Output switches), that can be logically linked to status bits.

The switches are polarity sensitive and must be connected only to a DC circuit. The switch (+) terminal must be electrically positive with respect to the (-) terminal. If the (+) terminal is electrically negative with respect to the (-) terminal, then the switch will conduct, regardless of switch state.

**If the switch is connected directly across the power source, the current will be limited only by the capacity of the power source and the switch can be damaged.**

Without a load, when the switch is on (closed) the external voltage would be dropped across the switch. **This damages the switch** (Figure 75).

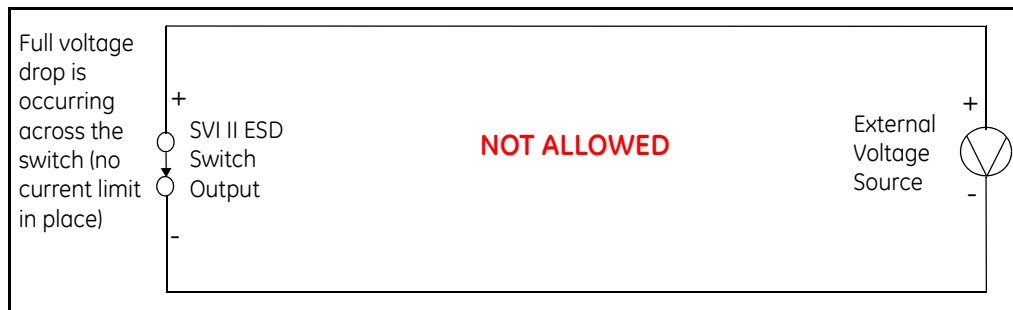

Figure 75 Switch Installation Drawing without Load: **Configuration Not Allowed**

### General Configuration Notes

This section discusses the necessary precautions when configuring a system.

	Switch OFF	Switch ON
$V_{\text{SWITCH}}$	30 VDC max.	$\leq 1$ V (Switch saturation voltage)
$I_{\text{SWITCH}}$	$\leq 0.200$ mA (Switch leakage current)	1 A max.

#### CAUTION



*Incorrect polarity connection results in an effectively closed connection.*

#### CAUTION



*Consult with qualified personnel to ensure that electrical requirements for the switch are met.*

The maximum voltage that can be applied to the digital switch outputs is 30 VDC. This is an open circuit parameter (the digital switch is in the open state). Under open circuit conditions, the switch current will be less than 0.200 mA.

The switch maximum current rating is 1 A. When the switch is ON, the typical switch voltage is  $\leq 1V$ .

When the switch is on (closed) the external voltage must be dropped across the load (Figure 76).

**CAUTION**



*The load must be designed such that the current in the circuit is  $\leq 1 A$  at all times. Some 3rd party devices, such as incandescent lamps or solenoids, require surge and back EMF protection to prevent voltage spikes.*

**Inductive Load, Solenoid, Incandescent Lamp Configuration**

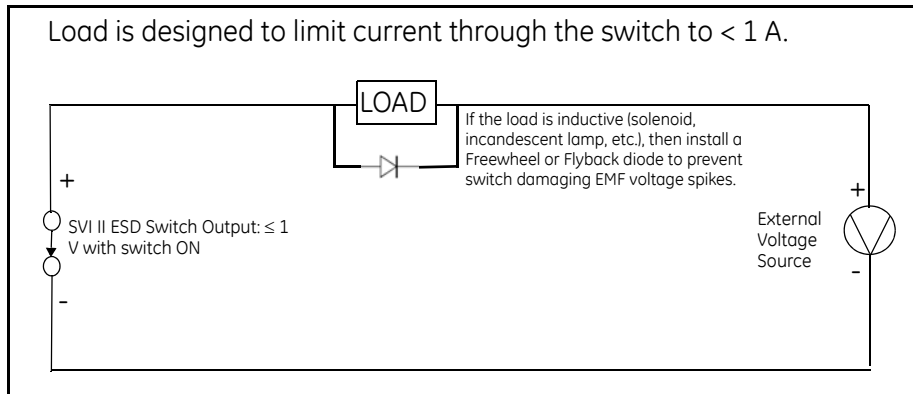

**Figure 76 Switch Installation Drawing: Correct Configuration with Load**

## Distributed Control Systems Configurations

This section gives guidance for configuration in a DCS application. Figure 77 gives two generalized drawings that cover DCS applications to ensure switch safety.

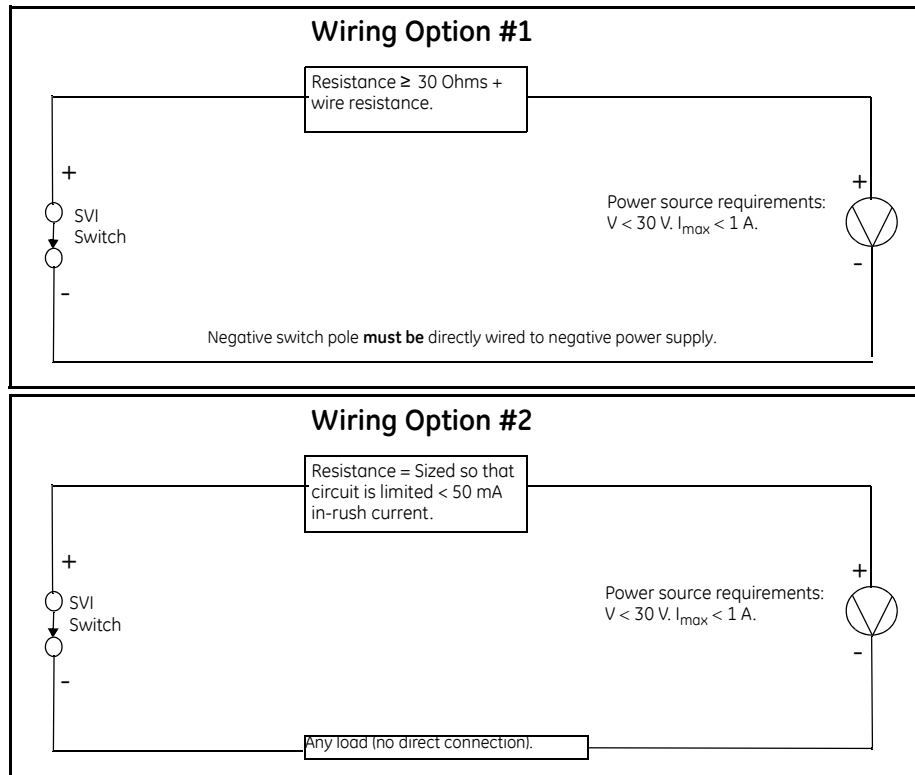

Figure 77 DCS Switches Wiring Options

### Configuration Considerations

- A typical value for 24 AWG cable about 0.025 Ohm/ft (see Wiring Option #1)).
- If IS barrier is a combination of fuse, resistor and Zener diode then the connection is shown in Option #2. The barrier must have adequate resistance to limit inrush current, as the fuse cannot limit inrush current (see Wiring Option #2).

## Switch Settings

The two digital output switches can be opened or closed in response to conditions that the SVI II ESD detects (only one switch is configurable for the ESD). These conditions are:

0. *Always Normal Position* - the switch remains in it's default position. The two digital output switches can be opened or closed in response to detected conditions. The default configuration setting is *Always Normal Position*, where normal is closed, which means that the switch will not switch for any valve travel. To activate the switch at a given valve position, configure the switch *Position Low Limit* or *Position High Limit*.
1. *Failsafe* - the switch is activated when the SVI II ESD is in failsafe mode
2. *Reset* - the switch is activated whenever a reset has occurred and the switch remains activated until the SVI II ESD status is cleared
3. *Position Error* - the switch is activated whenever a position error has occurred and is deactivated when the position recovers to the correct position
4. *Tight Shutoff Active* - the switch is activated whenever the device is in tight shutoff (tight shutoff is on and the valve position is less than the tight shutoff position)
5. *Position Low Limit* - the switch is activated whenever the valve position is less than the position setting of this switch control

### CAUTION



*If both Position Low Limit and Tight Shut Off are used, the Position Low Limit **must** be above the Tight Shut Off.*

6. *Position Upper Limit* - the switch is activated whenever the valve position is greater than the position setting of this switch control.

### CAUTION



*If both Position High Limit and Full Open Above are used, the Position High Limit **must** be below the Full Open Above.*

7. *Manual Mode* - the switch is activated whenever the SVI II ESD is in Manual mode.

### NOTE



*The contacts are OPEN when the SVI II ESD is unpowered and may be configured (via the DTM or DD) to be open or closed when the flag is asserted after boot.*



### Position Transmitter (AO)

The SVI II ESD has the ability to retransmit the position signal as an output to another device with 4 - 20 mA current output proportional to position. Enter a lower range value and an upper range value.

### Pneumatic Module

The pneumatic module consists of an I/P and relay assembly.

### Current-to-Pressure Converter, I/P

The I/P converts a current signal into a pressure signal in the following manner. A fixed coil creates a magnetic field proportional to the applied current. The field magnetically pulls a flexure towards a nozzle to increase pressure on the flexure. The pressure on the flexure increases in response to a coil current increase. Coil encapsulation of the provides protection from environmental pollution.

### Single Acting Pneumatic Relay

The single acting pneumatic relay amplifies the pressure from the I/P and increases airflow as required for stable, responsive, actuator performance. Single acting relay operates on any supply pressure that is at least 5 psi (.345 bar, 34.5 kPa) above the required actuator pressure, up to 100 psi (6.9 bar, 690 kPa).

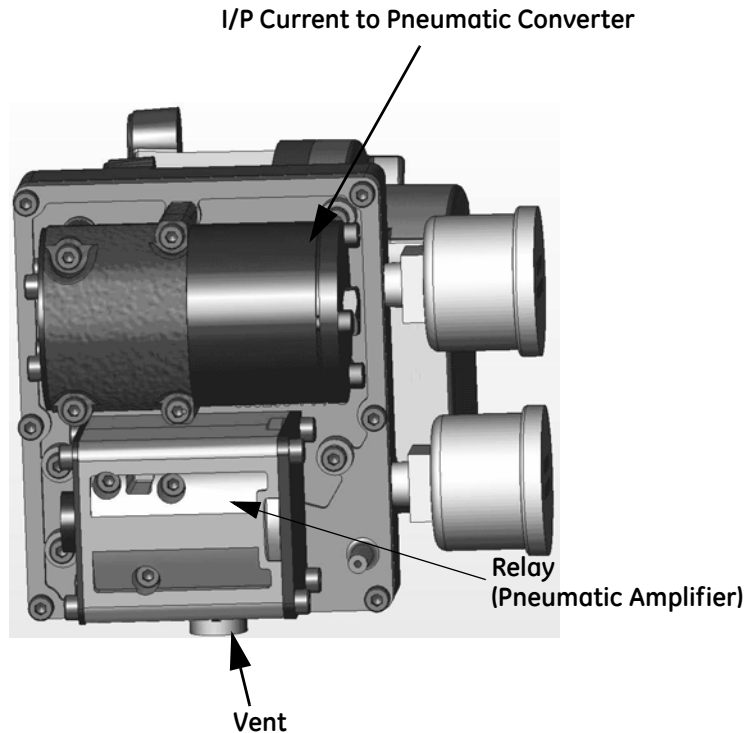

Figure 78 Pneumatic Module with Single Acting Relay

## Optional Display and Pushbuttons

The optional display and buttons are mounted on SVI II ESD cover plate. Three pushbutton switches operating in conjunction with the display permit reading and modification of instrument operating parameters without a PC or HART® handheld communicator. These switches perform generic functions - Increase, Decrease, and Accept - by movement through a conventional menu structure. Switches are operated in a hazardous environment without compromising the flameproof enclosure.

## SVI II ESD Maintenance

### Repair and Replacement

Repairs can be made only by factory authorized personnel trained to repair Safety Devices.

#### WARNING



*When working on safety rated equipment appropriate risk reduction safety measures should be in place.*

- A conservative approach is taken in estimating the service interval for the digital valve controller in Safety Instrumented Systems. For SIS applications, preventive maintenance should be performed on the SVI II ESD five years from date of shipment if the average daily ambient temperature is below 60° C (140° F). For applications where ambient temperature exceeds 60° C (140° F) for extended periods, reduce this maintenance interval based on plant experience.
- SVI II ESD preventive maintenance consists of replacing gaskets, O-rings in the device and a visual inspection of moving components to verify satisfactory condition. Following maintenance, the SVI II ESD must be reinstalled on the valve actuator and calibrated per the procedures in this manual. After calibration, The SVI II ESD functional safety must be validated. All maintenance procedures must be performed only by factory authorized personnel trained to repair Safety Devices.
- Should alarms or alerts be detected during operation, maintenance or periodic inspection and test, immediately take corrective action according to the troubleshooting and repair procedure.

## Factory Notification

Report any failures that are detected and that compromise functional safety to the factory. Sales Office locations are listed on the back cover of this document.



*BHGE does not assume responsibility for the selection, use, or maintenance of any product. Responsibility for proper selection, use of any BHGE product remains solely with the purchaser and end-user. The SVI II ESD requires recertification which must be performed by factory authorized personnel trained to repair Safety Devices.*

## Display Cover Removal and Installation

The cover with display (Figure 79) is standard with the SVI II ESD. If you to replace the display cover, follow the instructions below for removal and installation.

### Tools Needed for Cover Replacement

- 5 mm hex key for the cover
- 3 mm hex key for the lanyard

### Removing the SVI II ESD Display Cover

To remove the SVI II ESD display cover:

1. Using a 5 mm Hex key unscrew the four screws around the perimeter of the SVI II ESD cover and lift the cover off the positioner.



**Figure 79 SVI II ESD Pneumatic and Display Covers**

## Installing the SVI II ESD Display Cover



*After replacing the SVI II ESD Display Cover you must power up the unit (see “Powering Up the SVI II ESD” on page 80).*

The replacement display cover is shipped with a lanyard to prevent the cable (that connects from the display to the Terminal Board) from breaking. The lanyard must be inserted under the screw in the lower left corner, that attaches the terminal board to the SVI II ESD housing.

To Install the cover:

1. Install the lanyard and tighten the screw to 5 in/lb.
2. Using the 3 mm hex key, remove the screw from the lower left corner, connecting the terminal board to the SVI II ESD housing.
3. Connect the cable from the display into the LCD connector on the terminal board.
4. Ensure that the gasket is in its groove in the housing.
5. Place the cover over the screw mounts.
6. Tighten the four screws with the 5 mm hex key.
7. After installing the new display you must power up the unit (refer to “Powering Up the SVI II ESD” on page 80).



*The cover of SVI II ESD is a critical component for safety in Hazardous Areas. To ensure safe operation the flat surfaces of the cover and the housing must be clean and absolutely free of particles or dents. There must be no gap between the housing and cover; torque spec is 50 in/lb.*

Ensure that:

- Gasket is seated in the groove in the housing flange.
- No wires or retaining cable can be trapped under the cover flange.
- Flange area is not corroded and surface is not scarred.
- Four cover bolts are securely tightened to 50 in/lb.

## Upgrading Firmware

SVI II ESD is equipped with a nonvolatile re-writable Flash Memory for program storage. The firmware can be updated as improvements and advances are made in the embedded programs that operate the SVI II ESD. Firmware improvements for SVI II ESD can be obtained by contacting the factory.

### Tools Required

- HART<sup>®</sup> modem
- PC with Windows 2000, XP or later, 16 MB RAM
- ValVue ESD software or later (provided with software upgrade on CD-ROM)

### Installing Firmware Upgrade

It is recommended that configuration is uploaded and saved prior to installation procedure. Follow ValVue ESD instructions to save the old configuration. Follow the detailed instructions included with the software update.

To check firmware version cycle the power off, then on, to perform a cold start. The display shows software version in upper right corner. When maintenance is complete reinstall the positioner and perform checkout procedure detailed in “Installation and Setup” on page 57. Consult factory for firmware upgrade services. ValVue ESD is the recommended tool for complete re-configuration. See “Configuration and Calibration” on page 89.

*This page intentionally left blank.*

# 9. Troubleshooting

## Overview

One of the key features of SVI II ESD is the ability to diagnose and announce any SIS failure. This section provides information describing the SVI II ESD diagnostics and how to use the diagnostic information to troubleshoot the cause of the problem.

## Internal Diagnostics

SVI II ESD performs internal self-diagnostics and hardware checks. When ValVue ESD or HART® Handheld or the local display indicates that there are error messages write them down for troubleshooting.

Diagnostic information is a crucial function of SVI II ESD operation. There are several methods to perform diagnostics and to view diagnostic data. The SVI II ESD has:

- Internal Diagnostics that automatically run every hour
- Partial Stroke Diagnostics that are user configurable through ValVue ESD
- Step, Extended Signature and Terminal Board diagnostics that are available through ValVue ESD only

## FAILSAFE Mode

Several of the internal diagnostics tests put the SVI II ESD into FAILSAFE mode if the errors continue for a preset time. When SVI II ESD goes into FAILSAFE, the valve is driven to its Failsafe position. It remains in that position until the cause of the error is cleared and the instrument is reset.



*The positioner LCD may indicate Failsafe when an alarm condition exists. Use the pushbuttons to view and clear alarms. See "Accessing Diagnostic Information" on page 144.*

Reset is performed in two ways:

- Connect a HART<sup>®</sup> modem and ValVue ESD, and then click the **RESET** button.

or

- Turn the power off and on.

To prevent the valve from moving after reset:

- Put the controller in manual, and set valve position setpoint to Failsafe position 0% if ATO, 100% if ATC.

You can set a special case of FAILSAFE for use on critical loops to force the process to trip if a positioner is unable to control the valve by:

- Setting a *Position Error Band* and a *Position Error Time 2* that forces valve to its failsafe position if position error exceeds the band for a time longer than time 2.

## Accessing Diagnostic Information

Whenever SVI II ESD encounters an error during any operation it is reported. Dependent upon the interface used, the SVI II ESD determines how the error is reported:

- LCD, errors appear on the LCD.
- ESDVue, errors are reported when running diagnostic tests and on the *Status* screen.
- HART<sup>®</sup> handheld device, errors appears to the HART<sup>®</sup> handheld communicator display.



## Error Messages on LCD

To display and clear error messages, you must first identify the error using *VIEW ERR*, correct the fault condition. To view fault codes and messages listed in Table 13 on page 147.

1. Press **+** in *NORMAL* or *MANUAL* mode to move through the options until you reach the *VIEW ERR* menu item.
2. Press **\*** to go to *VIEW ERR* menu.
3. Press **\*** to display the list of status values.
4. Press **+** to move forward through the list in sequence. Press **-** to move back through the list.
5. Press **\*** at any status message to return to the *VIEW ERR* option in your previous mode.
6. Press **+** to move to *Clear ERR*.
7. Press **\*** to clear all messages (recommended) or press **+** to move to the next option.

### Positioner Fault Messages

Table 13 on page 147 lists fault codes and messages that appear on the display. The table also explains the meaning of each message and a possible cause of the fault.

### Return to Normal Operation

Always return the positioner to *NORMAL* operating mode to resume control by input signal. To return to *NORMAL* mode from any menu:

1. Press **+** or **-** repeatedly until *MANUAL* or *NORMAL* appears.
2. If:
  - NORMAL* appears, press **\*** to return to *NORMAL* operating mode.
  - MANUAL* appears, press **\*** to return to *MANUAL* mode menu.
3. Press **+** repeatedly until *-> NORMAL* appears.
4. Press **\*** to return to *NORMAL* mode and normal operation.

#### NOTE



*When entered from NORMAL mode, the valve still responds to changes in set point input signal and displayed values change in accordance with changes in the input signal. When entered from MANUAL mode valve is in locked position.*

## VIEW ERR Diagnostics Messages

Diagnostic messages are viewed with VIEW ERR from the MANUAL mode menu or from NORMAL mode menu. VIEW ERR menu item allows you to read current status information.

To clear error messages:

- Press \* at *CLR ERR* on either *MANUAL* or *NORMAL* mode menus.  
Exiting from the VIEW ERR menu returns to the previous menu.

# Fault Matrix

Table 13 lists and describes faults detected by SVI II ESD. The table also provides information to help determine the fault cause and corrective action.

**Table 13 SVI II ESD Fault Matrix**

Sequence	Byte #	Bit #	FAULT Name	Criticality of Alarm	Auto-matically cleared	Can be cleared/ Persists across resets	Non-Mas-kable/ Annunci-ated	TEXT For DD & ValVue ESD2 English	Probable Cause English	Recommended Action
1	0	0	RESET	3	No	Yes/No	No/No	Reset	Device reboot. The power recovered. Incoming signal was below 2.9mA.	Reset the flag using ValVue ESD or HART® Host.
2	0	1	LOW_POWER	3	Yes, when Input current > 3.25 mA	No/No	No/Yes	Low Power	Device power is below 3.2mA.	Increase mA only if calibration or diagnostics are to be performed.
3	0	2	ACTUATOR	2	Yes if the condition is resolved	Yes/No	No/Yes	Actuator Error	1- Air supply is insufficient. 2- Handwheel or mechanical stop present. 3- Valve stuck or sticking excessively. 4- Unbalance forces on valve trim exceeds actuator capability.	1- Increase air supply above spring final value + 10 psig. 2- Verify if mechanical stop is present. 3- Perform valve signature using ValVue ESD. 4- If possible, perform valve signature under process conditions. Validate sizing of actuator against process condition using ValSpeQ.
4	0	3	AIR_SUPPLY_LOW	2	Yes if the condition is resolved	Yes/No	No/Yes	Air Supply Low	1- Air supply is not turned on or is set below 10psig.	1- Increase air supply above spring final value + 10 psig.

**Table 13 SVI II ESD Fault Matrix (Continued)**

Sequence	Byte #	Bit #	FAULT Name	Criticality of Alarm	Automatically cleared	Can be cleared/Persists across resets	Non-Mas-kable/Annunci-ated	TEXT For DD & ValVue ESD2 English	Probable Cause English	Recommended Action
5	0	4	POSITION_ERROR	2	Yes if the condition is resolved	Yes/No	No/Yes	Position Error	<p>1. PST Controller is slow to follow command signal due to physical valve wear, such as tight packing, stem build-up, throttling surface friction or actuator friction.</p> <p>2. Valve is slow to follow command signal due to large volume actuator.</p> <p>3- Valve will not follow command signal due to insufficient or no air supply.</p> <p>4- Valve does not move because the device's mode is not set to Normal.</p> <p>5-. Valve will not follow command signal due to poor PST controller tuning for current valve status.</p>	<p>1- Perform valve signature using ValVue ESD.</p> <p>2- Perform step test signature using ValVue ESD. Verify that air supply droop during filling is less than 15% or the set pressure.</p> <p>3- Validate that the air supply set to the instrument is greater than the spring final + 10 psig.</p> <p>4- Set the mode to Normal using ValVue ESD or HART® Host.</p> <p>5- Perform Auto-tune or Manual tuning using ValVue ESD or HART® Host.</p>
									<p>6- Valve will not follow command signal due to PST controller malfunction such as I/P or Relay.</p> <p>7- Valve will not follow command signal due to in-line obstruction.</p>	<p>6- Verify if Bias Out Range or I/P Out of Range events are active.</p> <p>7- Perform valve signature using ValVue ESD.</p>
6	0	5	Undefined (reserved)	2	NA	NA/No	No/No	Reserved (0-5)		
7	0	6	KEYPAD FAILED	2		NA/No	Yes/No	Keypad Fault	<p>1- The local push-button and display is defective.</p>	<p>1- Replace the pushbutton and display assembly.</p>

**Table 13 SVI II ESD Fault Matrix (Continued)**

Sequence	Byte #	Bit #	FAULT Name	Criticality of Alarm	Auto-matically cleared	Can be cleared/ Persists across resets	Non-Mas-kable/ Annunci-ated	TEXT For DD & ValVue ESD2 English	Probable Cause English	Recommended Action
8	0	7	MARGINAL_POWER	2		NA/No	No/No	Marginal Power	1- The input current is less than 3.85mA.	1- Increase loop current to 4mA only if calibration and diagnostics are to be performed.
9	1	0	CALIBRATION_FAILED	3	No	Yes/No	No/No	Calibration Failed	1- Calibration of the input sensors was outside the acceptable range when attempting to calibrate.	1- Using precision measuring equipment, perform calibration according to boundary limits of input sensors.
10	1	1	FIND_STOPS_FAILED	3	Yes, if the find stops process completes successfully	Yes/No	No/No	Find Stops Failed	1- When calibrating stops (Zero / Span) the travel sensor moved outside the acceptable limits 2- A procedure timeout occurred due to an extremely large volume of actuator to displace. 3- Valve position could not stabilize when de-energizing or when energizing the actuator.	1- Using ValVue ESD or HART® Host, verify that travel sensor counts is 0 +/- 1000 with the valve closed. For a 90° valve, measured sensor count is done at 50% travel. 2- Using ValVue ESD or HART® Host, perform a Manual Stop calibration. 3- Verify that air supply is adequate. Verify that accessories (boosters, quick-exhausts, etc.) are not creating instability.

**Table 13 SVI II ESD Fault Matrix (Continued)**

Sequence	Byte #	Bit #	FAULT Name	Criticality of Alarm	Automatically cleared	Can be cleared/Persists across resets	Non-Maskable/Annunciated	TEXT For DD & ValVue ESD2 English	Probable Cause English	Recommended Action
11	1	2	AUTOTUNE_FAILED	3	Yes, If the autotune completes successfully	Yes/No	No/No	Auto-tune Failed	1- When performing an Autotune, procedure failed to complete due valve hysteresis beyond 50%. 2- Air supply is insufficient. 3- Air supply droops significantly during actuator filling.	1- Using ValVue ESD or HART® Host, perform an Autotune with an aggressiveness level between 2 and 4. Or manual tune the parameters according to the instruction manual. 2- Increase air supply above spring final value + 10 psig. 3- Perform 5-10% steps and observe air supply gauge on the PST controller.
12	1	3	STD_DIAGNOSTICS_FAILED	3	Yes, If the diagnostics completes successfully	Yes/No	No/No	Std Diagnostics Failed	1- When running a Standard Actuator Signature, the device failed to move the valve between 10% - 90%.	1- Selected speed is too slow. Increase speed for the test by increments of 1. 2 - Insufficient Air supply.
13	1	4	EXT_DIAGNOSTICS_FAILED	3	Yes, If the diagnostics completes successfully	Yes/No	No/No	Ext Diagnostics Failed	1- When running a Extended Actuator Signature, device failed to move the valve between the configured travel.	1- Selected speed is too slow. Increase the speed for the test by increments of 1. 2 - Insufficient Air supply.
14	1	5	OS_ERROR	2	No	Yes/No	Yes/No	Operating System Fault	1- The micro-controller failed an operation.	1- Notify factory at svisupport@ge.com
15	1	6	Undefined (reserved)	1	Yes	Yes/No	No/No	Reserved (1-6)	NA	NOT IMPLEMENTED
16	1	7	Undefined (reserved)	2		NA/No	No/No	Reserved (1-7)	NA	NOT IMPLEMENTED

**Table 13 SVI II ESD Fault Matrix (Continued)**

Sequence	Byte #	Bit #	FAULT Name	Criticality of Alarm	Auto-matically cleared	Can be cleared/Persists across resets	Non-Mas-kable/Annunci-ated	TEXT For DD & ValVue ESD2 English	Probable Cause English	Recommended Action
17	2	0	BIAS_OUT_OF_RANGE	1	No	Yes/No	No/Yes	Bias Out Of Range	The servo signal to the current-to-pressure converter is outside of normal throttling range.	Ensure the positioner is in Normal mode and air supply is sufficient. If it is, the I/P converter may be failing. Replace the positioner.
18	2	1	IP_OUT_OF_RANGE	1	No	Yes/No	Yes/No	I/P Out Of Range	1- The loop current to the internal current-to-pressure converter is outside of normal range.	Ensure the positioner is in Normal mode and air supply is sufficient. If it is, the I/P converter may be failing. Replace the positioner.
19	2	2	TEMPR_OUT_OF_RANGE	2	Yes	Yes/No	No/Yes	Temp. Out Of Range	The board temperature is below -40 °C or above 85 °C.	NOT IMPLEMENTED
20	2	3	FACTORYWRITE	3	NA	NA/NA	No/Yes	Reserved (2-3)	NA	NOT IMPLEMENTED
21	2	4	Undefined (reserved)	3	NA	NA/NA	No/No	Reserved (2-4)	NA	NOT IMPLEMENTED
22	2	5	Undefined (reserved)	3	NA	NA/NA	No/No	Reserved (2-5)	NA	NOT IMPLEMENTED
23	2	6	Undefined (reserved)	3	NA	NA/NA	No/No	Reserved (2-6)	NA	NOT IMPLEMENTED
24	2	7	Undefined (reserved)	3	NA	NA/NA	No/No	Reserved (2-7)	NA	NOT IMPLEMENTED
25	3	0	NVM_CHECKSUM	1	No	No/No	Yes/Yes	NVM Check-sum Error	1- A permanent corruption of the content in non-volatile memory occurred.	1- Remove power to the device for 2 minutes and restart the device. 2- If the failure persist, replace the device.

**Table 13 SVI II ESD Fault Matrix (Continued)**

Sequence	Byte #	Bit #	FAULT Name	Criticality of Alarm	Automatically cleared	Can be cleared/Persists across resets	Non-Mas-kable/Annunci-ated	TEXT For DD & ValVue ESD2 English	Probable Cause English	Recommended Action
26	3	1	RAM_CHECKSUM	2	No	Yes/No	Yes/Yes	RAM Check-sum Error	1- A corruption of the content in volatile memory occurred.	1- Notify factory at svisup-port@BHGE.com.
27	3	2	FW_CHECKSUM	1	No	No/No	Yes/Yes	Flash Check-sum Error	1- Invalid firm-ware checksum due to data corruption.	1- Remove power to the device for 2 minutes and restart it. 2- If the failure persists, Replace device.
28	3	3	STACK	2	No	Yes/No	Yes/Yes	Stack Error	1- A problem with the memory stack occurred.	1- Clear the condition using ValVue ESD or HART® Host.
29	3	4	FACTORYMODE	1	No	Yes/No	Yes/No	Factory Mode Fault	1- Device is in the factory mode. This fault is not normally seen by end users. Investigate as to how Factory Mode was engaged.	1-Clear the condition using HART® Host. Cannot be cleared using ValVue ESD.
30	3	5	NVM_TEST	2	No	Yes/No	Yes/Yes	NVMTest Error	1- A problem occurred when testing non-volatile memory.	1- 1- Clear the condition using ValVue ESD or HART® Host.
31	3	6	LATCH_FSAFE	1	NA	Yes/Yes	No/Yes	Reserved (3-6)	NA	NA
32	3	7	Undefined (reserved)	3	NA	NA/NA	Yes/No	Reserved (3-7)	NA	NA
33	4	0	REF_VOLTAGE	1	No	Yes/No	Yes/No	Ref Voltage Fault	1- A component problem is affecting the circuit board's reference voltage.	1- Replace the device and report problem at svisup-port@BHGE.com.
34	4	1	POSITION_SENSOR	1	No	Yes/No	Yes/No	Position Sensor Fault	1- Electronic hall sensor component and related components failed.	1- Replace device and report problem at svisup-port@BHGE.com.
35	4	2	CURRENT_SENSOR	1	No	Yes/No	Yes/No	Current Sensor Fault	1- Electronic input loop current sensor is damaged.	1- Replace device and report problem at svisup-port@BHGE.com.



**Table 13 SVI II ESD Fault Matrix (Continued)**

Sequence	Byte #	Bit #	FAULT Name	Criticality of Alarm	Auto-matically cleared	Can be cleared/Persists across resets	Non-Mas-kable/Annunci-ated	TEXT For DD & ValVue ESD2 English	Probable Cause English	Recommended Action
36	4	3	TEMPERATURE_SENSOR	1	No	Yes/No	Yes/Yes	Temperature Sensor Fault	1- Electronic temperature sensor is damaged.	1- Replace device and report problem at svisupport@BHGE.com.
37	4	4	2ND_CURRENT_SENSOR	2	No	Yes/No	No/No	Current Sensor Fault Reserved	1- Secondary input current sensor is damaged.	1- Replace device and report problem at svisupport@BHGE.com.
38	4	5	PRESSURE1	1	No	Yes/No	Yes/No	Actuator Pressure 1 Fault	1- Pressure sensor #1 has been overpressurized and damaged. 2- Pressure sensor #1 has failed due to some malfunction.	1- Replace device and report problem at svisupport@BHGE.com.
39	4	6	PRESSURE2	1	No	Yes/No	Yes/No	Actuator Pressure 2 Fault	1- Pressure sensor #2 has been overpressurized and damaged. 2- Pressure sensor #2 has failed due to some malfunction.	1- Replace device and report problem at svisupport@BHGE.com.
40	4	7	PRESSURE3	1	No	Yes/No	Yes/No	Supply Pressure Sensor Fault	1- Pressure sensor #3 has been overpressurized and damaged. 2- Pressure sensor #3 has failed due to some malfunction.	1- Replace device and report problem at svisupport@BHGE.com.
41	5	0	PRESSURE4	1	No	Yes/No	Yes/No	I/P Pressure Sensor Fault	1- Pressure sensor #4 has been overpressurized and damaged. 2- Pressure sensor #4 has failed due to some malfunction.	1- Replace device and report problem at svisupport@BHGE.com.
42	5	1	PRESSURE5	2	No	Yes/No	Yes/Yes	Atmospheric Pressure Sensor Fault	1- A component problem is affecting circuit board's reference voltage.	1- Replace device and report problem at svisupport@BHGE.com.
43	5	2	WATCHDOG_TIMEOUT	2		NA/No	Yes/Yes	Reserved (5-2)	NA	NOT IMPLEMENTED

**Table 13 SVI II ESD Fault Matrix (Continued)**

Sequence	Byte #	Bit #	FAULT Name	Criticality of Alarm	Automatically cleared	Can be cleared/Persists across resets	Non-Mas-kable/Annunci-ated	TEXT For DD & ValVue ESD2 English	Probable Cause English	Recommended Action
44	5	3	NVM_WRITE	2	No	Yes/No	Yes/Yes	NVM Write Fault	1- An error occurred when attempting to write to non-volatile memory.	1- Clear the condition using ValVue ESD or HART® Host. 2- If condition persists, replace device and report problem at svi-support@BHGE.com.
45	5	4	IRQ_FAULT	2	No	Yes/No	Yes/No	IRQ Fault	1- The circuit board interrupt request failed.	1- Clear the condition using ValVue ESD or HART® Host. 2- If condition persists, replace device and report the problem at svisupport@BHGE.com.
46	5	5	TMOUT_-FLASH_TEST	2	NA	NA/NA	Yes/Yes	NA	NA	NOT IMPLEMENTED
47	5	6	SELF_CHECK	1	No	Yes/No	Yes/No	Self Check Error	1-A general self check failed.	1- Clear the condition using ValVue ESD or HART® Host. 2- If condition persists, replace device and report problem at svi-support@BHGE.com.
48	5	7	SOFTWARE	2	No	Yes/No	Yes/Yes	Software Error	Operating system failed in conducting a task.	1- Clear the condition using ValVue ESD or HART® Host. 2- If condition persists, replace device and report problem at svi-support@BHGE.com.
49	6	0	ESD_TRIP (_ACTIVE)	1	Yes	No/No	No/No	ESD Valve Tripped	SVI II ESD successfully de-energized its pneumatic output.	None. This is a status to confirm that SVI II ESD successfully de-energized its output.

**Table 13 SVI II ESD Fault Matrix (Continued)**

Sequence	Byte #	Bit #	FAULT Name	Criticality of Alarm	Auto-matically cleared	Can be cleared/Persists across resets	Non-Mas-kable/Annunci-ated	TEXT For DD & ValVue ESD2 English	Probable Cause English	Recommended Action
50	6	1	ESD_NEW_DATA	3	No	No/Yes	No/No	New ESD Data available	A shutdown event is stored in mem-ory and has not yet been archived by ValVue ESD.	Connect ValVue ESD and wait for flag to self-clear. This will indicate that ValVue ESD successfully archived signa-ture in its data-base.
51	6	2	ESD_DATA_ERROR	3	Yes	Yes/No	No/No	Saving ESD data error	Upon a safety trip (shutdown), a problem occurred when storing event in memory.	1- Clear the condi-tion using ValVue ESD or HART® Host. 2- If condition per-sists, replace device and report problem at svi-sup-port@BHGE.com.
52	6	3	PST_FAILED	1	Yes	Yes/Yes	Yes/Yes	PST Failed	PST could not complete suc-cessfully because of: 1- Problem vent-ing 2- PST pressure value was reached before target travel 3- PST Time value was reached before target travel 4- An ESD event happened during PST.	1- Verify that vent is not clogged up. Verify that there are no Pneumatic Train Integrity Alarm present. 2- Confirm that PST pressure set-ting is not too high. Run an extended signa-ture to confirm proper PST Pres-sure for desired travel target. 3- Verify that vent is not partially clogged or that an accessory is not restricting air exhaust. Increase setting based on PST Travel Rate and PST travel. 4- None
53	6	4	PST_NEW_DATA	3	No	No/Yes	No/No	PST New Data	A PST Test is stored in memory and has not yet been archived by ValVue ESD.	Connect ValVue ESD and wait for the flag to self-clear. This will indicate that Val-Vue ESD success-fully archived signature in its database.

**Table 13 SVI II ESD Fault Matrix (Continued)**

Sequence	Byte #	Bit #	FAULT Name	Criticality of Alarm	Automatically cleared	Can be cleared/Persists across resets	Non-Mas-kable/Annunci-ated	TEXT For DD & ValVue ESD2 English	Probable Cause English	Recommended Action
54	6	5	PST_DATA_ERROR	3	Yes	Yes/No	No/No	Saving PST Error	Upon completion of a PST, a problem occurred when storing event in memory.	1- Clear the condition using ValVue ESD or HART® Host. 2- If condition persists, replace device and report problem at svi-sup-port@BHGE.com.
55	6	6	PNEUMATIC_TRAIN	1	Yes	No/Yes	Yes/Yes	Pneum. Train Integrity	1- The hourly test detected an unhealthy I/P. 2- The hourly test detected an unhealthy pneumatic relay. 3- The hourly test detected a problem in venting.	1,2 Re-run the test from ValVue ESD (Pneumatic Self Test button). If alarm persists contact the factory. 3- Verify vent condition.
56	6	7	TERMINAL_BOARD_DIAG	2	Yes	No/Yes	Yes/Yes	ESD Circuit Integrity	The hourly diagnostic detected a possible problem with the internal shutdown circuit.	Rerun Pneumatic Self Test test. If situation persists, the unit must be replaced.
57	7	0	AI_PV_LOW	2	Yes	Yes/No	No/No	Low PV Analog Input	NA	Not Implemented
58	7	1	AI_PV_HIGH	2	Yes	Yes/No	No/No	High PV Analog Input	NA	Not Implemented
59	7	2	FRICTION_LOW	1	Yes	Yes/Yes	No/Yes	Friction Below Normal	The friction measured from the PST test is below the configured threshold.	1- Verify proper setting of threshold. 2- Valve shaft maybe broken and not engaging the ball / plug.

**Table 13 SVI II ESD Fault Matrix (Continued)**

Sequence	Byte #	Bit #	FAULT Name	Criticality of Alarm	Auto-matically cleared	Can be cleared/ Persists across resets	Non-Mas-kable/ Annunci-ated	TEXT For DD & ValVue ESD2 English	Probable Cause English	Recommended Action
60	7	3	FRICTION_ HIGH	1	Yes	Yes/Yes	No/Yes	Friction Above Normal	1- The friction measured from the PST test is above the configured threshold. 2- The packing can be over-tighten. 3- Possible galling on guiding surfaces.	1- Verify proper setting of threshold. 2- Loosen up packing gland depending on packing type / style and application. Overhaul packing box. 3- Run Extended signature and overhaul valve if condition is validated.
61	7	4	BREAKOUT	1	Yes	Yes/Yes	No/Yes	Break-out Force Exceeded	1- The breakout force measured from a PST test is above configured threshold. 2- The packing gland can be overtighten. 3- Possible galling on guiding surfaces. 4- Possible weakened springs (or broken). 5- Excessive friction between ball and seat.	1- Verify proper setting of threshold. 2-Loosen up packing gland depending on packing type / style and application. Overhaul packing box. 3,4,5- Run Extended signature and overhaul valve if condition is validated.
62	7	5	SUPPLY_ DROOP (Supply deviation)	2	Yes	Yes/Yes	No/Yes	Air Supply Droop Abnormal	1- The air supply droop measured during a PST is above the configured threshold. 2- The filter in air filter/regulator is clogged up. 3- Air supply tubing is too small. 4- Insufficient volume of air supply manifold.	1- Verify proper setting of threshold. 2- Replace filter in the air set. 3- Increase tubing size between air set and SVI II ESD. 4- Re-size manifold.

**Table 13 SVI II ESD Fault Matrix (Continued)**

Sequence	Byte #	Bit #	FAULT Name	Criticality of Alarm	Automatically cleared	Can be cleared/Persists across resets	Non-Maskable/Annunciated	TEXT For DD & ValVue ESD2 English	Probable Cause English	Recommended Action
63	7	6	SUPPLY_LOW	3	Yes	No/Yes	No/No	Low Air Supply Warning	1- An air supply loss occurred. 2- Nearby equipment draws a high volume of air. 3- The air set is adjusted less than the configured threshold.	1- Confirm that operations may be returned to normal, then turn on air supply. 2- Resize air manifold. 3- Increase air pressure to 10psig more than upper spring range and more than 30psig.
64	7	7	SUPPLY_HIGH	3	Yes	No/Yes	No/Yes	High Air Supply Warning	1-A failure in the air filter regulator occurred. 2- A nearby equipment drawing a high volume, suddenly quit using air and created a spike in air supply. 3- The air set is adjusted greater than configured threshold.	1- Replace air filter regulator. 2- Resize air manifold. 3-Adjust threshold to be 3-5 psig greater than set air supply.
65	8	0	IP_CAL_DRIFT	2	No	Yes/No	No/Yes	I/P Calibration Drift Warning	1- The current to pressure converter's flexure has been tampered with or misadjusted. 2- An impending failure is present in the flow regulator of the I/P.	1,2 - Service required. Contact the factory.
66	8	1	IP_SERVO_LOW	1	No	Yes/No	No/Yes	Low I/P Output Pressure	1- The required I/P current is too low to ensure venting of the relay. 2- The I/P flexure is pushed against the nozzle. 3- Faulty I/P flow regulator.	1,2,3 - Service required. Contact the factory.

**Table 13 SVI II ESD Fault Matrix (Continued)**

Sequence	Byte #	Bit #	FAULT Name	Criticality of Alarm	Auto-matically cleared	Can be cleared/ Persists across resets	Non-Mas-kable/ Annunci-ated	TEXT For DD & ValVue ESD2 English	Probable Cause English	Recommended Action
67	8	2	IP_SERVO_HIGH	2	No	Yes/No	No/Yes	High I/P Output Pressure	1- The required I/P current is too high to maintain output pressure to actuator. 2- The I/P flexure is pushed away from the nozzle.	1,2 - Service required. Contact the factory.
68	8	3	LINKAGE_DRIFT	1	Yes	Yes/No	Yes/No	Feed-back Linkage Drift	1-In the fully open or fully closed position a raw travel sensor count deviation of x% exists against the calibrated stop value.	1 - Verify that linkage is well fastened. 2- Re-run the Find Stops method. When device goes in Failsafe when running the Find Stop method, clear alarm and rerun the stops.
69	8	4	VALVE_STUCK_CLOSED	1	Yes	Yes/No	No/Yes	Valve Stuck Closed	1- A handwheel is left engaged. 2- Valve is seized in place. 3- Insufficient actuator thrust.	1- Verify presence of a mechanical stops such as a handwheel. 2- Repair valve. 3- Run a PST or Extended signature. If friction is abnormal then overhaul valve.
70	8	5	VALVE_STUCK_OPENED	1	Yes	Yes/No	No/Yes	Valve Stuck Opened	1- A handwheel is left engaged. 2- Valve is seized in place. 3- Exhaust port is clogged up (no venting). 4- An accessory prevents the air from the actuator to be vented.	1- Verify presence of a mechanical stops such as a handwheel. 2- Repair valve. 3- Verify that exhaust port is not restricted. 4- Run a Pneumatic Self Test test from ValVue ESD. A failure of the Pneumatic Self Test test would indicate a problem in venting.
71	8	6	TMOUT_PST_TEST	1	Yes	Yes/No	Yes/Yes	PST Out of schedule	PST hasn't been performed within time limit.	If persists contact BHGE. Implemented for firmware 3.1.6.

**Table 13 SVI II ESD Fault Matrix (Continued)**

Sequence	Byte #	Bit #	FAULT Name	Criticality of Alarm	Automatically cleared	Can be cleared/Persists across resets	Non-Mas-kable/Annunci-ated	TEXT For DD & ValVue ESD2 English	Probable Cause English	Recommended Action
72	8	7	TMOU_T_PNEU_TEST	2	Yes	Yes/No	Yes/Yes	Pneu-matic test out of sched-ule	Pneumatic test hasn't been per-formed within time limit.	If persists contact BHGE. Implemented for firmware 3.1.6.
73	9	0	LATCH_AIR_LOSS	2	Yes	No/Yes	No/No	Low Sup-ply Pres-sure Latch	Latched due to Low Supply Pres-sure. Supply pressure below configured threshold.	Fix supply pres-sure. Implemented for firmware 3.1.6.
74	9	1	AIR_LATCH_DISABLED	3	No	Yes/No	No/Yes	Air Latch HW Mal-function	Cannot latch due to Low Supply Pressure due to one or more of the position or pressure sensors faults. Airloss Latching disabled due to faulty sensor(s)	If persists contact BHGE. Implemented for firmware 3.1.6.
75	9	2	AIR_LATCH_DELAY	3	Yes	No/Yes	No/Yes	No Rec. Delay Specified	Cannot latch because Air Latch Delay was not set -- would have never recovered if latched. Airloss Latching delay is not entered. Cannot recover.	If persists contact BHGE. Implemented for firmware 3.1.6.



## Troubleshooting with ESDVue

ESDVue provides numerous methods to monitor and troubleshoot SVI II ESD. See the ESDVue help file for specific instructions. Use the:

- Diagnostics screen to run diagnostic tests and review result in both graphical and data formats.
- PST screen for PST diagnostics.
- Status screen to view the current fault status of SVI II ESD operating parameters.
- Check screen to view the current operating parameters of SVI II ESD and to send HART<sup>®</sup> commands and read results.

*This page intentionally left blank.*

# Appendix A. Specifications, References and Return Authorization

## Physical and Operational Specifications

This section provides physical and operational specifications for the SVI II ESD. Specifications are subject to change without notice.

**Table 14 Environmental Specifications**

Operating Temperature Range	-40 °F to 185 ° F (-40 °C to 85 °C)
Storage Temperature Limits	-58 °F to 200 °F (-50 °C to 93 °C)
Temperature Effect	< 0.005% / °F typical; -40 °F to 180 °F (< 0.01% / ° C typical; -40 ° C to 82 °C)
Supply Pressure Effect	0.05% per psi (.73% per bar)
Relative Humidity	10 to 90% non-condensing
Humidity Effect	Less than 0.2% after two days at 104 °F (40 °C), 95% Relative Humidity.
Insulation Resistance	Greater than 10 G Ohms at 50% RH.
MTBF	49 years based on MIL handbook calculation for electronic parts and field data on mechanical parts
Electromagnetic Compatibility Electrostatic	Electrostatic discharge — No effect with contact discharge level of 4KV and air discharge level of 8 KV (IEC 1000-4-2) Radio frequency interference — Less than 0.2% at 10 V per meter (EN 50140)
Fast Transient Burst	No effect at 2 KV (Coupling clamp IEC 1000-4-4).
Vibration Influence Measured at SVI II ESD Housing	4 mm at 5 - 15 Hz - Negligible 2 G at 15 - 150 Hz Less than 2% of span 1 G at 150 - 2000 Hz - Less than 2% of span

**Table 14 Environmental Specifications**

Magnetic Field Influence	Negligible at 30 A/m (EN61000-4-8) CE MARK certified to EN50081-2 and EN50082-2
--------------------------	--

**Table 15 Safety Rated Inputs**

Device	Terminal	Signal	Action	Safety Integrity Level
ASD	4 - 20 mA IN	< 5.6 mA	De-energize to Trip	3
A/DSD	24 VDC IN	< 3 VDC	De-energize to Trip	3
DSD	24 VDC IN	< 3 VDC	De-energize to Trip	3

**Table 16 Operational Specifications**

Accuracy	+/- 0.5% (typical +/- 0.10% or less) Full Span
Hysteresis and Deadband	+/- 0.3% Full Span
Repeatability	+/- 0.3% Full Span
Conformity	+/- 0.5% Full Span
Start-Up Drift	Less than 0.02% in first hour
Long Term Drift	Less than 0.003% per month
Position Travel Limits	Rotary: 18 - 140° Reciprocating: 0.25" - 2.5" (6 mm - 64 mm) <b>Note:</b> Above 2.5" (64 mm) consult factory for mounting instructions.
Position Auto Tune SVI II ESD performs automatic determination of the optimal valve position control parameters. In addition to P, I, D, the position algorithm uses damping, symmetry for exhaust and fill time constants, dead zone and magnitude characterization parameters. Auto Tune is optimized for 5% step changes with negligible overshoot. After Auto Tune process is completed, you can further adjust positioner tuning parameters to more conservative or to more responsive values.	Proportional gain: 0 to 5, displayed as 0 to 5000 Integral time: 0 to 100 s - displayed as 0 to 1000 (1/10 s) Derivative time: 0 to 200 ms Dead Zone: 0 to +/-5% (0 to 10% deadband) Padj: +/- 3000 (depends on P) Beta (non-linear gain factor): -9 to +9 Stroking Time: 0 to 250 seconds Position compensation coefficient: 1 to 20 Boost: 0 to 20
Start Up Time (from no power)	Less than 200 ms
Minimum current to maintain HART <sup>®</sup>	3.0 mA

**Table 16 Operational Specifications (Continued)**

IEC61508 Up to SIL3 per TUV, Type A Device (Simplex, Low Demand), SIL3 Safety Shutdown Function, Safe Failure Fraction with PVST: 99.1%

**Table 17 Input Signal, Power, and Display Specifications**

Signal	4/20 mA with HART <sup>®</sup> Communication Protocol
Power Supply	Taken from 4-20 mA control signal (ASD and A/DSD)
Compliance Voltage Rating	ASD - 9.6 V at 20 mA, 11.0 V at 4.0 mA
	DSD - 24 V at 12 mA
	A/DSD - 9.6 V at 20 mA, 11.0 V at 4.0 mA
Minimum Current Cutoff	3.2 mA
Minimum Terminal Voltage	9.5 VDC @ 20 mA
Current Signal	< 5.6 mA = de-energized output, >15 mA = energized output
ESD in Voltage	0 (trip), 24 VDC energized output
ESD IN current draw	< 9.5 mA
Wire Size	14/28 AWG
Strip Length	0.22 in / 6 mm
Digital Communication	HART <sup>®</sup> Communication protocol signal from ValVue ESD software on a personal computer or a handheld device. HART <sup>®</sup> point-to-point and burst mode.
Local Display Liquid Crystal (optional)	Three lines of nine alpha numeric characters. Display becomes unreadable between 0 °C and -10 °C. Display is shutdown at -15 °C.
Push Buttons	Three Explosion Proof / Flameproof push buttons

**Table 18 Construction Material Specifications**

Housing and Cover	Aluminum ASTM B85 SG100A standard Stainless Steel optional Note: SST version is also SIL3
Weight	Standard - 7.4 lbs./ 3.357 kg Stainless Steel - 16 lbs/ 7.257 kg
Relay and Manifold	Single Acting - PPS, 300 Series Stainless Steel, nitrile diaphragms
I/P Motor	430 stainless steel, PPS, 300 series stainless steel

**Table 18 Construction Material Specifications**

Mounting Bracket	300 series stainless steel
Magnet Holder	Corrosion Protected Anodized Aluminum 6061 T6
Pole Ring	416 stainless steel
Levers	300 Series stainless steel

**Table 19 System Connectivity**

HART <sup>®</sup> Physical Device Type	Actuator; HART <sup>®</sup> device type 7
DD Registered with Field Comm <sup>®</sup>	Yes, available through Field Comm <sup>®</sup>
ValVue ESD Application	
Yokogawa PRM	ValVue ESD Plug-In application available
DD for Handheld	Yes
HART <sup>®</sup> CMD #3	HART <sup>®</sup> 4-20 mA input signal PV = Valve Position, 0-100% SV = Actuator Pressure (P1-P2) TV = Supply Pressure (Not used) QV = P2 for double acting units (not applicable)

**Table 20 Pneumatics Single Acting Standard Flow**

Air Supply	Dry, oil-free, 5 micron filtered air (See ISA S7.3)
Action	Direct
Supply Pressure	30-120 psi max. (2.07 - 8.27 bar, 207 - 827 kPa) Regulated 10 psi above actuator spring range. Do not exceed actuator rating.
Air Delivery - Single Acting Relay	11.48 scf/min. (325 sL/min.) filling, 14.12 scf/min. (400 sL/min.) venting at 30 psi (2.1 bar, 207 kPa) supply 19.25 scf/min. (545 sL/min.) filling, 23.48 scf/min. (665 sL/min.) venting at 60 psi (4.14 bar, 414 kPa) supply 27 scf/min. (765 sL/min.) filling, 32.84 scf/min. (930 sL/min.) venting at 90 psi (6.21 bar, 621 kPa) supply 34.6 scf/min. (980 sL/min.) filling, 42.37 scf/min. (1200 sL/min.) venting at 120 psi (8.28 bar, 828 kPa) supply
Air Capacity (flow coefficient)	Loading CV = 0.57 Venting CV = 0.53

**Table 20 Pneumatics Single Acting Standard Flow (Continued)**

Air Supply	Dry, oil-free, 5 micron filtered air (See ISA S7.3)
Air Consumption	0.212 scf/min. (6 sL/min.) at 30 psi (2.1 bar, 207 kPa) supply 0.282 scf/min. (8 sL/min.) at 60 psi (4.14 bar, 414 kPa) supply 0.424 scf/min. (12 sL/min.) at 90 psi (6.21 bar, 621 kPa) supply 0.529 scf/min. (15 sL/min.) at 120 psi (8.28 bar, 828 kPa) supply
Air Supply Failure	Single Acting Relay On supply failure the actuator output drops. Some overshoot can occur when air pressure returns after a period without air supply pressure. Always set control set point to 0%, and put process control system in manual, for smooth recovery from air supply failure.
Loss of Input Signal	Output drops to low pressure.
Output Pressure	120 psi (8.28 bar, 828 kPa) max
CV	0.59 filling, 0.72 venting
Sweet Natural Gas	H <sub>2</sub> S content not more than 20 ppm

**Table 21 Control Valve Mounting System**

Non-contact Hall Effect Position Sensor (18° to 140° rotation)
Rotary NAMUR Mounting Kit per VDI/VDE 3845
Reciprocating Kits Available

**Table 22 ESD and Diagnostic Capabilities**

Diagnostics	EC61508 compliant up to SIL3 certified by TUV and EXIDA Partial Stroke Testing Initiation (HART <sup>®</sup> , Analog, Local Pushbutton, Built-In Scheduler) Digital Output for PST results and SVI II ESD Health Non-volatile memory for two (2) PST signature Non-volatile memory for ESD Shutdown Event Signature Safety Trip Trigger: 4/20 mA or 24 VDC input Local PST scheduler with built-in calendar Full Stroke Valve Signature & Positioner Diagnostics Built-In Explosion Proof External LCD with Pushbuttons
Language Support	English, Japanese, French, Portuguese, German, Spanish, Italian

**Table 23 Device ID Information**

Manufacturer Name	Masoneilan, Inc.
Manufacturer ID Code	101 (65 Hex)
Model Name	SVI II ESD
Device Type Code	203 (CB Hex)
Device Revision	1
HART Protocol Revision	5
Physical Layers Supported	FSK

**Table 24 Burst Mode Data Return**

Variable	Description	Units/Range
SVI II ESD (firmware 312)		
PV (Primary Variable)	Valve position	0-100%
SV (Secondary Variable)	Actuator Net Pressure	0-150 psig
TV (Tertiary Variable)	Not used (Future)	
QV (Quaternary Variable)	Not used (Future)	



## Models and Applications

Table 25 lists each SVI II ESD model and features.

**Table 25 SVI II ESD Model Features**

Input/Outputs	Model ASD (Analog Safety Demand)	Model DSD (Discrete Safety Demand)	Model A/DSD (Analog Power with Discrete Safety Demand)
Analog In (4/20 mA)	Safety Trip Trigger + HART <sup>®</sup> + Analog PST	-	Device Power + Analog PST + HART <sup>®</sup>
Analog Out (4-20 mA)	Position Transmitter	Position Transmitter	Position Transmitter
ESD In (0-24 VDC)	-	Safety Trip Trigger + HART <sup>®</sup>	
SW #1: 1A, 24 VDC	Not Used	Not Used	Not Used
SW #2: 1A, 24 VDC	Configurable Status	Configurable Status	Configurable Status
DI Switch Input	Unlatch the SVI II ESD <sup>1</sup>	Unlatch the SVI II ESD <sup>1</sup>	Unlatch the SVI II ESD <sup>1</sup>
PV (1-5 VDC)	Read Tight Shutoff Flow <sup>2</sup>	Read Tight Shutoff Flow	Read Tight Shutoff Flow
Local LCD/ Buttons	ESD Status PST Configuration Local PST	ESD Status PST Configuration Local PST	ESD Status PST Configuration Local PST

The SVI II ESD can be installed on linear or rotary actuators.

1. The latching function is software configurable.
2. This variable is sent via HART<sup>®</sup> Command 3 as a Tertiary Variable.

### Hazardous Area Certifications

Listed in the tables below are the SVI II ESD hazardous area certifications.

**Table 26 SVI II ESD Physical Attributes**

Enclosure Rating NEMA 4X / IP 66
Low Copper Aluminum or 316L Housing
Red Electrical Cover and Housing for clear identification as a safety related device

**Table 27 ATEX Approvals**

Intrinsic Safety	Gas: II 1G EEx ia IIC T6 / T5 / T4 Dust: II 1D T96°C
Flameproof	Gas: II 2G EEx dm IIB + H2 T6 / T5 / T4 Dust: II 2D T96 °C
Energy Limited	Gas: II 3G EEx nL IIC T6 / T5 Dust: II 3D T96 °C
Approval Standards	EN50014: 1997, EN50281-1-1, EN60079-26, EN50020, EN60069-15, EN1127-1, EN50018, EN50028

**Table 28 CSA International Certifications**

Explosion Proof	CL I; Div. 1; GR B, C, D T6 / T5 / T4
Dust Ignition Proof	CL II/III; Div. 1; GR E, F, G T6 / T5 / T4
Certified CL II; Div. 2; GR F, G	
Certified CL III; Div. 2	
Certified CL I; Div. 2; GR, B, C, D	
Intrinsically Safe	CL I, II, III; Div. 1; GR A, B, C, D, E, F, G T6 / T5 / T4
Approval Standard	CAN/CSA-C22.2 # 94-M91,142-M198, 157-92, 213-M198, 60529:05

**Table 29 FM Approvals**

Explosion Proof	CL I; Div. 1; GR B, C, D T6 / T5 / T4
Dust Ignition Proof	CL II/III; Div. 1; GR E, F, G T6 / T5 / T4
Suitable for CL II, III; Div. 2; GR F, G	
Non-incendive	CL I; Div. 2; GR A, B, C, D
Intrinsically Safe	CL I, II, III; Div. 1; GR A, B, C, D, E, F, G
Approval Standards	Class 3600, 3615, 3810, ANSI/NEMA 250, IEC 60079-18 IEC60529 +A1

**Table 30 Temperature Class**

T6 = 60°C (160°F), T5 = 75 °C (167°F), T4 = 85°C (185°F)
--

**Table 31 Immunity Performance**

EN61000-4-2, -3, -4, -5, -6, -8
EMC Per IEC61514-2, 61326,61326-3

**Table 32 Radiation Performance**

CISPR 22
----------

## SVI II ESD Models

The model number, on SVI II ESD nameplate is *SVI II ESD-6* followed by seven digits. The seven digits signify the unit configuration. Each digit correlates to a value in the alpha fields shown in Figure 80.

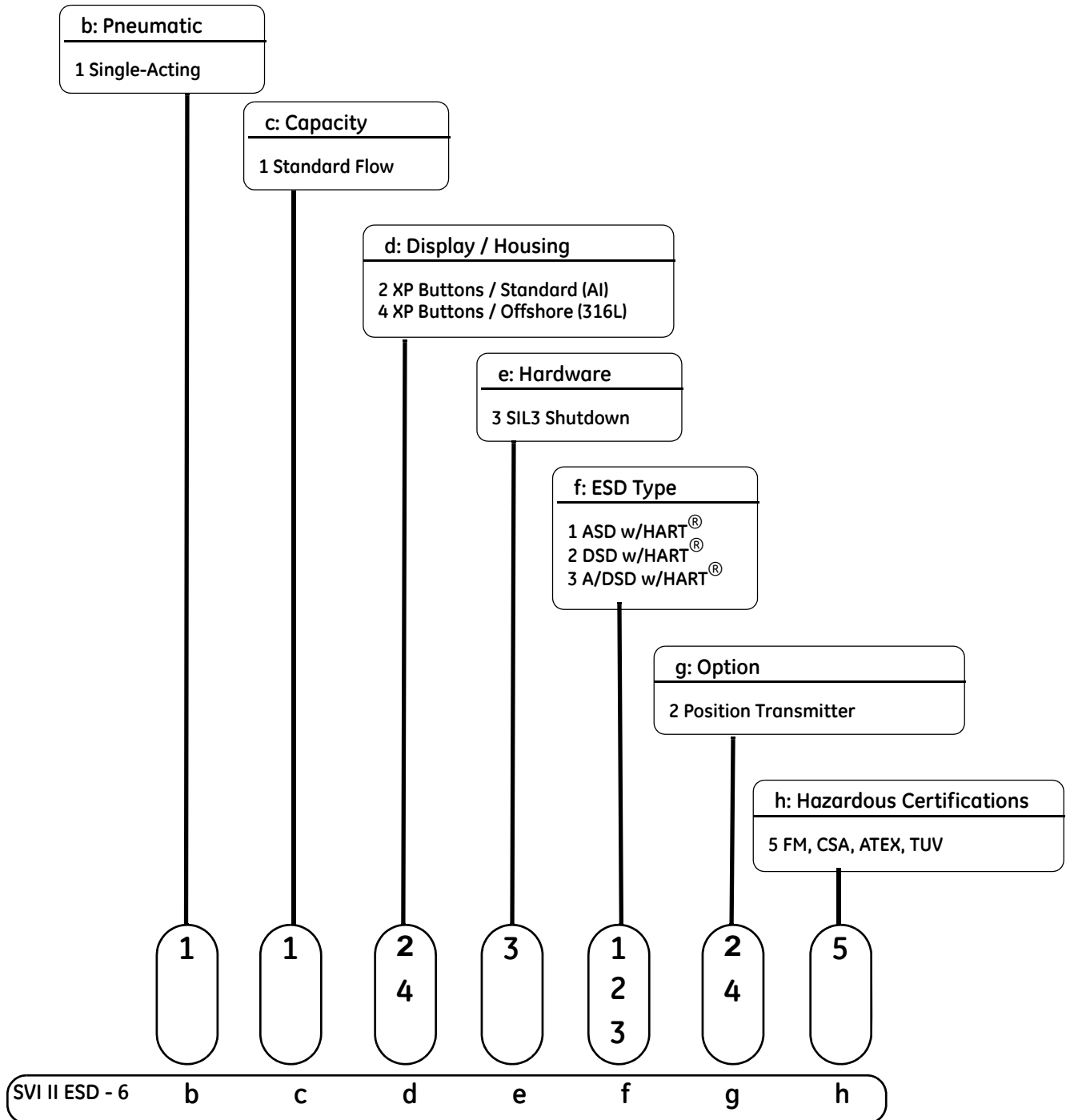

Figure 80 SVI II ESD Model Numbering

# Return Authorization

GE Oil & Gas

Masoneilan Products

<b>Digital Products</b> <b>Material Return Authorization</b>				
<b>Technical Support</b>		Phone Number Email Address	+1 888-784-5463 <a href="mailto:svisupport@bhge.com">svisupport@bhge.com</a>	
<b>MRA Guidelines</b>		<input type="checkbox"/> Complete the following Material Return Authorization Questionnaire. <input type="checkbox"/> Email the form to the SVI Help Desk Representative for an MRA Number. <input type="checkbox"/> Decontaminate the unit and provide an MSDS (Material Safety Data Sheet).		
FIRT #: _____ / MRA #: _____				
<b>Warranty Claimed</b>		YES <input type="checkbox"/>	NO <input type="checkbox"/>	
1	Date:	Authorized By:	Original Sales Order:	
2	Plant of Origin	Jacksonville <input type="checkbox"/>	Deer Park <input type="checkbox"/> Other <input type="checkbox"/>	
3	Product	Other: _____ <input type="checkbox"/>	FVP <input type="checkbox"/> SVI II AP <input type="checkbox"/>	
		SVi1000 <input type="checkbox"/>	SVI II ESD <input type="checkbox"/> SVI FF <input type="checkbox"/>	
4	Part Number:		Serial Number:	
5	With Display <input type="checkbox"/>	Remotely Mounted <input type="checkbox"/>		
6	Dates in Service:		Date of Field Issue:	
7	Actuator	Masoneilan <input type="checkbox"/>	Model      Size	
		Other _____ <input type="checkbox"/>		
8	Spring Range:		Air Supply - Pressure / Dew point:      /	
9	<b>Sales Representative Information</b>		<b>End User Information</b>	
	Sales Rep. Name		Company Name	
	Address		Address	
	Contact		Contact	
	Phone		Phone	
<b>Field Issues</b>				
10	<b>Troubleshooting Guide Complete</b>	<input type="checkbox"/>	Find Stops Failed <input type="checkbox"/>	
	No Communication Go to page 2:	<input type="checkbox"/>	Auto Tune Failed & Manual Tuning Failed <input type="checkbox"/>	
	<del>No Communication using a Handheld</del>	<input type="checkbox"/>	Unstable Output (Cycling) <input type="checkbox"/>	
	No Pneumatic Output	<input type="checkbox"/>	Output Saturated to Supply <input type="checkbox"/>	
	SVI Display Functional	<input type="checkbox"/>	Unit in Failsafe Mode <input type="checkbox"/>	
	Erratic Valve Positioning	<input type="checkbox"/>	Failsafe Fault _____	
11	<b>Additional Information:</b>			
12	<b>Warranty Authorized By:</b>		<b>Estimated Warranty Cost:</b>	
	<b>Authorized By:</b>		<b>Date:</b>	

Details of Field Issue: No Communication

Did not communicate with what?

Handheld

PC running software? What software

DCS running what software? DCS type: \_\_\_\_\_ Software: \_\_\_\_\_

Please send picture of wiring used for communication

FF details:

SVFI FF bus address in physical SVI FF: \_\_\_\_\_ Bus Address for SVI FF in DTM or DCS: \_\_\_\_\_

For Handheld, what type handheld? What is DD version in handheld: \_\_\_\_\_

Was SVI sold on a new control valve built at GE factory? [ ] Yes [ ] No. If Yes:

Name of factory: \_\_\_\_\_

Valve ship date: \_\_\_\_\_

Valve serial number: \_\_\_\_\_ Valve Tag Number: \_\_\_\_\_

Sales Order for control valve: \_\_\_\_\_

Please provide spec sheet for control valve

End user Information on page 1:

Was positioner shipped from GE un-mounted: [ ] Yes Name of GE location that shipped positioner: \_\_\_\_\_

Did rep mount positioner on control valve and ship control valve with SVI2AP? Please provide control valve details as well as date first use for SVI2AP.

SVI2AP date of first use is date when selected from rep stock and mounted on control valve at rep.

Also provide date when control valve was put into service by customer.

Include positioner configuration report from ValVue software. Also include ValVue 2-way 25% step test diagnostic report.

Include installation ambient min/max temperatures when field issue occurred

Include photographs of installation (show entire control valve)

ValSpeQ file for new control valve or ValKeep record for repaired valve.

If SVI is standard diagnostic version, also run manual step test and fill out below "Tested Positioner" table:

Expected - Good Positioner			Tested positioner s/n _____		
mA signal	Valve Position	P1	mA signal	Valve Position	P1
0	open	0	0		
4	open	0	4		
8	25% closed	10	8		
12	50% closed	12	12		
16	75% closed	15	16		
20	100% closed	20	20		
16	75%	15	16		
12	50%	12	12		
8	25% closed	10	8		
4	100% open	0	4		

# Appendix B. Installing an SVI II ESD in a Natural Gas Environment

## WARNING



*The interior of the SVI II ESD is positively pressured with the supply medium. Appropriate safety measures must be taken to handle pressurized natural gas that may enter the electrical conduit or cable system.*

**WARNING: EXPLOSION HAZARD- A missing or improperly installed conduit seal, cable seal or cable gland could leak natural gas into the area around the SVI II ESD install area or into any area where the conduit is present.**

*Ensure natural gas that is vented from the SVI II ESD dissipates quickly. The pneumatic control system constantly bleeds a small amount of the natural gas into the area around the SVI II ESD from the positive pressure vent(s) (see images for bleed vent locations). Also, during an actuator vent cycle (actuator pressure relief), natural gas from the actuator is released into the area around the actuator vent port (see images for actuator vent locations) unless the unit is connected to remote vent gas piping (see "Remote Gas Piping"). Both sources of natural gas (positive pressure bleeding and actuator venting) must be considered when evaluating the Hazardous Classification for the area.*

**WARNING: EXPLOSION HAZARD - Positive pressure venting and actuator venting leak natural gas into the SVI II ESD install area.**

*Do not attempt to collect the gas from the positive pressure bleed vent. Attempting to collect the gas from the positive pressure bleed vent may increase the internal pressure, which could affect performance and compromise the flameproof/explosion proof protection.*

*Ensure all covers and other pressure containing components are correctly installed before putting or returning unit to service.*

**WARNING: EXPLOSION HAZARD- An improperly installed cover or pressure containing component could leak natural gas into the SVI II ESD install area.**

Approximately 0.07 ft<sup>3</sup>/min (2 sLp/min) of natural gas exhausts from the I/P and is vented. For indoor applications, take this into consideration and provide circulation and venting.  
The exhaust points are shown below using red arrows ( → ):





# Remote Actuator Vent Gas Connection

## Remote Gas Piping

Remote vent gas piping must be free flowing to minimize pressure buildup during actuator venting. Pressure buildup inside the vent gas piping can affect performance of the control valve actuation. (Excessive pressure buildup can significantly affect the performance).

Pressure buildup inside the vent gas piping can be minimized by keeping the overall vent gas piping length as short as possible while limiting the number of fittings, elbows, and short radius turns. Keep the vent gas piping diameter large with a minimum (tubing) diameter of 12.7 mm (1/2") for SVI II ESD Single Acting.

In addition to remote vent gas piping, ensure that all components and covers are correctly installed.

## Single Acting Installation

Tools required:

- 9/16 and 1" wrenches
- M3 and M5 Hex Key



Figure 81 Step 1 Remove the Exhaust Cover

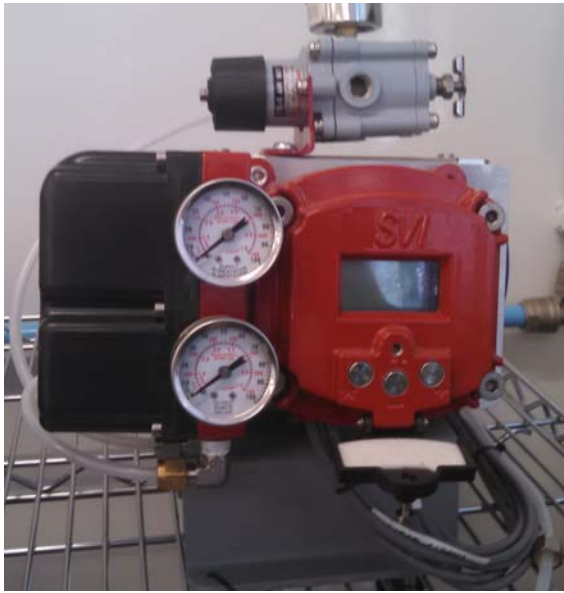

The tubing installed in this step will not capture all gases. Heed the Warnings from the first page.

1. Mount the SVI I ESD to the mounting plate.
2. Connect 1/4" tubing to the gas supply ( **S←** ).
3. Pipe the output from the output pressure port ( **←I** ), to the actuator.
4. Connect a 1/2" tube to the exhaust and route it to:
  - The atmosphere if outside.
  - An outside area, if inside. Do not create back-pressure on the relay. The relay will not function properly with an exhaust pressure higher than atmospheric. Consider the following:
    - a. Minimize the exhaust tubing length and sharp bends (90°) in the tubing.
    - b. Maximize the tubing size; consider stroking speeds if specified.
5. Inspect the electrical conduit connection to ensure a proper seal (conduit gland) is installed.
6. Ensure the covers and other pressure containing components are correctly installed before putting the unit into service.

Figure 82 Step 2 Connect Gas Supply and Exhaust

# Appendix C. HART® Wiring Configurations

## Overview

The SVI II ESD is used as a current loop device drawing power and analog input signal from a precision current source. This section describes wiring configurations using HART® digital communications operating in 4 - 20 mA current mode.

## System Connections

All system connections must comply with the HART® Communications Protocol Specifications. For complete technical information refer to HART® Communications Foundations Document Number HCF-SPEC-11 and references. The SVI II ESD is a HART® compliant device *Actuator* type. It is therefore a 4 - 20 mA receiver, and cannot have a voltage source applied to its input terminals.

When installing the SVI II ESD in a 4 - 20 mA current loop, the engineer designing the loop must consider a set of conflicting electrical requirements. The control signal to the positioner is a 4 - 20 mA current generated by the controller or from the DCS and transmitted to the positioner located remotely in the field. The electrical characteristics of a current loop sending a signal to the field device are different from the apparently similar loop bringing a signal to a controller from a transmitter in the field.

The positioner receives its power from the current signal. It receives its control setpoint from the value of the current and must be able to communicate bi-directionally by superimposing signal tones upon the current signal without distorting the current signal itself. Tones are unaffected by the electrical characteristics of the current signaling device. All these conflicting requirements must comply with equipment manufactured by different manufacturers, and working long cables, in a noisy hostile plant environment. Energy levels are often limited for safe installation in explosive environments. Special engineering may be required to meet signaling requirements at low energy levels in such an environment.

The following does not cover all cases. That is beyond the scope of this instruction manual. It suffices to explain the requirements as a guideline to obtain necessary components from many sources for a successful installation.

**WARNING**



*Do not connect a HART<sup>®</sup> modem and PC to a control circuit unless the controller is HART<sup>®</sup> compatible or has a HART<sup>®</sup> filter. Loss of control or a process upset can occur if the controller output circuit is not compatible with HART<sup>®</sup> signals.*

*Install the SVI II ESD in compliance with Hazardous Area rules in accordance with local electrical codes and plant standards. Use trained specialists for installation.*

*Do not connect a PC or HART<sup>®</sup> modem to an intrinsically safe circuit except on the safe area side before the barrier. Do not operate a PC in a hazardous area if not in compliance with local and plant regulations.*

*A control circuit must be HART<sup>®</sup> compatible or have a HART<sup>®</sup> filter installed. Contact controller or DCS manufacturers. See "HART<sup>®</sup> Filter Requirements" on page 199.*

*Comply with current national and local regulations for electrical installation work.*

*Comply with national and local explosive atmosphere regulations.*

*Before carrying out any work on the device, power off the instrument or make sure that locale conditions for potentially explosive atmosphere permit the safe opening of the cover.*

## HART<sup>®</sup> Wiring Guidelines

The following list contains eight guidelines for a successful implementation of DC current signal, DC power, and HART<sup>®</sup> communication to the SVI II ESD:

- Compliance voltage at the SVI II ESD must be 9 V at the maximum current of 20 mA. See “Determining an SVI Positioner Compliance Voltage in a Control System” on page 219.
- Signal to the SVI II ESD must be a well-regulated current in the range of 3.8 to 22 mA.
- Controller output circuit must be unaffected by the HART<sup>®</sup> tones which are in the frequency range between 1200 and 2200 Hz.
- Frequency range of the HART<sup>®</sup> tones must have a circuit impedance of more than 220 Ohms, typically 250 Ohms.
- HART<sup>®</sup> tones can be imposed by the positioner to a communication device located anywhere on the signaling circuit.
- Capacitance of the signaling circuit can not exceed about 0.26 microfarads or with high series resistance 0.10 microfarads.
- Cabling must be shielded to prevent electrical noise that would interfere with HART<sup>®</sup> tones, with grounded shield at only one location.
- Position Retransmit: when wiring this feature:
  - Wire using the same gauge wire as for the 4-20 mA control loop.
  - In general, ensure that it is connected to the control system’s analog systems card.
  - Ensure the control loop is powered when using a meter to make any measurements.

### NOTE



*For details and calculation methods for wiring resistance, and capacitance and for calculation of cable characteristics refer to the HART<sup>®</sup> FSK Physical Layer Specification.*

## SVI II ESD Setups

Control systems using Explosion Proof or Conventional I/O Systems must have a compliance voltage greater than 9 V at 20 mA.

Control systems using Intrinsic Safety methods must have a compliance voltage greater than 17.64 V.

For General Purpose and Explosion Proof (EEx d) Installation Schematic see Figure 83 on page 181. For intrinsically safe installation schematic see Figure 84 on page 182. The SVI II ESD positioner can be located in a general-purpose or hazardous area protected by Explosion Proof (EEx d) methods. Wiring diagrams are generalized, actual wiring must adhere to Electrical Installation section of manual and local electrical codes. The use of a Hand-held Communicator or a HART<sup>®</sup> modem is not permitted in the Hazardous Area protected by Explosion Proof (EEx d) methods. In Figure 84 on page 182 the SVI II ESD positioner is located in a hazardous area protected by Intrinsically Safe wiring practices.

The SVI II ESD requires an electrical input from a 4 - 20 mA current source. SVI II ESD's input signal can carry a HART<sup>®</sup> communication protocol signal from ValVue ESD or other software and a HART<sup>®</sup> modem, or from a HART<sup>®</sup> Hand-held Communicator. Since the source of the input signal from the process control system is located in a non-hazardous location, setup requires an intrinsic safety barrier be placed between the process control system and the SVI II ESD. If the SVI II ESD is located in a hazardous area with Intrinsically Safe protection a barrier is not required for a flameproof installation. Alternatively the system can be installed as Explosion Proof/flameproof.

The SVI II ESD can communicate with a remote PC running ValVue ESD software via a dedicated HART<sup>®</sup> modem connected to PC's serial port. The PC, which is not intrinsically safe, must be connected to the circuit on the safe area side of the intrinsic safety barrier when the valve is located in a hazardous area.

The SVI II ESD can be operated, calibrated, configured either by using local pushbutton and display, using a remote PC running ValVue ESD software or with the HART<sup>®</sup> Hand-held Communicator. The HHC475 HART<sup>®</sup> Hand-held Communicator is approved for Intrinsically Safe use in accordance with FM, CSA, and ATEX standards. Read and observe all HHC labeling. The SVI II ESD is polarity sensitive so that the positive lead must be connected to the positive (+) terminal and the negative lead must be connected to the negative (-) terminal. *Reversing polarity will not cause damage but the unit will not function properly.*

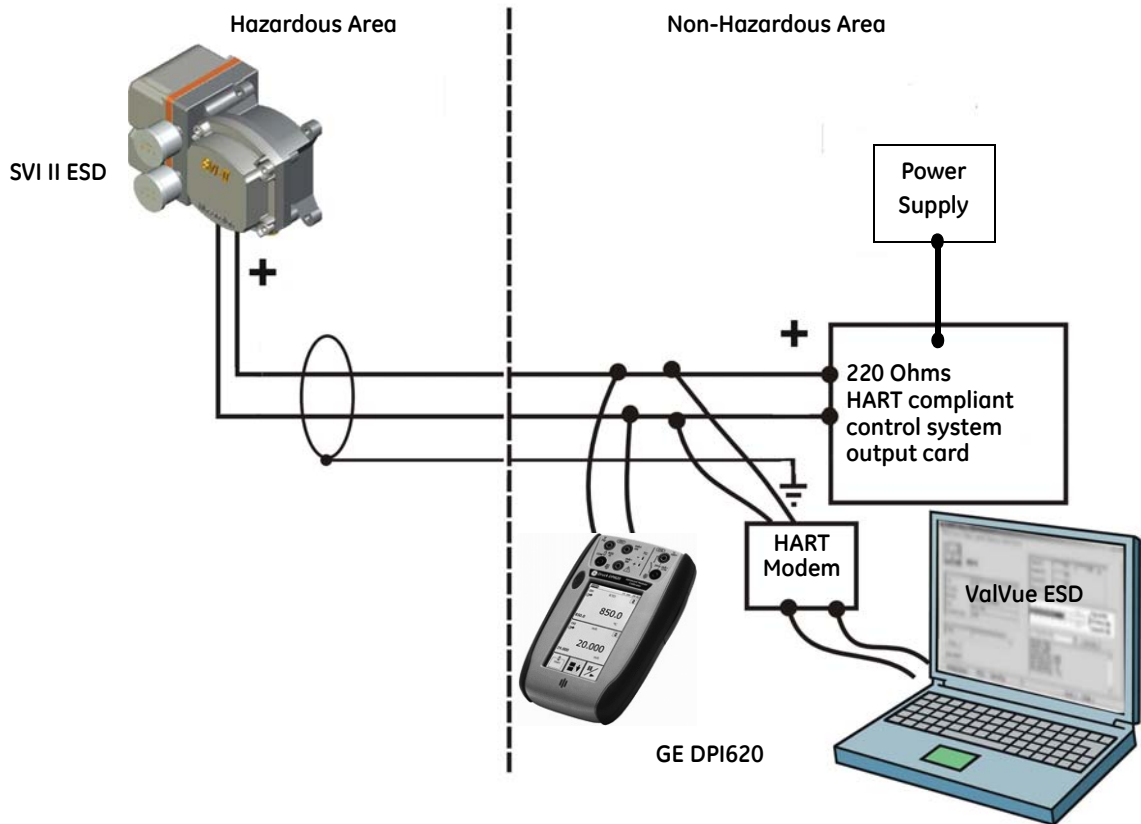

Figure 83 General Purpose and Explosion Proof Installation

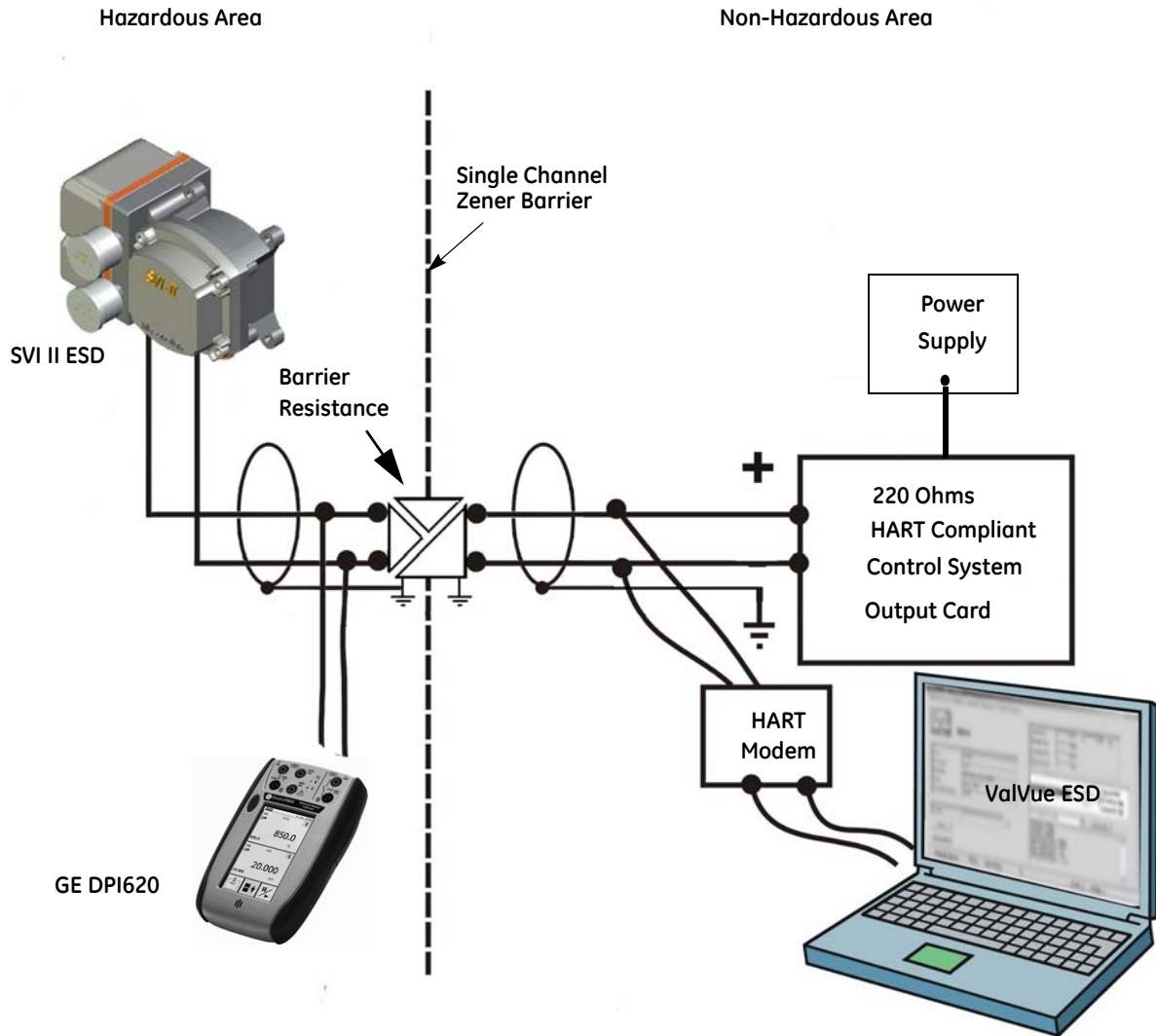

Figure 84 Intrinsically Safe Installation

## Grounding Practices

There must never be more than one ground point for the shield of the signal wiring. Normally ground is connected at the controller or at the intrinsic safety barrier.

The case grounding screws are located outside of the case, at the lower right corner of the display cover and inside the cover. The case is isolated from all circuitry and can be grounded locally in accordance with applicable codes.

Whenever after wiring or grounding, noise or instability is present, set the positioner to MANUAL mode of operation and manually position the valve over its entire range. If the valve is stable in MANUAL mode then the problem can be noise in the control system. Recheck all wiring connections and ground points.



## Compliance Voltage in Single Drop Current Mode

SVI II ESD requires 9.0 V at 20 mA and 11.0 V at 4 mA. Typical smart devices require MORE Voltage at higher current. The controller supplying the current has LESS voltage available at higher current. SVI II ESD is unique in that it requires LESS voltage at higher current, which compliments the characteristic of the source requiring only 9 V at 20 mA.

### CAUTION



*Improperly or inadequately grounded installations can cause noise or instability in the control loop. The internal electronics are isolated from ground. Grounding the case is unnecessary for functional purposes but grounding the case may be necessary to conform to local codes.*

Table 33 through Table 35 provide examples of several SVI II ESD installations and compliance voltage calculation necessary to supply 9 V at 20 mA.

**Table 33 Compliance Voltage for Single Channel Zener with 22 AWG Cable Installation**

Voltage at SVI II ESD at 20 mA	9.0 V
Drop in single channel Zener barrier with 342 Ohms end to end resistance	6.84 V
Drop in 22 AWG cable, 3000' long (30 Ohms per 1000')	1.8 V
Drop in passive HART <sup>®</sup> Filter <sup>1</sup>	0.0 V
Voltage required at controller	17.64 V

<sup>1</sup> Such as MTL HCU16AO

*Conclusion:* Control system must have a compliance voltage equal to or greater than 17.64 V; contact the DCS vendor to verify compliance.

**Table 34 Compliance Voltage for Galvanic Isolator with 22 AWG Cable Installation**

Voltage at SVI II ESD at 20 mA	9.0 V
Drop in 22 AWG cable, 3000' long (30 Ohms per 1000')	1.8 V
Required voltage at Isolator	10.8 V
Voltage available from isolator rated to drive 22 mA into 700 Ohms	13.2 V
Voltage required at controller	Not applicable - Isolator supplies the power

*Conclusion:* Compliance voltage is not an issue because the isolator provides all the necessary voltage.

**Table 35 Compliance Voltage for No Barrier with HART<sup>®</sup> Filter and Resistor and 18 AWG Cable**

Voltage at SVI II ESD at 20 mA	9.0 V
Drop in 220 Ohm resistor	4.4 V
Drop in 18 AWG cable, 6000' long (12 Ohms per 1000')	0.6 V
Drop in passive HART Filter	2.3 V
Voltage required at controller	16.3 V

*Conclusion:* The control system must have a compliance voltage equal to or greater than 16.3 V; contact the DCS vendor to verify compliance.

### Wire Size and Conduit

Electrical connections are made to the electronics module terminal board as shown in Figure 26 on page 43 through Figure 28 on page 44 (based upon SVI II ESD model). Terminals accept wire sizes up to AWG 14. The SVI II ESD is supplied with two 1/2" NPT conduit entries. M20 adapters are available. Internal and external ground terminals are provided for use if grounding is required.

**NOTE**



*When an intrinsic safety barrier separates the SVI II ESD from the modem or HHC a HART<sup>®</sup> compliant barrier must be used.*

# HART<sup>®</sup> Physical Layer Compliance of the Control System

Communicating with an SVI II ESD requires a HART<sup>®</sup>-compliant communications loop. The HART<sup>®</sup> protocol specifies the noise level, impedance requirements, and configuration of the loop. The controller or output card of the control system must comply with the Physical Layer Specification.

## Impedance Constraints

HART<sup>®</sup> communication is based upon the *talking* device generating an AC current superimposed on the 4 - 20 mA control signal. Two frequencies are generated; 1200 Hz representing the digital value *1* and 2200 Hz representing the digital value *0*. The *listening* device responds to the voltage generated when the AC current flows through the loop impedance. In order to generate a voltage from a current there must be impedance. HART<sup>®</sup> Protocol requires that this impedance has to be at least 220 Ohms at the tone signaling frequencies.

HART<sup>®</sup> compliant current sources are supplied with the correct Impedance Versus Frequency Characteristic. In Non-Compliant Current Sources there may be a noise reduction capacitor across the output that lowers the impedance at higher frequencies and thus lowers the signaling voltage. To be certain that an impedance of at least 220 Ohms is presented by the current source a resistor can be added in series with the current source. This reduces the effective compliance voltage of the current source by 20 mA times the value of the series resistor. An added resistor is unnecessary during tests with high impedance current calibrators such as the Altek Loop Calibrator.

## Noise Constraints

HART<sup>®</sup> Communication depends on converting two frequencies (1200 and 2200 Hz) into digital values *1* and *0*. Noise can cause errors in the conversion. Conventional good wiring practice, such as use of twisted shielded pair cable with shield grounded at only one point, minimizes noise effects.

## Cabling and Interconnection Requirements

Interconnections are made using shielded twisted pair cables. Shield is connected to ground at one point only. It is customary to ground the shield at the controller or intrinsic safety barrier. SVI II ESD is supplied with two 1/2" NPT conduit entries. M20 adapters are available. Internal and external ground terminals are provided for case grounding requirements.

### WARNING



*Install the SVI II ESD in accordance with local and national code in both general and hazardous area locations. Substitution of components can impair suitability for use in hazardous locations.*

### NOTE



*The internal electronic components are isolated for ground. Grounding the case is unnecessary for functional purposes. Grounding the case may be necessary to conform to local codes.*

## Capacitance vs. Length of Cable for HART®

The HART® Communications Foundations specifies cable capacitance requirements to preserve signal strength. Refer to standards for detailed calculation methods.

### CAUTION



*Do not connect a HART® modem and a PC to a control circuit unless the controller is HART® compatible or has a HART® filter. Loss of control or a process upset can occur if the controller output circuit is not compatible with HART® signals.*

## HART® Filter Required for Certain Control System Output Circuits

The SVI II ESD is intended for use with all control systems. However, output circuits of several major DCS systems are incompatible with the tones used for HART® signals. You must verify that DCS or controller works reliably with HART® protocol. When the DCS is incompatible an external HART® filter must be installed between the field wiring and the output card, such as MTL manufactured HART® filter HCU16AO model. It is a 16 channel DIN rail mounted device composed of passive circuitry that introduces negligible voltage drop. For additional information, contact MTL.

### NOTE



*A control circuit must be HART® compatible or have a HART® filter installed. Contact the manufacturer of the controller or DCS. See "HART® Filter Requirements" on page 199. of this manual for more information.*

## Split Range Applications

SVI II ESD is designed to operate in split range configurations supporting up to three control valves connected to a single controller output. Minimum input current span for each SVI II ESD is 5 mA. For each positioner the upper range value is between 8 and 20 mA and the lower range value is between 4 and 14 mA. For example, three devices might be configured with input current ranges of 4 - 9 mA; 9 - 14 mA, and 14 - 20 mA. Split range operation with SVI II ESD requires special consideration of the compliance voltage. The SVI II ESD requires at least 9.0 V. Two SVI II ESD in series requires at least 18.0 V in addition to the voltage drops in wiring and other series devices. Typical controller output current sources rarely deliver 24 V, so the system can become voltage starved. It is possible to boost the compliance voltage of the DCS using a series wired voltage source power supply, as shown in Figure 89 on page 193. The total loop voltage must not exceed the rating for the controller output current source. The DCS vendor should be contacted to validate this approach.



*The internal electronic components are isolated from ground. Grounding the case is unnecessary for functional purposes. Grounding the case may be necessary to conform to local codes.*

### Setting Loop Addresses for Split Range Systems

When more than one positioner is installed in a single current loop, the HART<sup>®</sup> loop address of each device must be set to 1, 2, or 3 (or other non-zero values) to allow a HART<sup>®</sup> master to recognize each of the three SVI II ESD devices on the single loop. Do not use 0 for any of the positioners. A 0 can cause HART<sup>®</sup> masters to stop searching for additional positioners.

Both ValVue ESD software or HART<sup>®</sup> Communicator 475 can be used to set non-zero addresses. ValVue ESD must be configured to allow *multidrop* mode, by selecting the *Set Options* function. This function is selected in the *Tools* menu on the *Connected Devices* screen as shown in Figure 85 on page 188 or by right clicking on the *Connected Devices* screen as shown in Figure 86 on page 188. The *Connected Devices* screen is the first screen that appears after successful login to ValVue ESD.

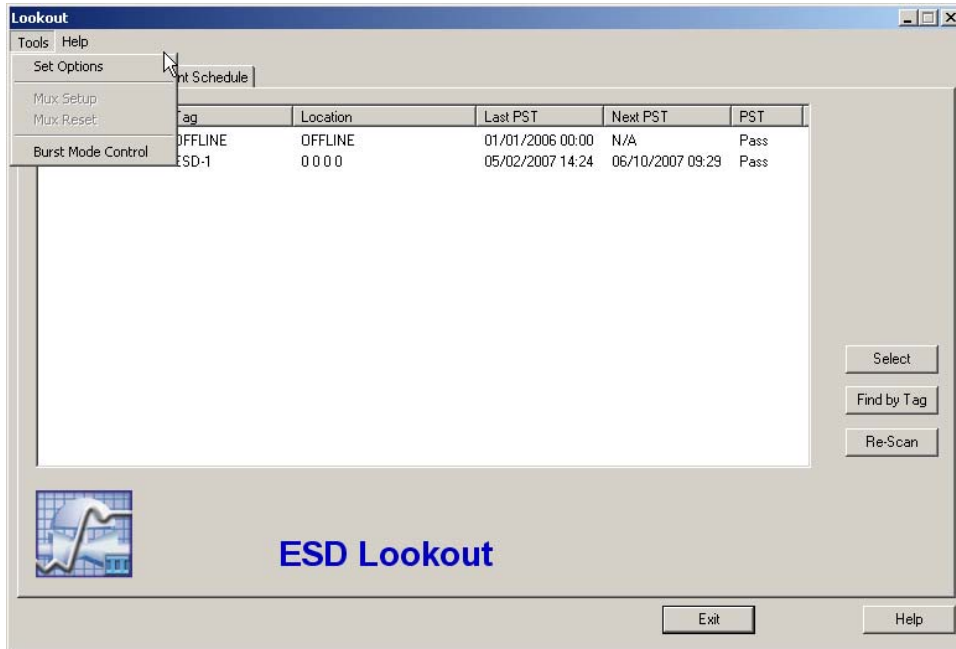

Figure 85 Selecting Set Options - Tools Menu on Connected Devices Screen

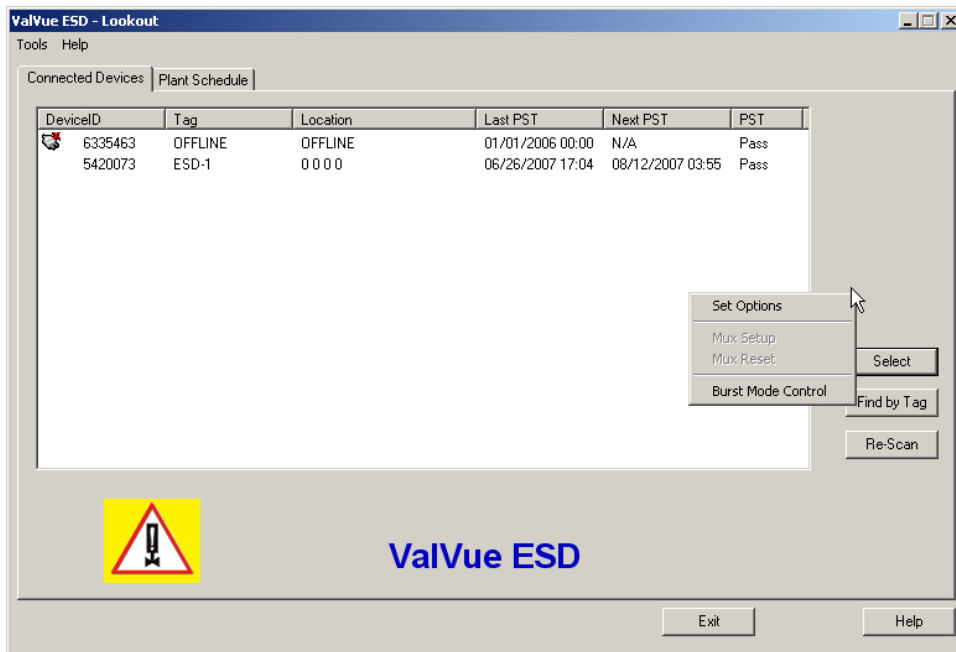

Figure 86 Selecting Set Options - Right Click on Connected Devices Screen

## Multiple Output Circuit Control System

ValVue ESD supports HART® devices including, the SVI II ESD with non-zero polling addresses and multiple SVI II ESDs on the same loop, for split ranging purposes.

To enable split ranging support through ValVue ESD the *Multidrop* function must be activated. Activate multidrop on the *Options* screen, by clicking **Allow Multidrop** (Figure 87). If unchecked, ValVue ESD looks for devices only at polling address 0. When in multidrop mode, even if a device is found at polling address 0, other polling addresses are searched.

DCS systems offer multiple independent analog outputs driven by the same control signal to solve the voltage problem with split ranged positioners. Use of such systems is recommended for split range applications. The HART® address of each SVI II ESD is 0.

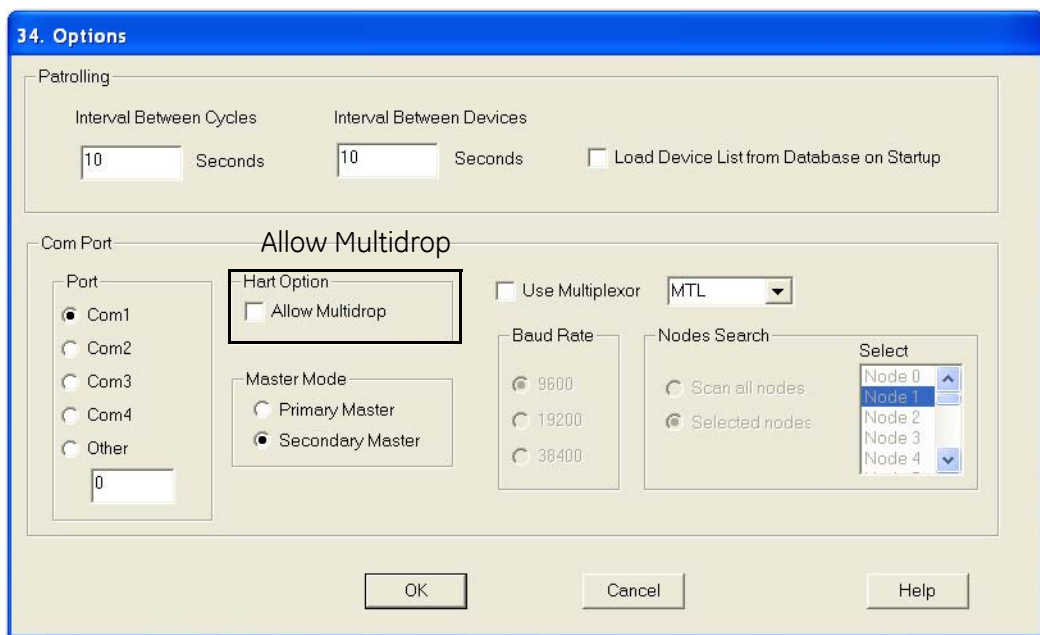

Figure 87 ValVue ESD Setup Options for Multidrop

## Isolators

Another split range solution is achieved by means of an Intrinsic Safety Isolator for each loop as shown in Figure 88 on page 191. Several manufacturers supply suitable isolators designed for use with HART<sup>®</sup> output circuits. Using an IS Isolator allows up to three SVI II ESDs to operate from a single 4 - 20 mA DCS output. Each isolator has a low compliance voltage input requirement and a high voltage output capacity.

Up to three isolators can be connected in series to a single controller output and each of them can drive a positioner. Isolators are used to provide compliance voltage and isolation even in installations not requiring intrinsic safety. Consult the manufacturer for detailed installation instructions.

The HART<sup>®</sup> loop address of each device must be set to 1, 2, and 3 (or any non-zero values) to allow a HART<sup>®</sup> master to recognize each SVI II ESD when connected to all three devices on the safe area side of the multiple isolators. Do not use 0 for any of the positioners. A 0 causes HART<sup>®</sup> masters to stop searching for additional positioners.



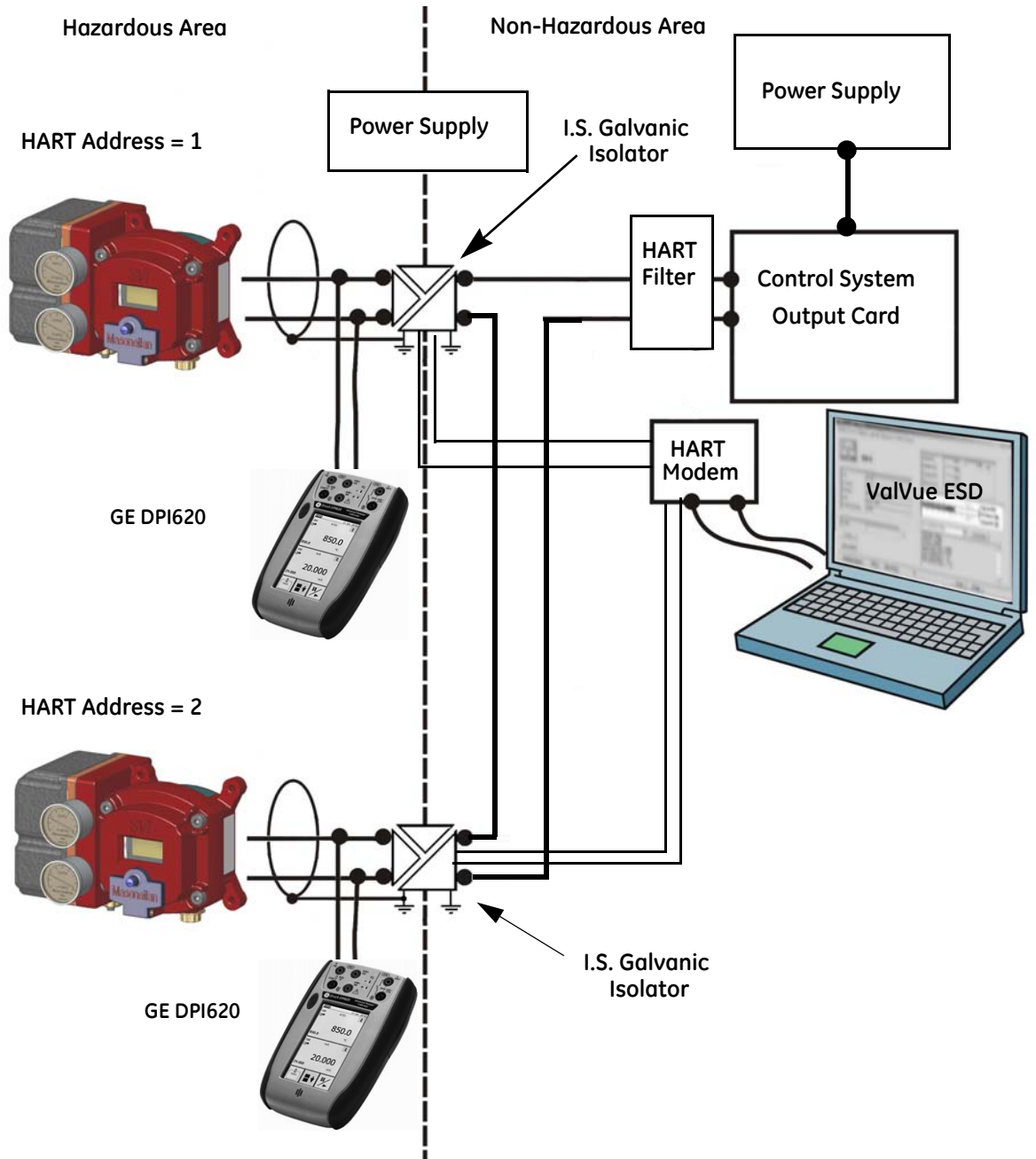

Figure 88 Split Range with Isolator

## Supplemental Power Supply

An alternative approach is to boost DCS compliance voltage using a supplemental power supply (see Figure 89 on page 193) with split ranged SVI II ESD positioners connected in series with the supply. It is not recommended to use supplemental supplies when Intrinsic Safety is required. Barriers do not permit adequate voltage. Contact the DCS vendor to verify that the output circuit is compatible with added voltage. Supplemental voltage must equal 9.0 V for each additional SVI II ESD. Exceeding values stated in Table 36 causes damage if signal wires are short-circuited.

**Table 36 Supplemental Voltage for Split Range**

Number of SVI II ESDs on a Current Loop	Maximum Allowable Supplemental Voltage
1	0
2	9.0 VDC
3	18.0 VDC

## Verify Wiring and Connections

For split range installations some additional constraints have to be considered: the minimum span must be 5 mA; the upper range value must be from 8 to 20 mA; the lower range values must be from 4 to 14 mA. See "HART® Wiring Configurations" on page 177.

Use the following procedure to ensure that SVI II ESD split range system is properly powered:

1. Connect a DC voltmeter across the input terminals.  
For input current value between 4 and 20 mA, the voltage varies between 11 V and 9 V respective.
2. Read current from the local display or with a milliammeter installed in series with the SVI II ESD.  
When voltage exceeds 11 V check that polarity is correct.  
If voltage is less than 9 V and polarity is correct, voltage compliance of current source is inadequate.
3. Connect a milliammeter in series with current signal. Verify that source can supply 20 mA to SVI II ESD input.  
If 20 mA is not attainable, troubleshoot the source and set up.



*Improperly or inadequately grounded installations can cause noise or instability in the control loop. The internal electronic components are isolated from ground. Grounding the case is unnecessary for functional purposes but grounding the case may be necessary to conform to local codes.*

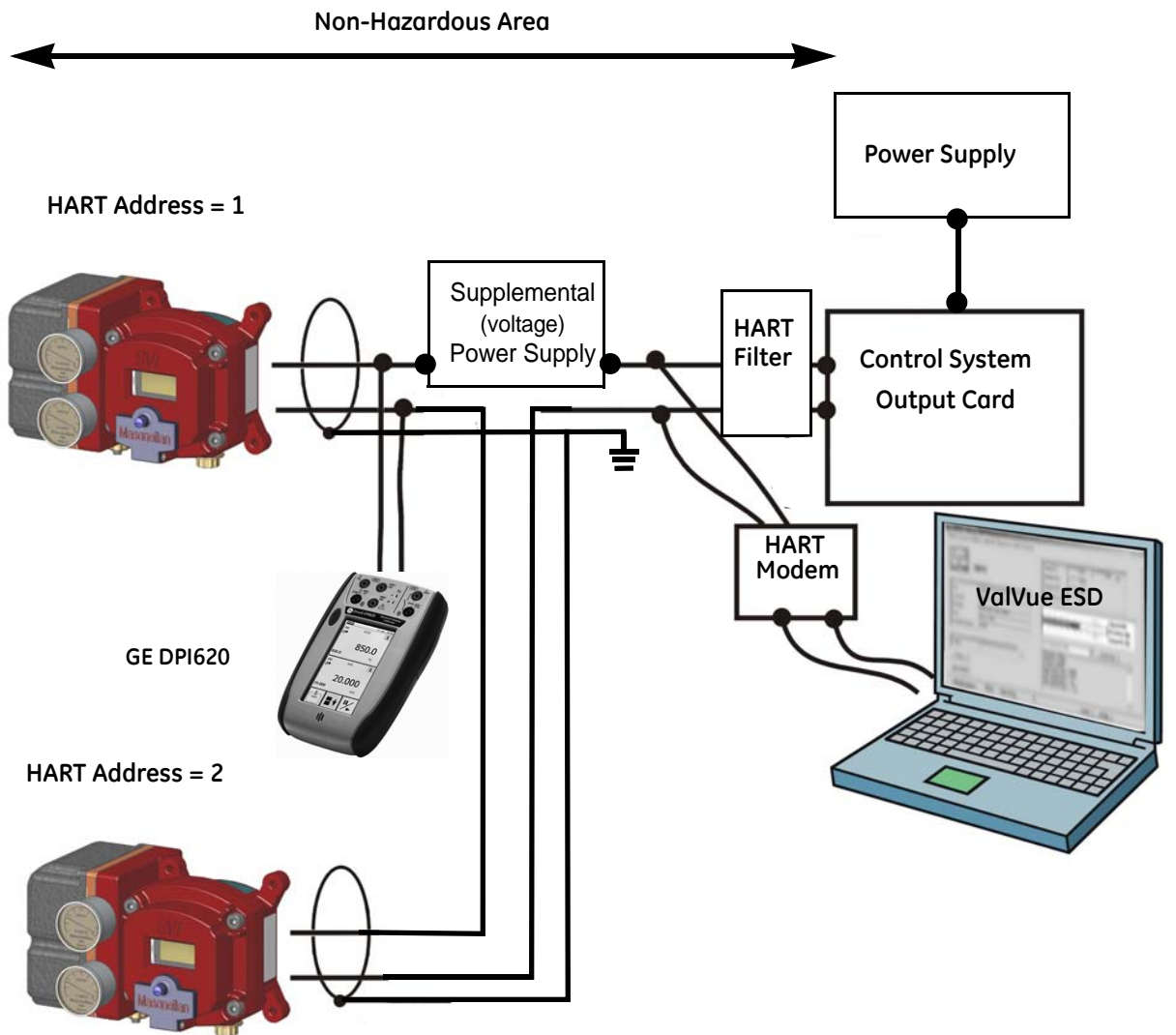

Figure 89 Split Range with Supplemental Power Supply - Non-Hazardous

## Required Practices for Explosion Proof Installations

The SVI II ESD is supplied with two threaded conduit entries. All wiring must be installed with approved conduit and seals or with approved cable and cable glands according to local codes. The spare conduit entry is plugged with a ½" NPT pipe plug. Thread engagement must comply with local electrical codes. The cover must always be secured before applying power.

Do not connect HART<sup>®</sup> communication devices in a hazardous area. Use of the SVI II ESD local display with pushbuttons is recommended when Explosion Proof methods are applied.

### Clarification of Terminology

In Factory Mutual Research and Canadian Standards Association codes, *Explosion Proof* means use of approved enclosures and conduit enclosed cables, while in ATEX code, this method is called *Flameproof*. In ATEX countries, *Explosion Proof* means both Flameproof and Intrinsically Safe.

### Recommended Practice for Severe or Humid Environments

The SVI II ESD circuitry is encapsulated to protect from corrosive atmospheres. To prevent moisture from damaging electronic components of the SVI II ESD in high humidity or tropical environments, a sealed junction box must be used. Wiring from the junction box to the SVI II ESD is sealed by flexible cable with a cable gland or with a potted nipple and pigtail, if in compliance with applicable code.

# HART® DCV Setup

Provided below are instructions for setting up the HART Multiplexer HMU16-P250 for DCV mode application.

## HART® Module Positions

The MTL4841 communications module is mounted in the first available position nearest to RS485 connection terminals. The MTL4842 module is mounted in the last available position nearest to field wiring terminations.

## Field Wiring

Wiring terminations are shown in Figure 90. The transmitter's and the valve's Tx+ terminal is used to supply 24 VDC to the field device. On the system side, the transmitter signal is measured across Ch+ and Ch- while valve signal is simply returned to 0 VDC.

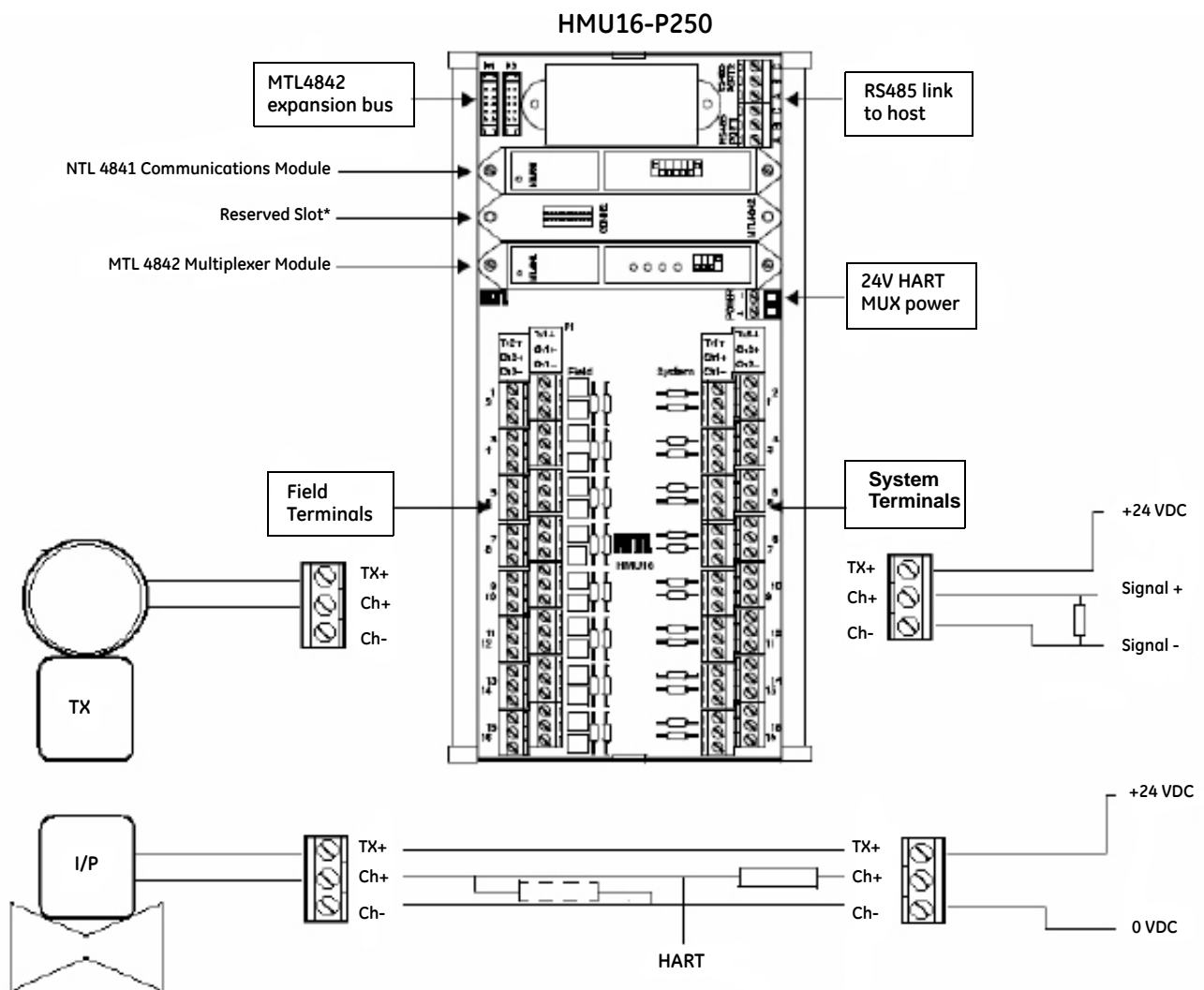

Figure 90 HART® Device in DCV Application

*This page intentionally left blank.*

# Appendix D. HART<sup>®</sup> Communications with Intrinsic Safety

## Overview

When an SVI II ESD is installed in a hazardous area suitable wiring arrangements in addition to safety requirements must be used, in accordance with local applicable codes and standards for Intrinsic Safety. For choice and application of intrinsic safety barriers special training is required. For additional information, consult MTL Instruments PLC Measurement Technology Limited.

All installations must comply with plant standards and local and international electrical codes.

There are three basic barrier types:

- Single channel Zener diode barriers
- Dual channel Zener diode barriers
- Active galvanic isolators

To perform a successful installation with HART<sup>®</sup> communications you must consider HART<sup>®</sup> filter requirements and HART<sup>®</sup> barrier compliance.

# HART<sup>®</sup> Barrier Compliance

The intrinsic safety barrier must be designed to transmit HART<sup>®</sup> signals in a bi-directional way. Both passive Zener diode barriers and active galvanic isolators can be HART<sup>®</sup> compliant. Consult manufacturer or refer to documents listed at the end of this instruction manual.

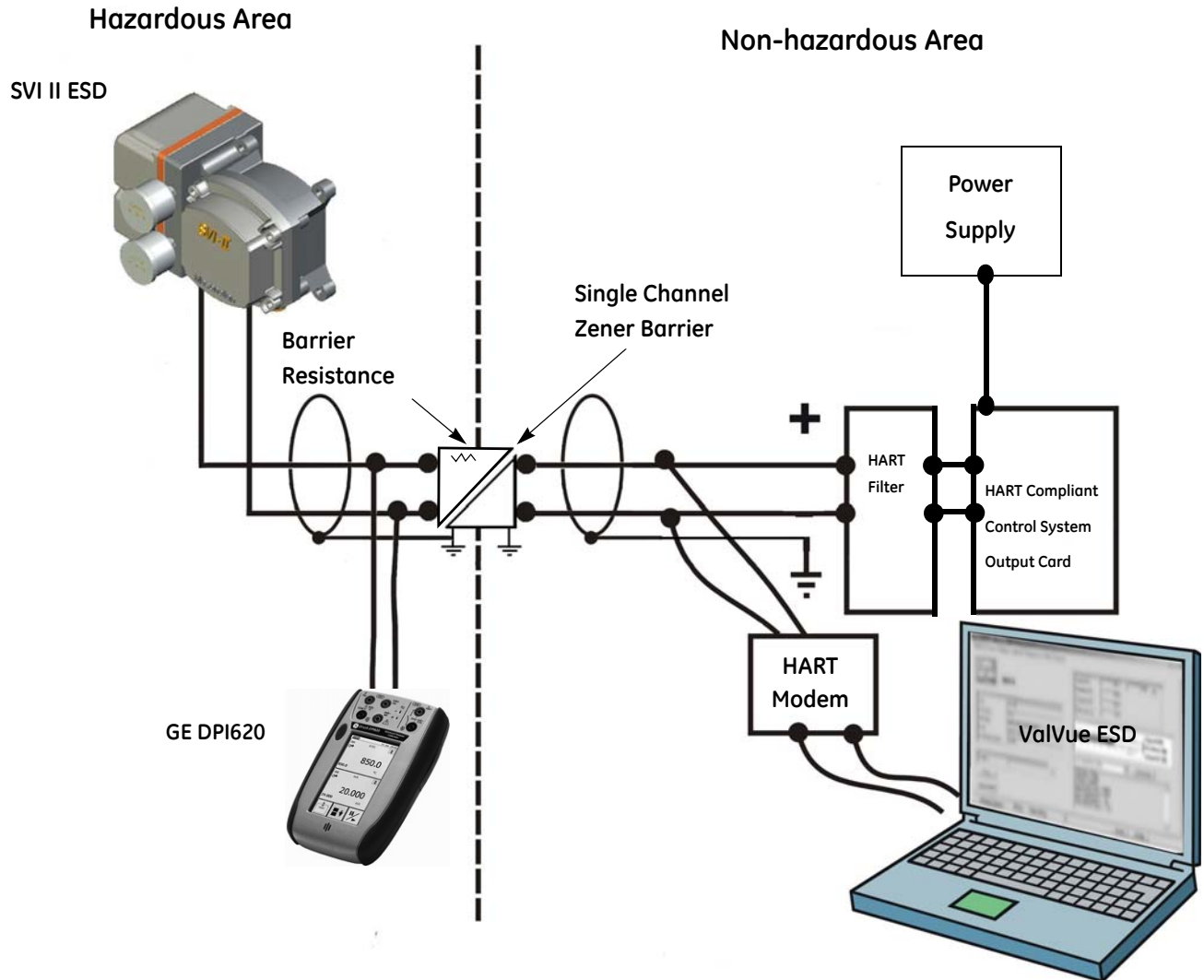

Figure 91 Intrinsically Safe Installation with Zener Barrier and HART<sup>®</sup> Filter



## Output Channel Isolation

The designer of the signaling circuit where the SVI II ESD has to be installed must consider the eight design rules in Wiring Guidelines (see “HART® Wiring Guidelines” on page 179). In particular, the control system output interface has galvanically isolated analog output channels and share a common ground or are separated from ground by a current control transistor or sense resistor.

- If outputs are isolated a single channel Zener diode barrier can be used.
- If outputs share a common ground a single channel Zener diode barrier can be used.
- If outputs are separated from ground a dual channel Zener barrier is required.

Controller outputs are internally separated from ground by a current sense resistor or a control transistor. Dual channel barriers apply excessive loop resistance and can cause compliance voltage problems. An Intrinsically Safe galvanic isolator operates with all three types of output channels, isolated, grounded or separated from ground, and provides sufficient compliance voltage. The galvanic isolator must be certified by the manufacturer to be HART® compliant if the HART® connections are supported on the safe area side of the isolator (Figure 91 on page 198). Consult barrier and isolator manufacturer for devices rated for use with SVI II ESD positioner I.S. entity parameters in Hazardous Area Approvals.

## HART® Filter Requirements

The control system output interface must allow the HART® frequencies to coexist with a 4 - 20 mA DC signal. Circuits not designed for HART® may need a HART® filter. Consult controller or DCS manufacturer for interfacing to any system. HART® communications can cause a non-HART® compliant output circuit to malfunction, in some cases. In other cases HART® communications tones are disabled by the control circuit.

SVI II ESD can be used with non-HART® compliant output circuits but remote communications functionality are disabled.

Use pushbuttons for operation and maintenance. If remote maintenance is desired, always isolate the control valve from the process. Disconnect non-compliant controller before connecting a current source and HART® master device.

If a HART® filter is required, then its voltage drop must be considered when calculating compliance voltage.

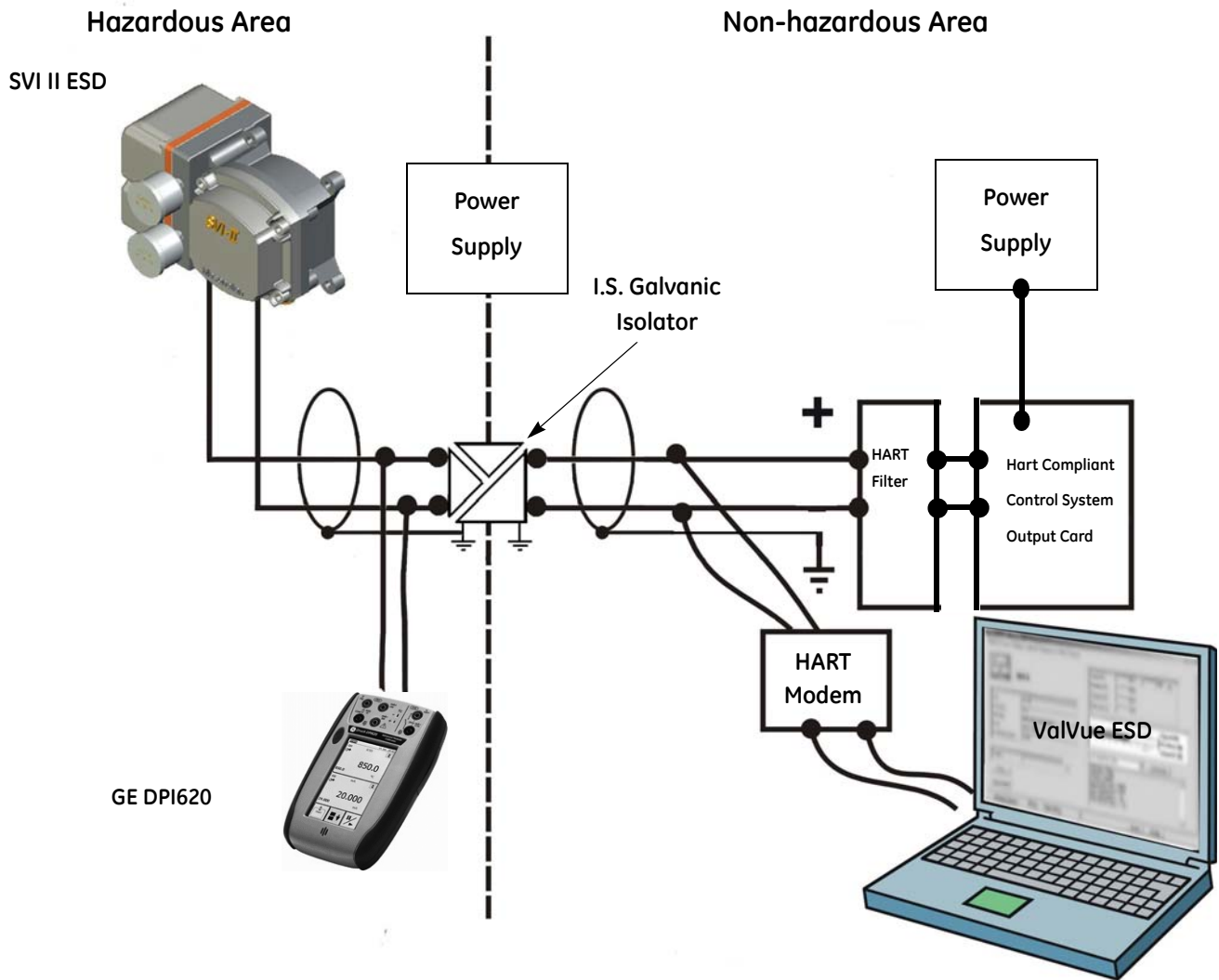

Figure 92 Intrinsically Safe Installation with Galvanic Isolator

**CAUTION**



*Do not connect a HART<sup>®</sup> modem and a PC to a control circuit unless the controller is HART<sup>®</sup> compatible or has a HART<sup>®</sup> filter. Loss of control or a process upset can occur if the controller output circuit is not compatible with HART<sup>®</sup> signals.*

**NOTE**



*A control circuit must be HART<sup>®</sup> compatible or have a HART<sup>®</sup> filter installed. Contact controller or DCS manufacturer. See HART<sup>®</sup> Filter Required for Certain Controls System Output Circuits.*

## Modem and Computer Use in Intrinsically Safe Circuits

Many HART<sup>®</sup> modems in use today are not approved for connecting to Intrinsically Safe control circuits. Most portable computers are NOT approved for use in hazardous areas. Modems can be safely connected to the safe area side of barriers, and isolators. Observe HART<sup>®</sup> filter requirements.

### MACTek<sup>®</sup> Intrinsically Safe modem, Model 010005

The VIATOR RS232 HART<sup>®</sup> Interface [Eex ia] IIC complies with the Essential Health and Safety Requirements relating to the design and construction of equipment and protective systems intended for use in potentially explosive atmospheres. Requirements given in Annex II of the Directive 94/9/EC (ATEX Directive) of the European Parliament and EU Council of 23rd March 1994. Consult MACTek Corporation, <http://www.MACTekcorp.com/company.html> for detailed requirements for safe use.

### MACTek<sup>®</sup> Warning

"This product has not been tested by any certification agency such as Factory Mutual with jurisdiction outside the European Union for intrinsic safety. The product can be used outside the European Union (e.g. in the USA) on the sole authority of the buyer. MACTek<sup>®</sup> makes no claims of suitability and offers no warranties regarding the use of this product for connection of PCs to circuits extending into hazardous areas in countries outside the European Union."

Do not connect a PC or HART<sup>®</sup> modem to an intrinsically safe circuit except on the safe area side of a barrier. Do not operate a PC in a hazardous area without compliance with local and plant regulations.

## Use of Hand-held Communicators In Intrinsically Safe Circuits

### WARNING



*The DPI 620 is not approved for use in hazardous areas that use explosion proof safety practices. Do not use the DPI 620 unless the area has been declared safe (Hot Work Permit).*

The HART<sup>®</sup> Communicator DPI 620 is approved to communicate with intrinsically safe control circuits in hazardous areas. Read the product Manual for the HART<sup>®</sup> Communicator. Observe all warnings. The intrinsic safety entity parameters must be added to the SVI II ESD entity parameters to determine suitability for use in any intrinsically safe circuit. Observe the labels on the DPI 620 or consult the manufacturer.

*This page intentionally left blank.*

# Appendix E. Air to Open and Air to Close Actuators

## Actuator Action

It is important to correctly assign the sign + or - of each control variable throughout a control system. Even the control valve subsystem can be complex. Figure 93 and Figure 94 show air to open action, ATO, and air to close, ATC, valves used with SVI II ESD. The figures show a direct acting positioner with linear and percentage characteristics. Some hysteresis is shown for actuator pressure signal caused by friction in typical actuators. Scales are chosen to emphasize relationships between input current and actuator pressure, so that the failsafe valve position is shown at the lower left of each graph. For an ATC valve, 4 mA represents 100% valve travel not the expected 0%. Controller and other human machine interfaces must correctly show that the valve is fully open (100%) at 4 mA and fully closed (0%) at 20 mA. The graph shows valve movement and actuator pressure when Tight Shutoff, T.S., option is set at about 5%, in this example. Valve movement and actuator pressure are also shown at the low current *lift-off* point at about 3.6 mA, below which positioner is initializing its settings until power is stabilized.

Positioner input, actuator pressure and valve position relationships  
 Direct acting positioner with LINEAR characteristic

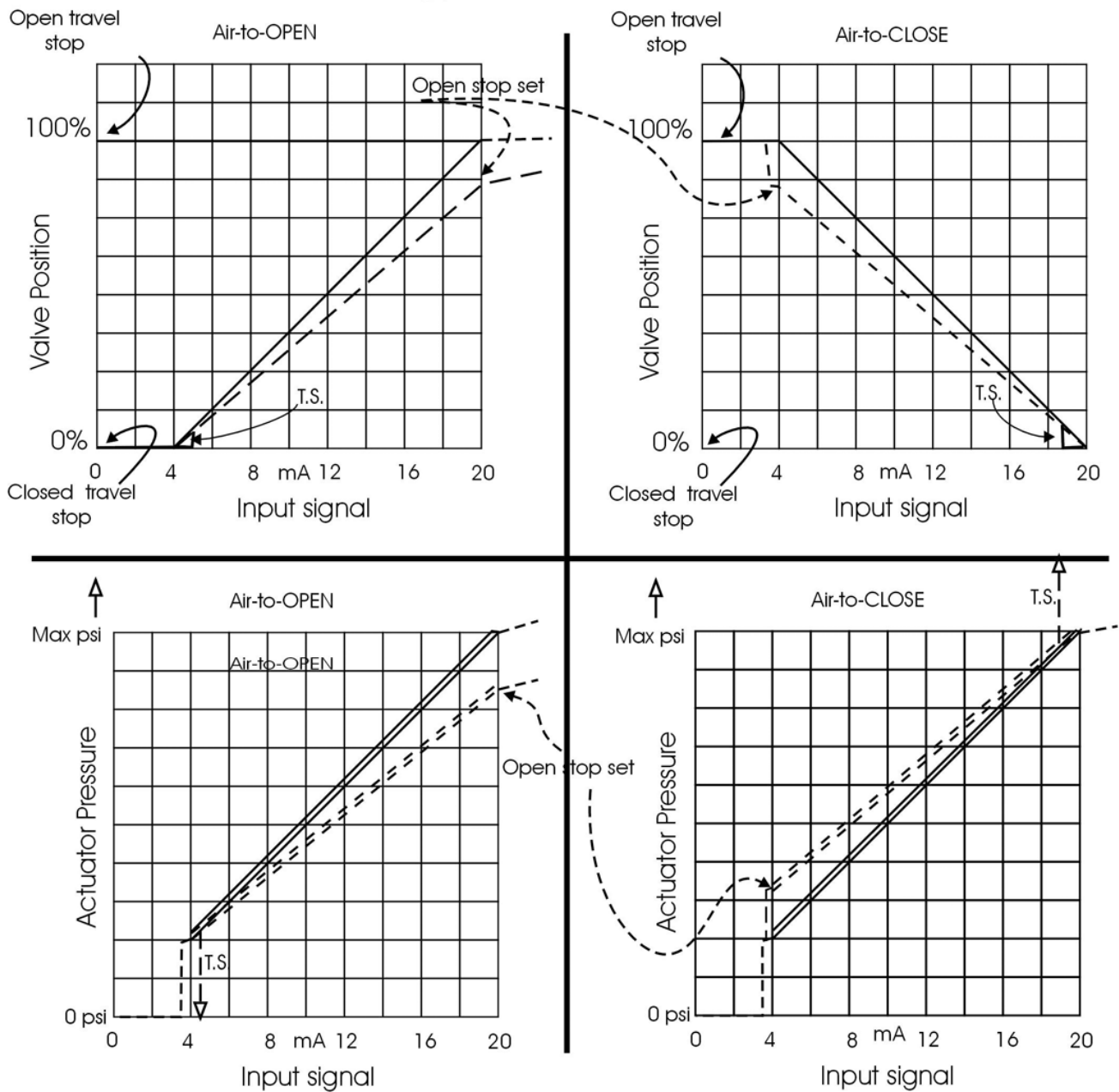
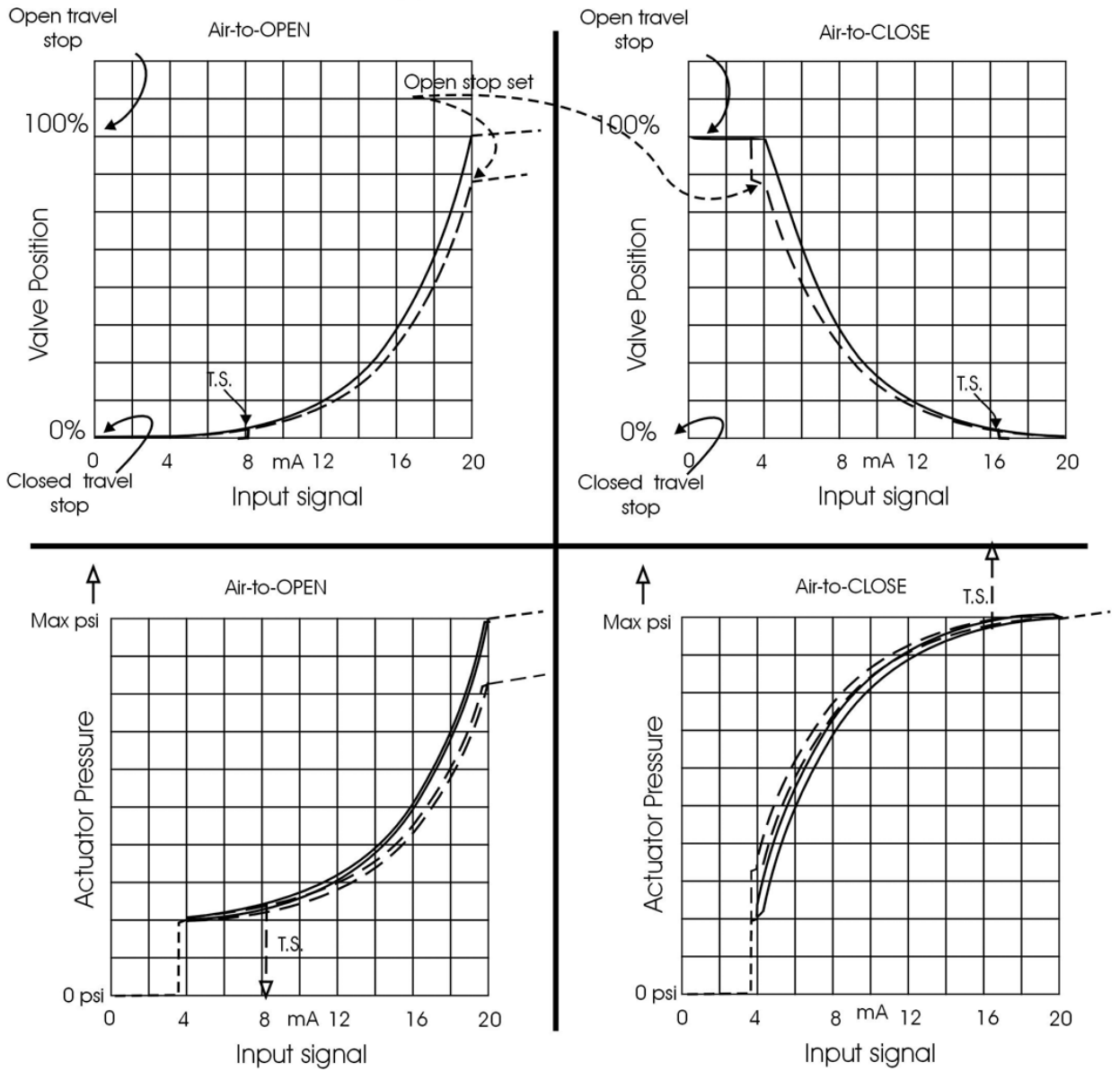

Figure 93 ATO and ATC Action with Linear Positioner Characteristics

Positioner input, actuator pressure and valve position relationships  
 Direct acting positioner with EQUAL 50 characteristic



**Figure 94 ATO and ATC Action in Percentage of Positioner Characteristics**

*This page intentionally left blank.*



## Appendix F. Air Supply Requirements

A high quality air supply greatly improves the quality of control and reduces maintenance costs of pneumatic equipment. See *ANSISA-7.0.01-1996 - Quality Standard for Instrument Air*. Air supply failure requires special attention to minimize process effects. All process equipment should be designed and applied to fail to a safe condition. This includes failure of the air supply. SVI II ESD is designed to fail to a condition of low or no air pressure. Choose control valve actuators to move the valve to a safe condition when air pressure is low or absent. For example, a valve supplying fuel to a combustion process is normally equipped with an Air to Open valve. In other words, the fuel flow is shut off if air fails.

Additional process precautions can be taken. When the air supply recovers, the setpoint to the valve must be at a value that continues to hold the valve in its safe condition, or to move it to a known safe condition. To do so, the control system sending the control valve position setpoint is put into Manual mode and set to 0%. After the air supply has stabilized at its correct pressure, the setpoint is moved to its operation point in accordance with the plant's safe start-up procedures. An additional precaution required on critical processes with an ATO control valve is to install a shut-off valve that supplements the control valve by moving to a safe condition on air failure, and remains in that condition until all necessary requirements for safe start-up have been met.

*This page intentionally left blank.*

## Appendix G. Adjusting Speed of Response

SVI II ESD provides in its calibration software the ability to automatically tune the connected valve. The auto tune feature has robust tuning parameters designed to tolerate variations in process characteristics. You can adjust control valve speed of response by adjusting parameters in SVI II ESD. Tuning parameters are adjusted by ValVue ESD, the preferred method, or by the handheld.

*This page intentionally left blank.*

## Appendix H. Glossary

<i>Accuracy</i>	In a control valve position is measured between mechanical motion limits in the valve. These limits can include position variations due to actuator and valve rigidity. therefore, accuracy is referenced to positions within normal valve travel, independent of rigidity effects at mechanical limits stops. Accuracy is the greatest deviation from the expected position within the normal travel, expressed as normal travel percentage.
<i>Actuator Type</i>	An actuator is a device that transforms an input signal (mainly an electrical signal) into motion. A HART <sup>®</sup> compliant actuator receives a 4 - 20 mA control current signal and causes an actuation function. There are many types of HART <sup>®</sup> actuators; a positioner is a type of actuator. A device of type Actuator can not be connected to a circuit intended for a device of type Transmitter.
<i>Algorithm</i>	An algorithm is a procedure or formula for solving a problem. There are several algorithms entailed in SVI II ESD operation. SVI II ESD has a position control algorithm that is a modified PID algorithm. Other embedded algorithms in SVI II ESD include STOPS method for calibrating stroke, and autoTUNE method for establishing the best parameters for the PID algorithm.
<i>ATC Air to Close</i>	The combination of a single acting actuator and control valve where the valve is closed when air pressure is applied to the actuator.
<i>ATO Air to Open</i>	The combination of a single acting actuator and control valve where the valve is open when air pressure is applied to the actuator.
<i>CALIBrate</i>	A positioner mode of operation in which you have access to changing stroke calibration, input signal, and tuning parameters.

<i>Characteristic</i>	Positioner input setpoint command can be selectively modified to provide a desired relationship between setpoint and valve position. In the valve, the relationship between stroke and Cv is also named valve inherent characteristic. It is often adjusted by design, to equal percentage, for example. Positioner characteristic is applied to modify setpoint to travel relationship of the actuator. The characteristic of positioner must be chosen to compliment the valve. If the valve is equal percentage, the positioner should be set to linear. If a linear valve is installed the positioner can be set to an equal percentage characteristic to improve flow control. SVI II ESD offers an eleven point custom characteristic option that can be created and edited in ValVue ESD. Local display can be used to select custom characteristic, but cannot adjust the points.
<i>Closed</i>	The valve position in which the flow is minimum or zero. See <i>Tight Shutoff</i> .
<i>Compliance Voltage</i>	The available voltage at the control system output in order to drive the control current through the SVI II ESD and all the resistive devices in series with it.
<i>Conformity</i>	The closeness to which position approaches the theoretical position curve, for example equal percentage or quick opening. It is independent of effects due to valve or actuator rigidity at mechanical limits of travel. See <i>Accuracy</i> .
<i>Compliance, HART®</i>	Manufactured and tested in accordance with Field Comm® standards.
<i>Condition Monitoring</i>	A technology for measuring the performance of process equipment and valves over a period of time to predict the need for maintenance. The technology evolved to meet NRC requirements GL 89-10, and has proven valuable to other process industries. SVI II ESD and ValVue ESD offer a suite of diagnostic tools to implement condition monitoring.
<i>CONFIGure</i>	A positioner mode of operation where you have access to changing permanent parameters required for position control or communications.
<i>Custom</i>	The custom characteristic in SVI II ESD has ten points to define (See <i>Characteristic</i> ) the relationship between setpoint and valve position. The pushbuttons allow selection of the custom characteristic that are downloaded as pairs of data using HART® communications from a HART® master. ValVue ESD offers a graphical drag-and-drop method to define the characteristic. It includes a method to correct for geometric non-linearity of positioner feedback linkage.

<i>DCS</i>	Distributed Control System is a generic term for the common control system architecture that generally performs process control in networked computers and interacts with field devices through rack mounted I/O cards. A positioner is usually connected to a DCS output card which controls the 4- 20mA current input to the positioner.
<i>Device Description, DD</i>	The software object installed in the HART <sup>®</sup> Handheld Communicator DPI 620 to allow it to communicate and display the custom parameters available in a field device.
<i>Diagnostics</i>	The suite of software, and hardware tools that allow SVI II ESD to monitor its own internal condition and to monitor the control valve performance and actuator system. Depending on purchased options diagnostics can evaluate number of valve strokes, total accumulated valve stem travel, step response times with graphs, input to position relationships. Often system performance signatures are obtained and retained to compare as-built with future performance to predict remaining useful service life.
<i>EEPROM</i>	An Electrically Erasable Programmable Read Only Memory. SVI II ESD has two memories used for permanent storage of data that change during operation. The micro-controller has EEPROM that permanently stores changing information such as number of actuator cycles and totalized valve travel. The program is stored in flash memory and can be upgraded.
<i>Equal Percentage</i>	A valve characteristic designed to compensate for the loss of pressure in a pipeline as a control valve is opened. It is intended to linearize installed flow versus lift characteristic for improved control. *The theoretical curve is $y = a * e^{x \ln(1/a)}$ , where $a$ is .02, $1/R$ , and $R=50$ for a 50:1 equal percentage characteristic. However, the theoretical curve leaves the valve unseated by 2% at 0% input. Actual curve is corrected to seat the valve at 0%. Corrected curve is $Y = (a * e^{x \ln(1/a)} - a) / (1 - a)$ .
<i>Error Messages</i>	The positioner stores the reasons for errors. Error messages can be read by HART <sup>®</sup> or with local display.
<i>Failsafe</i>	A positioner mode where the valve position is carried to a predetermined safe position. This mode is forced by positioner program in response to errors. If the errors are cleared then RESET returns the positioner to the mode prior to the error.
<i>Fatal Error</i>	An error which the SVI II ESD program treats as non-recoverable. Service is required.
<i>Flash Memory</i>	A non volatile computer memory. It stores all its data even when power is off. It performs high speed reads and can be re-written many times. It is used to store programs and permanent parameters.

<i>FSK</i>	Frequency Shift Keying see HART <sup>®</sup> protocol.
<i>Hall Effect Sensor</i>	A semiconductor magnetic-field sensor that measures the magnetic field perpendicular to the sensor.
<i>HART<sup>®</sup></i>	HART <sup>®</sup> is an acronym for Highway Addressable Remote Transducer. The HART <sup>®</sup> protocol makes use of the Bell 202 Frequency Shift Keying (FSK) standard to superimpose digital signals at a low level on top of the 4-20 mA. This enables two-way communication to take place and makes it possible for additional information beyond just the normal process variable to be communicated to/from a smart field instrument. HART <sup>®</sup> protocol communicates without interrupting the 4-20 mA signal and allows a host application (master) to get two or more digital updates per second from a field device. As the digital FSK signal is phase continuous, there is no interference with the 4-20 mA signal.
<i>Field Comm<sup>®</sup></i>	This foundation is an independent, nonprofit corporation specifically organized to coordinate and support the application of HART <sup>®</sup> technology worldwide. Educating the industry on the capabilities and value of this important technology is a key role. Operating costs are offset by membership and training/support service fees. Membership is open to all suppliers, end users, and others interested in the use of HART <sup>®</sup> technology.
<i>HART<sup>®</sup> Filter</i>	A filter required with certain DCS systems, not HART <sup>®</sup> compliant. It allows the 4 - 20 mA output signal to pass from control system to positioner, but blocks HART <sup>®</sup> FSK tones from passing from the field wiring to the control system.
<i>HART<sup>®</sup> Master</i>	A device, usually a PC controlling communications over a HART <sup>®</sup> protocol network. The HART <sup>®</sup> master sends to a field device a command and requires a response.
<i>HART<sup>®</sup> Slave</i>	A device, normally a transmitter or positioner, that communicates over a HART <sup>®</sup> protocol network only in response to a master device command.
<i>Hazardous Area</i>	The area of the plant where hazard is present, hazards such as explosion due to propane gas in a refinery, or dust in a flour mill.
<i>Hot Swapable</i>	The SVI II ESD in combination with ValVue ESD enables a very brief Mean Time To Repair by the following process: upload all configuration information from installed positioner to ValVue ESD, then replace the positioner and download the configuration file. Run STOPS, and autoTUNE, and the repair is complete.
<i>IP Converter</i>	The current to pressure converting device. SVI II ESD sends an analog current signal to the IP which produces a controlled pressure to the pneumatic amplifying relay.



<i>ISA</i>	The International Society of Automation. ISA develops and publishes international standards for use in process control. See <a href="http://www.isa.org">www.isa.org</a> .
<i>Multidrop</i>	A wiring method for HART <sup>®</sup> Communications Protocol that allows many smart field devices to draw power from and to communicate over a single pair of wires. Though most suited to multiple measurement devices, it can be used with SVI II ESD to permit digital communication of setpoint as well as configuration data, to multiple positioners or a combination of positioners and measurement transmitters. Such communication may not be fast enough for flow control.
<i>Multiplexer</i>	Several instrument suppliers offer equipment that can be connected to multiple cables to monitor and communicate with the attached positioners and transmitters using the HART <sup>®</sup> protocol. Often the multiplexer is used with a DCS that does not support HART <sup>®</sup> .
<i>NAMUR</i>	NAMUR is a European user association of process control technology in chemical and pharmaceutical industries. <i>Recommendations and Worksheets are experience reports and working documents prepared by NAMUR for its members among process control users for facultative utilization.</i> NAMUR issued a recommended accessory mounting for control valves (NE 14 Anschluß von Schwenkantrieben an Armaturen 06.08.96) which describes a method for mounting a positioner on an actuator. See at <a href="http://www.namur.de">www.namur.de</a> .
<i>Neodymium Iron Boron</i>	A magnet alloy which provides the highest energy magnetism available in a permanent magnet.
<i>Non-Volatile Memory</i>	Computer memory whose data is not lost when power is turned off. Used to permanently store calibration, configuration and diagnostic information in SVI II ESD.
<i>NORMAL Mode</i>	The control mode for normal use of a valve positioner. The positioner receives a setpoint from a controller or DCS and applies pressure to the actuator to move the valve to the required position.
<i>PC</i>	As used in this manual, a personal computer or laptop running under Windows 2000 or later operating system.
<i>Position</i>	With a reciprocating valve, position is the distance of plug from its seat, normally measured as a linear motion of the valve or actuator stem. With a rotary valve, position is the angle of rotation of valve plug measured as angular rotation of the valve shaft.
<i>Position Limit</i>	The actuator can be mechanically set to stop at a predetermined position by setting an adjustment, sometimes with a handwheel or screw stop. SVI II ESD can be configured to provide the same limits through position software control.

*Positioner Tuning Parameters*

The positioner requires six integer parameters to determine its response for a setpoint change. Internally, the positioner uses an improved PID control algorithm to control valve position.

**Tuning Parameters**

<i>P</i>	P is a dimensionless gain factor related to proportioning action of the algorithm. It ranges from 0 to 5000. Common values for positioner are 50 for small valves up to 4000 for large valves.
<i>I</i> (0.1 sec)	Integral time or reset time, is the time constant of integral control. Higher values of I cause slower integral action. Common values are 10 (1 second) to 200 (20 seconds). A zero value disables integral action.
<i>D</i> (msec)	Derivative time or rate time is the time constant of derivative control expressed in milliseconds. It ranges from 0 to 200 msec. Common values are 0 to 100. A zero value disables derivative action.
<i>Beta</i>	Beta is a nonlinear dimensionless gain factor, ranging from -9 to 9. When beta is 0, controller gain is linear. Otherwise gain is the error function. The larger the beta, the smaller the gain for small error. Typical beta values for a valve position controller are between -9 and 0.
<i>Padj</i> (%)	Valves often have significantly different response when filling versus exhausting. The proportional gain is adjusted by adding Padj to P when the valve is exhausting. Padj is normally less than P.
<i>Position Compensation Coefficient</i>	The valve response is different when the valve is nearly closed than when it is nearly open. The position compensation coefficient, a number between 0 and 9, allows the control algorithm to optimize valve response.
<i>Damping Coefficient (Boost)</i>	The valve response can be made slower for some applications. A value of 0 gives no damping, and a value of 9 gives maximum damping of valve motion.
<i>Dead Zone</i> (%)	When the valve position is within the setpoint +/- the dead zone, no additional position control is performed. This value is normally 0%, however for high friction valves (e.g. valves with graphite packing), a higher dead zone helps avoid limit cycling due to stick/slip action of the valve. In these cases the chosen dead zone might be 0.2% to 1%.
<i>Quick Opening Relay, Pneumatic</i>	See <i>Characteristic</i> . The component that amplifies pneumatic control signals to provide a wide range of actuation pressure and to supply and vent at high flow rates for responsive control.
<i>Safe Area</i>	The plant area where there is no explosion hazard, such as a control room or a marshalling cabinets area.

<i>Sig Hi</i>	In the SVI II ESD configuration, the input current setting at which a valve is fully open (ATO) or fully closed (ATC).
<i>Sig Lo</i>	In the SVI II ESD configuration, the input current setting at which a valve is fully closed (ATO) or fully open (ATC).
<i>Single Acting</i>	The action of a positioner with a single pneumatic output to operate with a spring return actuator.
<i>Split Range</i>	A control configuration where a single control output is sent to two or more control valves. Each control valve positioner is calibrated to respond to a separate portion of the control signal. An example is a steam valve and a cooling water valve arranged to be both closed at 50% and the steam valve to open.
<i>STOPS</i>	SVI II ESD runs STOPS procedure to adjust the positioner to actual valve travel. First, output pressure is reduced to zero and position is recorded. That is the position corresponding to 0%. Then output pressure is raised to its maximum based on supply pressure. The position is recorded and corresponds to 100%.
<i>Stroke</i>	The total range of valve travel (An accumulated value of 100% travel = 1 stroke. The travel does not need to occur in one movement). Often used as a verb to describe the process of moving the valve.
<i>Tag</i>	The formal designator the control valve used in control loop documentation.
<i>Tight Shutoff (TS)</i>	A positioner property that is selected and adjusted when it is desired to prevent valve operation at or near the closed position. The positioner causes all available actuator force to be applied to the valve seat at a position set point equal to or less than the TS adjustable parameter. A dead band is applied to prevent cycling in and out of this behavior.
<i>ValVue ESD</i>	BHGE's software for calibration, configuration, diagnostics, and PST setup that is provided, on a trial basis with every SVI II ESD.
<i>VDE/VDI 3845</i>	A standard common in Europe for mounting positioners and accessories on rotary valve actuators.
<i>VIEW DATA</i>	A positioner mode of operation in which configuration and calibration parameters can be examined, either remotely or with local display.
<i>VIEW ERR</i>	A positioner mode of operation in which the error status or error messages can be examined.

*This page intentionally left blank.*

# Appendix I. Determining an SVI Positioner Compliance Voltage in a Control System

This discussion explains how to determine compliance voltage for an SVI positioner. It applies to the SVI II AP, SVI II ESD, SVI II APN and SVi1000.

A definition of compliance voltage is: The voltage that must be available at the control system output in order to drive the control current through the SVI II AP and all the resistive devices in series with it.

Measuring the voltage across the SVI II AP terminals doesn't give the true available system compliance voltage as the positioner self-regulates voltage as current flows through it. Additionally, it also doesn't confirm what system voltage is available under load conditions. *Therefore, if compliance testing needs to be done, it is best done before installation.*

Use a 1K potentiometer as this is the maximum for most analog output cards and as at 20 mA this equals 20 VDC, which is a sufficient maximum.

## Compliance Test Setup

1. Configure a test setup as in Figure 95.

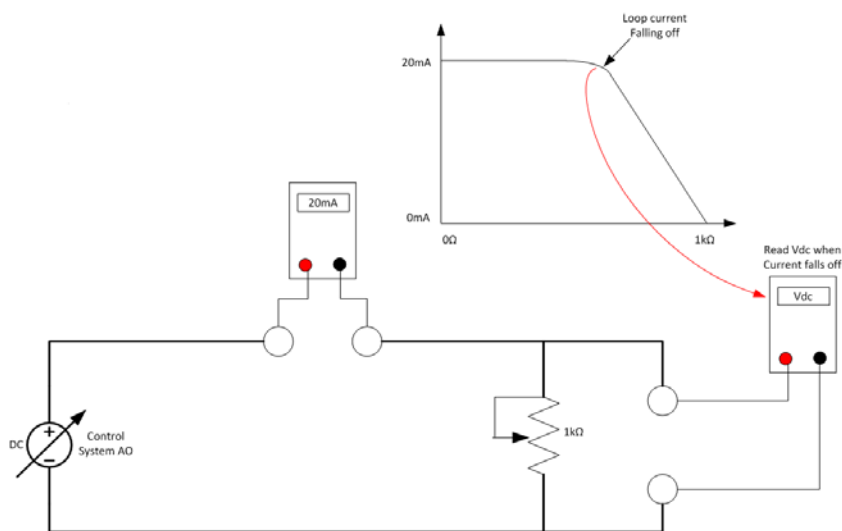

Figure 95 Compliance Voltage Test Setup

2. Send 4 mA to the test setup.
3. Increase the potentiometer value until the loop current reaches 3.95.
4. Read the voltage across the potentiometer, which should be > 11 VDC. This is the available system voltage at the minimum output.
5. Send 20 mA to the test setup.
6. Increase the potentiometer value until the loop current reaches 19.95 mA.
7. Read the voltage across the potentiometer, which should be > 9 VDC. This is the available system voltage at the maximum output.

Table 37 lists some compliance voltage readings at positioner terminals at several currents.

**Table 37 Expected Voltage Range at Positioner Terminals**

<b>Current</b>	<b>Compliance Voltage Requirement at Positioner Terminals</b>	<b>Expected Voltage Measured at Positioner Terminals</b>
4 mA	11 V	10 to 11 V
8 mA	10.5 V	9.5 to 10.5 V
12 mA	10 V	9 to 10 V
16 mA	9.5 V	8.5 to 9.5 V
20 mA	9 V	8 to 9 V

## Appendix J. Burst Mode Operations

The Burst mode is when the HART<sup>®</sup> device continuously sends out data for a device not capable of being polled by a Master. Use this mode only for devices that are passive (i.e. not a HART<sup>®</sup> master), such as a HART<sup>®</sup> to Analog converter (SPA from Moore Industries, Tri-Loop by Rosemount). Turning on Burst mode in cases where it is not required affects the communication bandwidth.

To see how the Burst mode is configured see the SVI II ESD online help.

The Burst mode can send the following commands:

- Cmd1*: PV
- Cmd2*: %range/current
- Cmd3*: Dyn vars/current
- Cmd9*: Device vars w/status
- Cmd33*: Device variables

### Connecting the SPA with the SVI II ESD

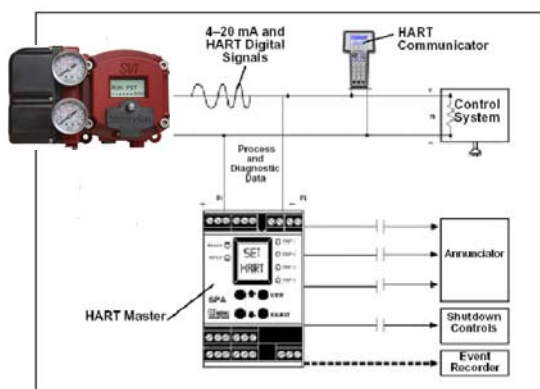

- must be set as a secondary master if the SPA is in polling mode to be able to connect

- PV = Position
- SV = Actuator Pressure
- TV = Supply Pressure
- QV = Pressure 2 N/A

The on/off contacts can be triggered from the status bits sent with every message. The module must be configured to let it know which bit will trigger the contact.

Figure 96 Burst Mode Configuration

*This page intentionally left blank.*









## DIRECT SALES OFFICE LOCATIONS

### AUSTRALIA

Brisbane

Phone: +61-7-3001-4319

Fax: +61-7-3001-4399

Perth

Phone: +61-8-6595-7018

Fax: +61-8-6595-7299

Melbourne

Phone: +61-3-8807-6002

Fax: +61-3-8807-6577

### BELGIUM

Phone: +32-2-344-0970

Fax: +32-2-344-1123

### BRAZIL

Phone: +55-19-2104-6900

### CHINA

Phone: +86-10-5738-8888

Fax: +86-10-5918-9707

### FRANCE

Courbevoie

Phone: +33-1-4904-9000

Fax: +33-1-4904-9010

### GERMANY

Ratingen

Phone: +49-2102-108-0

Fax: +49-2102-108-111

### INDIA

Mumbai

Phone: +91-22-8354790

Fax: +91-22-8354791

New Delhi

Phone: +91-11-2-6164175

Fax: +91-11-5-1659635

### ITALY

Phone: +39-081-7892-111

Fax: +39-081-7892-208

### JAPAN

Tokyo

Phone: +81-03-6871-9008

Fax: +81-03-6890-4620

### KOREA

Phone: +82-2-2274-0748

Fax: +82-2-2274-0794

### MALAYSIA

Phone: +60-3-2161-0322

Fax: +60-3-2163-6312

### MEXICO

Phone: +52-55-3640-5060

### THE NETHERLANDS

Phone: +31-15-3808666

### RUSSIA

Veliky Novgorod

Phone: +7-8162-55-7898

Fax: +7-8162-55-7921

Moscow

Phone: +7 495-585-1276

Fax: +7 495-585-1279

### SAUDI ARABIA

Phone: +966-3-341-0278

Fax: +966-3-341-7624

### SINGAPORE

Phone: +65-6861-6100

Fax: +65-6861-7172

### SOUTH AFRICA

Phone: +27-11-452-1550

Fax: +27-11-452-6542

### SOUTH and CENTRAL AMERICA AND THE CARIBBEAN

Phone: +55-12-2134-1201

Fax: +55-12-2134-1238

### SPAIN

Phone: +34-93-652-6430

Fax: +34-93-652-6444

### UNITED ARAB EMIRATES

Phone: +971-4-8991-777

Fax: +971-4-8991-778

### UNITED KINGDOM

Bracknell

Phone: +44-1344-460-500

Fax: +44-1344-460-537

### Skelmersdale

Phone: +44-1695-526-00

Fax: +44-1695-526-01

### UNITED STATES

Jacksonville, Florida

Phone: +1-904-570-3409

Deer Park, Texas

Phone: +1-281-884-1000

Fax: +1-281-884-1010

Houston, Texas

Phone: +1-281-671-1640

Fax: +1-281-671-1735

[bhge.com](http://bhge.com)

\*Denotes a registered trademark of the Baker Hughes, a GE company LLC.

Other company names and product names used in this document are the registered trademarks or trademarks of their respective owners.

© 2018 Baker Hughes, a GE company, LLC. - All rights reserved.

**BAKER  
HUGHES**  
a GE company



Baker Hughes, a GE company, LLC and its affiliates ("BHGE") provides this information on an "as is" basis for general information purposes and believes it to be accurate as of the date of publication. BHGE does not make any representation as to the accuracy or completeness of the information and makes no warranties of any kind, specific, implied or oral, to the fullest extent permissible by law, including those of merchantability and fitness for a particular purpose or use. BHGE hereby disclaims any and all liability for any direct, indirect, consequential or special damages, claims for lost profits, or third party claims arising from the use of the information, whether a claim is asserted in contract, tort, or otherwise. Baker Hughes, a GE company and the GE monogram are trademarks of the General Electric Company.

GEA18946K

08/2018