

Dry PTC 200

Dry PTC 700

Liquid PTC 165(i)

Liquid PTC 255(i)

Temperature Calibrators
Instruction Manual



Introduction

This technical manual provides operating instructions for the Druck Dry PTC and Liquid PTC temperature calibrators.

Scope

This technical manual contains a brief description, operation and testing procedures for the user of this equipment.

Safety

The manufacturer has designed this equipment to be safe when operated using the procedures detailed in this manual:

- Do not use this equipment for any other purpose than that stated. Incorrect use can prevent the protection given by the equipment from working.
- Use suitably qualified* Technicians and good engineering practice for all procedures in this publication.

Maintenance







The equipment must be maintained using the manufacturer's procedures and should be carried out by authorized service agents or the manufacturer's service departments.

Technical Advice

For technical advice contact Druck or subsidiary manufacturer of this product.

* A qualified technician must have the necessary technical knowledge, documentation, special test equipment and tools to carry out the required work on this equipment.

Marks and Symbols on the Equipment

Symbol	Description
	This equipment meets the requirements of all relevant European safety directives. The equipment carries the CE mark.
	This equipment meets the requirements of all relevant UK Statutory Instruments. The equipment carries the UKCA mark.
	This symbol, on the equipment, indicates that the user should read the user manual.
	<p>This symbol, on the equipment, indicates a warning and that the user should refer to the user manual.</p> <p>Ce symbole, sur l'appareil, est un avertissement qui indique que l'utilisateur doit consulter le manuel d'utilisation.</p>
	<p>This symbol warns the user of the danger of electric shock.</p> <p>Ce symbole alerte l'utilisateur sur le danger de choc électrique.</p>
	<p>This symbol warns the user of the danger of hot surfaces.</p> <p>Ce symbole alerte l'utilisateur du danger des surfaces chaudes.</p>
	<p>Druck is an active participant in Europe's Waste Electrical and Electronic Equipment (WEEE) take-back initiative (directive 2012/19/EU).</p> <p>The equipment that you bought has required the extraction and use of natural resources for its production. It may contain hazardous substances that could impact health and the environment.</p> <p>In order to avoid the dissemination of those substances in our environment and to diminish the pressure on the natural resources, we encourage you to use the appropriate take-back systems. Those systems will reuse or recycle most of the materials of your end life equipment in a sound way. The crossed-out wheeled bin symbol invites you to use those systems.</p> <p>If you need more information on the collection, reuse, and recycling systems, please contact your local or regional waste administration.</p> <p>Please visit the link below for take-back instructions and more information about this initiative.</p>



<https://qrco.de/dsweee>

Abbreviations

The following abbreviations are used in this manual; the abbreviations are the same in the singular and plural.

Abbreviation	Description
A	Ampere
ac	Alternating Current
cm	Centimetre
cSt	Centistokes
dc	Direct Current
DUT	Device Under Test
e.g.	For example
etc.	And so on
FS	Full Scale
GND	Ground
h	Hour
i.e.	That is
K	Kelvin
lbs	Pounds
LED	Light Emitting Diode
m	Minute
max	Maximum
min	Minimum or minute
mm	Millimetre
n/a	Not Applicable
PC	Personal Computer
PID	Proportional Integral Differential
PV	Primary Variable
SP	Set Point
Ref	Reference
RH	Relative Humidity
SP	Set Point
T _R	Room Temperature
USB	Universal Serial Bus
V	Volts
VA	Volt Ampere
°C	Degrees Celsius
°C/min	Degrees Celsius per minute
°F	Degrees Fahrenheit

Contents

1.	Description	1
1.1	Models	1
1.2	Unpacking	1
1.3	Intended Purpose	2
1.4	Warranty	2
1.5	Exclusion of Liability	3
2.	Safety Instructions	3
2.1	Qualified Personnel	3
2.2	General Safety Instructions	3
2.3	Special Safety Instructions	4
2.4	Calibration Liquid Safety Instructions	4
2.4.1	Water	5
2.4.2	Silicone Oil	5
2.4.3	Mineral Oil	5
3.	Construction and Function	6
3.1	Construction	6
3.1.1	Integrated Measurement Instrument	7
3.2	Function	8
3.2.1	Operation Procedure	8
3.3	Test Tasks	9
4.	Commissioning and Operation	9
4.1	Operating Conditions	10
4.2	Electrical Connection	10
4.2.1	Electrical Connection Procedure	10
4.3	Calibrator Preparation	11
4.3.1	Adaptor Sleeve Insert	11
4.3.2	Air Shield Insert	12
4.3.3	Infrared Insert	13
4.3.4	Surface Insert	14
4.3.5	Micro Bath	15
4.3.6	Integrated Measuring Instrument	20
4.3.7	Measurement Interference Suppression	21
4.4	Switching On, Cool Down and Switching Off	21
4.4.1	Switching On	22
4.4.2	Cooling Down the Calibrator	22
4.4.3	Switching Off	22
5.	User Interface	23
5.1	Main Window	23
5.2	Display Range	24
5.3	Toolbar	25
6.	Test Task	26
6.1	Select Test Task	26

6.2	Configure Test Task	26
6.2.1	Name of Test Task	27
6.2.2	Data Acquisition	27
6.2.3	Functionality	27
6.2.4	Device Under Test (DUT)	29
6.2.5	Test Points	30
6.2.6	Alarm Settings	33
6.2.7	Barcode	33
7.	Calibrator Setup	33
7.1	Configure Network	34
7.2	Update Calibrator Software	34
7.3	Configure Presentation Format	34
8.	Testing Process / Calibration	35
8.1	Before Starting	35
8.2	Starting the Testing	36
8.3	Canceling the Testing	36
8.4	After the Testing	37
9.	Measurement Log Management	37
10.	Troubleshooting	38
11.	Maintenance, Cleaning and Transportation	38
11.1	Maintenance	38
11.1.1	Before Use	38
11.1.2	Annually	39
11.1.3	Recalibration	39
11.1.4	Calibration Liquid	39
11.1.5	Magnetic Stirrer	39
11.1.6	Mains Fuses	39
11.2	Calibration	39
11.2.1	Recalibration	39
11.2.2	Adjustment	40
11.3	Cleaning	40
11.3.1	Exterior Chassis	40
11.3.2	Vent Grilles for Inlet Air	40
11.3.3	Inserts	40
11.3.4	Micro Bath	40
11.4	Return Goods/Material Procedure	41
11.4.1	Safety Precautions	41
12.	Decommissioning and Disposal	41
12.1	Before Decommissioning	41
12.2	Decommissioning	41
12.3	Disposal of Calibration Liquid	42
12.4	Disposal of Calibrator	42

13.	Specification	42
13.1	Shared Specification	42
13.2	Dry PTC 200 Specification	43
13.3	Dry PTC 700 Specification	44
13.4	Liquid PTC 165(i) Specification	45
13.5	Liquid PTC 255(i) Specification	47
13.6	Integrated Measuring Instrument	48
13.7	Heating and Cooling Times	49
	13.7.1 Dry PTC 200	50
	13.7.2 Dry PTC 700	50
	13.7.3 Liquid PTC 165(i)	51
	13.7.4 Liquid PTC 255(i)	52

1. Description

The Dry PTC / Liquid PTC calibrators are used to test and calibrate temperature measuring instruments and temperature sensors, as well as for measuring temperatures. Typical applications include the test and calibration of thermometers, temperature switches/thermostats, resistance thermometers and thermocouples.

The portable instruments are of compact and robust construction so can be used on-site or in a laboratory.

The Dry PTC / Liquid PTC series may be used for service purposes, or industrial and laboratory applications.

1.1 Models



Dry PTC 200



Liquid PTC 165



Liquid PTC 255i

Model	Temperature Range	Function	Integrated Measuring Instrument
Dry PTC 200	-55°C to 200°C (-67°F to 392°F)	Dry Block	
Dry PTC 700	T _R to 700°C (T _R to 1290°F)	Dry Block	
Liquid PTC 165	-35°C to 165°C (-31°F to 329°F)	Micro Bath	
Liquid PTC 255	T _R to 255°C (T _R to 491°F)	Micro Bath	
Liquid PTC 165i	-35°C to 165°C (-31°F to 329°F)	Micro Bath	✓
Liquid PTC 255i	T _R to 255°C (T _R to 491°F)	Micro Bath	✓

1.2 Unpacking



INFORMATION The temperature calibrators are delivered in special protective packaging. Save the packaging for returning the instrument safely to the manufacturer for calibration or repair.

- Carefully unpack the unit to prevent any damage.

2. Check the completeness of the delivery based on the delivery note.

Table 1: Delivery Checklist

Item	Dry PTC 200 Dry PTC 700	Liquid PTC 165 Liquid PTC 255	Liquid PTC 165i Liquid PTC 255i
Druck Temperature Calibrator	✓	✓	✓
Mains cable.	✓	✓	✓
PC cable and network cable.	✓	✓	✓
Test certificate.	✓	✓	✓
Directions on how to download the instruction manual.	✓	✓	✓
Protective packaging and transportation protection.	✓	✓	✓
Insert exchange tool.	✓		
Transport cover.		✓	✓
Work cover with five silicone plugs.		✓	✓
Sensor cage.		✓	✓
Magnetic stirrer.		✓	✓
Magnetic lifter.		✓	✓
Drain syringe.		✓	✓
Terminal connectors (4 × red, 4 × black and 1 × white)			✓
2 × Thermocouple adapters.			✓
2 × Clamp-on ferrites.			✓
2 × Ferrite keys (for opening the clamp-on ferrites)			✓

1.3 Intended Purpose

The Dry PTC and Liquid PTC series of calibrators may only be used for the testing and calibration of suitable temperature measuring instruments, temperature sensors and for measuring temperatures.

The calibrators may not be used for warming up or heating materials or gases. The calibrators have been designed for indoor use only.

The micro baths may only be used with a suitable calibration liquid. Permitted liquids are silicone oils, mineral oils and water. See Section 2.4.

Hazardous media (flammable or explosive liquids or gases) may not be used.

The operational safety of the calibrator is only guaranteed by intended use. The specified limits may under no circumstances be exceeded. See Section 13.

It is your responsibility to select the instrument which is suitable for your specific application, to connect it correctly, to carry out the tests safely and to maintain all components.

1.4 Warranty

The calibrator is under guarantee for 12 months from the date of delivery for construction errors or material defects. The guarantee is limited to repair or replacing the calibrator.

Druck also provides an extra 5-year guarantee for calibrators which are calibrated and inspected annually by the Druck's affiliated DAkkS laboratory in Germany.

Opening the calibrator, unauthorized repairs or incorrect use or installation of the calibrator automatically result in the warranty being rendered null and void.

1.5 Exclusion of Liability

We accept no liability for any damage or malfunctions resulting from incorrect installation, inappropriate use of the calibrator or failure to follow the instructions in this operating manual.

2. Safety Instructions

Before you use the calibrator, read through this operating manual carefully. If the instructions are not followed, in particular the safety guidelines, this could result in danger for people, the environment, and the calibrator and the system it is connected to.

The calibrator represents state-of-the-art technology. This encompasses accuracy, operating function and the safe operation of the calibrator.

In order to guarantee that the calibrator operates safely, the operator must act competently and be conscious of safety issues.

Druck provides support for the use of its products either personally or via relevant literature. The customer verifies that our product is fit for purpose based on our technical information. The customer performs customer-specific and application-specific tests to ensure that the product is suitable for the intended use. With this verification, all hazards and risks are transferred to our customers; our warranty is not valid.

2.1 Qualified Personnel

- The personnel in charge of the installation, operation and maintenance of the calibrator must hold a relevant qualification. This can be based on training or relevant instructions.
- Personnel must be aware of this operating manual and have access to it at all times.

2.2 General Safety Instructions

- In all work, the existing national regulations for accident prevention and safety in the workplace must be complied with. Any internal regulations of the operator must also be complied with, even if these are not mentioned in this manual.
- Ensure that the complete operating instructions are always available at the calibrator installation site.
- Degree of protection according to EN 60529. Ensure that the ambient conditions at the site of use does not exceed the requirements for the stated protection rating, see Section 13.1.
- Structural safety in accordance with EN 61010-1. The calibrator must be installed in such a way that the requirements for structural safety are met.
- Only use the calibrator if it is in perfect condition. Damaged or faulty calibrators must be checked without delay and, if necessary, replaced.
- If problems cannot be remedied, immediately shut down the calibrator and ensure that it cannot be started up accidentally.
- Never leave the calibrator unattended when it is in operation or in the cooling phase.
- Do not remove or destroy type plates or other markings on the calibrator, or the warranty is rendered null and void.

2.3 Special Safety Instructions



INFORMATION The transport cover has a pressure relief safety valve. The valve opens when the micro bath pressures exceeds ~1.5 bar. This can result in hot vapor being released.

Remove the transport cover before using the micro bath.

Wait until the micro bath has cooled down before screwing on the transport cover.

- Thermal protection fuse.
 - a. The calibrator is equipped with a thermal protection fuse that works independently. If there is an over-temperature inside the housing, the power supply to the heating system is cut off. The thermal protection fuse is non-resettable. The calibrator cannot be used anymore.
 - b. After the calibrator has cooled, return the calibrator to Druck.
- Risk of injury from hazardous gases.
 - a. When liquids are heated, evaporation can result in dangerous gases being released.
- The calibrator may not be used in a potentially explosive atmosphere.
 - a. Remove all the easily flammable media from the vicinity of the calibrator.
 - b. Ensure that the calibrator cannot come in contact with easily flammable or explosive media.
- Operate the calibrator only in the temperature range permissible for the DUT.
- Ensure that the DUT is held securely in the calibrator.
 - a. Use only suitable inserts.
 - b. When doing so, also ensure that the structural safety of the calibrator is retained.
- Expert mode.
 - a. When selecting the function, DUT and testing tasks, you can switch into the expert mode for administration and configuration. The settings that are made in this mode require detailed knowledge of the calibration and method of working of calibrators.
 - b. If the settings are incorrect, the calibrator may be damaged.

2.4 Calibration Liquid Safety Instructions

Before using calibration liquids, read the entire safety data sheet thoroughly. Pay particular attention to the information on the physical and chemical properties.

Only use calibration liquids that are suitable for the required temperature range and which are not flammable.

Always wear safety goggles when handling calibration liquids. Druck recommends the following calibration liquids:

Table 2: Calibration Liquids

Calibration Liquid	Calibration Range	Flashpoint
Distilled Water	2 °C to 95 °C (35.6 °F to 203 °F)	none
XIAMETER™ PMX-200 Silicone Fluid 5 cSt	-40 °C to 123 °C (-40 °F to 253.4 °F)	133 °C (271.4 °F)
XIAMETER™ PMX-200 Silicone Fluid 10 cSt	-35 °C to 155 °C (-31 °F to 311 °F)	165 °C (149 °F)
XIAMETER™ PMX-200 Silicone Fluid 20 cSt	7 °C to 220 °C (44.6 °F to 428 °F)	230 °C (446 °F)
XIAMETER™ PMX-200 Silicone Fluid 50 cSt	50 °C to 270 °C (122 °F to 518 °F)	280 °C (536 °F)

2.4.1 Water

- Only use distilled water, otherwise excessive limescale and soiling will build up in the calibrator micro bath tank.

2.4.2 Silicone Oil

- Use only the silicone oil recommended in Table 2.
- Always read the safety data sheet supplied with the silicone oil before using it.
- Always ensure adequate ventilation when working with silicone oil, since hazardous substances can be released.
- Prevent silicone oil from coming into contact with your eyes.
- Since silicone oil is hygroscopic, always use the transport cover to close the calibration bath after use.

2.4.3 Mineral Oil

- Druck supplies silicone oil with the calibrators.
- Using mineral oil is possible, but must be done at your own risk. The danger and the risk must be borne by the user and our warranty will be rendered null and void.
- Please follow the safety data sheet of the mineral oil used.
- The safety instructions for silicone oil apply equally to mineral oils as well. The same also applies to the corresponding sections for silicone oil in this operating manual.

3. Construction and Function

3.1 Construction



- | | |
|---|--|
| 1 Carrying handle. | 2 Steel housing. |
| 3 Touch screen for operation and measurement value display. | 4 Mains inlet, switch with fuses. |
| 5 Dry block. | 6 Exhaust cooling air through upper housing grilles. |
| 7 Micro bath with transportation cover. | 8 Exhaust cooling air through side housing grilles. |
| 9 External reference sensor connection. | 10 USB ports and network connection. |
| 11 Inlet air for housing cooling. | 12 Inlet air for dry block / micro bath cooling. |

Figure 1: General View

The calibrator consists of a robust steel housing (2) with integral carrying handle (1). The touch screen display (3) is located on the front panel of the unit.

The mains inlet, switch and fuses (4) are located on the front of the unit. The optional external reference sensor is connected to (9). USB and network connections are available at (10).

During operation, cooling air is drawn in from the base of the unit (11, 12) and expelled through grilles (6, 8). Dry PTC calibrators expel air through the top of the unit (6). Liquid PTC calibrators expel air through side grilles (8).

The rear section of the housing contains the insulated dry block or micro bath. Heating elements, together with an integrated temperature sensor, are used to regulate the temperature of the dry block / micro bath. Some models contain cooling elements. These allow the temperature to be regulated below room temperature.

3.1.1 Integrated Measurement Instrument

The Liquid PTC 165i and Liquid PTC 255i are equipped with an integrated measurement instrument.



Figure 2: Integrated Measurement Instrument

Symbol	Description
RTD A / B	Resistance thermometers (2, 3 or 4-wire) Switch test (socket 1 and 2)
TC A / B	Thermocouple input.
+24V out	Transmitter supply.
mA in	Current measurement.
V in	Voltage measurement.
COM	Signal common (ground).
	Functional earth connection.
ext. Ref.	External reference sensor connection.

3.2 Function

The function of the calibrator is determined by the calibrator model and the installed insert. Figure 3 shows an overview of the available inserts. Table 3 shows the compatibility of insert, calibrator model and function.



Figure 3: Insert Overview

Table 3: Insert Compatibility

Ref	Insert	Function	Dry PTC 200 Dry PTC 700	Liquid PTC 165(i) Liquid PTC 255(i)
1	Adaptor Sleeve	Dry Block	✓	✓
2	Air Shield	Dry Block		✓
3	Infrared	Infrared		✓
4	Surface	Surface		✓
5	Tub	Micro Bath		✓
6	Micro Bath (Direct Filling) ^a	Micro Bath		✓

a. Direct filling of the micro bath with calibration liquid, Liquid PTC models only.

3.2.1 Operation Procedure



INFORMATION For your safety, manual operation of the calibrator, i.e. direct starting and staying at a temperature, is not possible.

The testing procedure is always started with a testing task, see Section 3.3. This ensures that the calibrator is always started with a defined end of test behavior. See “Behavior at Test End” on page 32.

1. Install a suitable insert into the calibrator, see Section 4.3. Ensure that the insert has a secure fit to ensure optimum heat transfer to the DUT.
2. Once all preparations have been completed, switch on the calibrator. See Section 4.4.1.
3. Select the relevant function in the calibrator software for the insert. See Section 6.2.3.

Note: The inserts have different characteristics. The calibrator is supplied with a set of predetermined functions tailored to each insert. These have been determined by the factory and are write protected. They may be used as a basis to create your own custom functions.

4. The calibrator heats or cools the dry block, or calibration liquid, to the set point temperature. As soon as the temperature is stable, the DUT can be calibrated.
5. Repeat step 3 for all of the required calibration set points.

3.3 Test Tasks



INFORMATION The function and the DUT are independent. During the configuration of test tasks (Section 6), the respective expert mode can be entered. This allows administration and configuration when selecting the function or DUT.

Note that changes to existing functions and DUTs always affect all linked test tasks.

Test tasks are containers for defined test conditions. They are helpful for recurring testing processes, for standardizing test sequences and for generating measurement logs.

All required settings and configurations for the calibration of an DUT are compiled in a test task. The parameters of the testing task are saved and linked to the selected function and DUT. See Section 6.

The operation concept of the calibrator is based on pre-installed and self-defined test tasks. They are a central component of the function and operation of the calibrator.

The emphasis of the operating manual is on the use of test tasks during operation of the calibrator.

The calibrator is shipped with pre-defined functions, test samples and testing tasks. These have been defined in the factory, in which the basic settings of the calibrator have been stored. If desired, customer-specific test tasks can be created.

The protected test tasks can be neither be deleted nor edited. They serve as templates for your own self-defined test tasks. They can be copied and then modified.

You can define your own test tasks for different DUT or test sequences. These test tasks are directly saved in the calibrator and can be easily activated. This makes quick access to recurring test tasks possible.

Upon switching on the calibrator, the first test task of the selection list is loaded automatically, with the relevant parameters.

4. Commissioning and Operation



WARNING The calibrator may become very hot during operation. If the calibrator is operated without supervision, third-party persons in the vicinity could get injured. Moreover, flammable material could come into contact with the calibrator and cause significant harm to personnel and/or damage to property.

Never leave the calibrator unattended when it is in operation or in the cooling down phase.

For safe operation of the calibrators, a formal commissioning procedure is necessary.

Commissioning includes the installation, electrical connections, preparation for the calibration as well as correct switching on and off of the calibrator.

Further, a visual inspection for damage is required before use.

The required steps are described in the following sections.

4.1 Operating Conditions



INFORMATION The plug of the mains connecting cable serves as a emergency stop device. Ensure that the plug is always easily accessible and easy to reach. In an emergency, pull the plug so that the calibrator is isolated from the mains.

Select a safe installation site for commissioning the calibrator.

Considerations for selecting a safe installation site and calibrator operating position:

- Only suitable for indoor use, do not use outdoors.
- Operate only in the vertical position on an even surface. The surface must be stable, clean, and dry.
- If the operational conditions do not conform to the above, the structural safety and the specified properties of the calibrator cannot be guaranteed.
- At high testing temperatures, it is recommended to use a sufficiently large, fire-resistant, supporting surface.
- Ensure sufficient clearance around the calibrator. On the front side > 1 m, behind and to the sides > 0.5 m. Ensure that there is sufficient head clearance and sufficient clear space above the calibrator.
- Ensure sufficient ventilation.
- Do not operate in the vicinity of flammable materials.
- Do not install in a cupboard or other similar confining location.
- The ventilation openings must not be blocked or covered.
- The calibrator must be installed so that it can be switched off at any time.

4.2 Electrical Connection

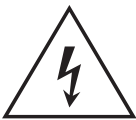

RISK OF ELECTRIC SHOCK Calibrators that have been exposed to high humidity for long periods have an initial higher than normal earth leakage current. Ensure that the calibrator is always connected to a protective earth.

Always use a known good mains cable with an appropriate power plug.

Use only a Druck specified mains cable.

Ensure that the mains outlet is adequately rated and has a protective earth connection.

Before turning on the power, make sure that the calibrator is properly connected to the protective earth. The protective earth is connected to the calibrator through the mains plug.

Check the following points before you connect the calibrator:

1. Check the specified operating mains supply voltage range for the calibrator. See Section 13.
2. Ensure that the mains voltage range is the same as that specified on the rating plate.
3. Only connect the calibrator to a properly installed and earthed 3-pole socket for mains plugs with earthing contact.
4. Only use extension cables or adaptor plugs with a protective earth connection.

4.2.1 Electrical Connection Procedure

1. Insert the mains cable into the mains inlet socket of the calibrator.
2. Insert the plug of the mains cable in a suitable mains outlet with earthing contact.

4.3 Calibrator Preparation



HOT SURFACE The calibrator may become very hot when in operation. Touching hot parts can result in serious injuries.

Never touch the dry block, micro bath, inserts or the DUT at temperatures above 35 °C (95 °F) or below 10 °C (50 °F).

Allow the calibrator to cool before you remove the DUT, change the insert or switch off the calibrator.



INFORMATION Empty and clean the micro bath tank after usage (Liquid PTC models only). Otherwise inserts may become stuck in the calibrator.

The preparations for the micro bath must be carried out with the calibrator switched off and cooled to room temperature.

The function of the calibrator is determined by the installed insert. The required insert is installed into the opening of the dry block or micro bath. By using inserts, it is easy to switch between dry block, infrared, surface and micro bath functions.

For an overview of insert compatibility, see Section 3.2 on page 8.

4.3.1 Adaptor Sleeve Insert

Adaptor sleeves with single or multiple holes are used for the calibration of straight temperature sensors. For adaptor sleeve insert compatibility, see Section 3.2 on page 8.



- 1 Brass adaptor sleeves. (Dry PTC models only)
- 2 Aluminum adaptor sleeves. (Liquid PTC models only)
- 3 Insert exchange tool.
- d Borehole diameter.
- h Homogeneous zone. 40 mm (1.6")

Figure 4: Adaptor Sleeve Inserts

To achieve the specified accuracy of the calibrator, the DUT and the adaptor sleeve must be matched to one another:

1. The borehole of the adaptor sleeve must be no greater than 0.5 mm of the DUT diameter.
2. The measurement element of the DUT must be located in the homogeneous temperature zone of the adaptor sleeve. See Figure 4, dimension h.

4.3.1.1 Installation



INFORMATION Use only Druck adaptor sleeves.
If in doubt, contact Druck.

The adaptor sleeve is inserted into the dry block using the insert exchange tool, see Figure 4 item 3.

4.3.1.2 External Reference Sensor (Optional Accessory)

Align the adapter sleeve so that the hole for the external reference sensor is located at 12 o'clock.

4.3.1.3 Removal and Cleaning

1. Allow the calibrator cool before the adaptor sleeve is removed.
2. Pull the adaptor sleeve out of the dry block with the help of the insert exchange tool, see Figure 4 item 3.
3. Clean the adaptor sleeve and the dry block to prevent inserts from getting stuck in the dry block.

4.3.2 Air Shield Insert

The air shield insert provides optimum radial and axial temperature distribution. The borehole divider provides a flexible and cost-effective adaptation to various calibration tasks. For air shield insert compatibility, see Section 3.2 on page 8.

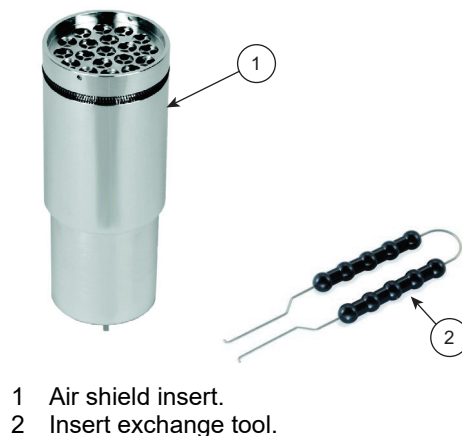

- 1 Air shield insert.
- 2 Insert exchange tool.

Figure 5: Air Shield Insert

4.3.2.1 Installation

The air shield is inserted into the dry block using the insert exchange tool, see Figure 5 item 2.

4.3.2.2 External Reference Sensor (Optional Accessory)

Align the air shield so that the hole for the external reference sensor is located at 12 o'clock.

4.3.2.3 Removal and Cleaning

1. Allow the calibrator cool before the air shield is removed.
2. Pull the air shield out of the dry block with the help of the insert exchange tool, see Figure 5 item 2.
3. Clean the air shield and the dry block to prevent inserts from getting stuck in the dry block.

4.3.3 Infrared Insert

The infrared insert is used for contact-less measurement infrared thermometers. The infrared insert has a specially designed surface and surface coating on the inside. As a result, an emissivity of 0.9994 (black body) is achieved.

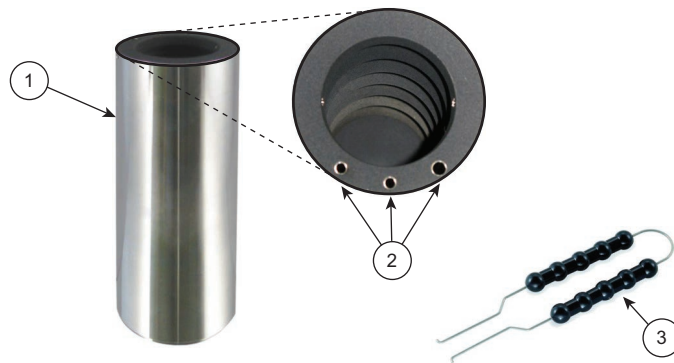

- 1 Infrared insert.
- 2 External sensor bore holes:
2 × 3.5 mm (0.138")
1 × 4.5 mm (0.177")
- 3 Insert exchange tool.

Figure 6: Infrared Insert

The additional holes in the border, see Figure 6 item 2, are for external reference sensors. This allows the exact temperature of the inside face of the infrared insert to be determined.

4.3.3.1 Installation

1. The infrared insert is inserted into the dry block using the insert exchange tool, see Figure 6 item 3.
2. Centre the infrared insert so that there is an even air gap between the infrared insert and the dry block.

4.3.3.2 External Reference Sensor (Optional Accessory)

Align the infrared insert so that the hole for the external reference sensor is located at 12 o'clock.

4.3.3.3 Removal and Cleaning

1. Allow the calibrator cool before the infrared insert is removed.
2. Pull the infrared insert out of the dry block with the help of the insert exchange tool, see Figure 6 item 3.
3. Clean the infrared insert and the dry block to prevent inserts from getting stuck in the dry block.

4.3.3.4 Application Tips

1. The measuring spot of the infrared thermometer must project itself onto the floor of the infrared insert during the calibration. The measuring spot must be smaller than the inner diameter and must not touch the wall of the infrared insert.
2. Ice or condensation can form in the infrared insert at temperatures of less than 0 °C (32 °F) in high humidity levels. This can affect the emissivity of the infrared insert and degrade the calibration accuracy. Ice or condensation formation can be reduced by:
 - a. Covering the measuring opening of the infrared insert.
 - b. Keeping the measuring opening closed for as long as possible.
 - c. Only opening the measuring opening briefly for the calibration.

Note: Ice or condensation can be removed by gently heating the infrared insert.

4.3.4 Surface Insert

The surface insert is used for calibrating surface temperature sensors. The surface insert is hollow in construction. When installed, the top portion of the surface insert protrudes above the dry block.



- 1 Surface insert.
- 2 External sensor bore holes:
 - 1 × 3.0 mm (0.118")
 - 1 × 3.1 mm (0.122")
 - 1 × 4.5 mm (0.177")
- 3 Insert exchange tool.

Figure 7: Surface Insert

The additional holes in the border, see Figure 7 item 2, are for external reference sensors. This allows the exact temperature of the surface insert to be measured.

The two threaded boreholes in the border are for the accompanying exchange tool.

4.3.4.1 Installation

1. The surface insert is inserted into the dry block using the exchange tool, see Figure 7 item 3.
2. Centre the surface insert so that there is an even air gap between the surface insert and the dry block.

4.3.4.2 External Reference Sensor (Optional Accessory)

Align the surface insert so that the hole for the external reference sensor is located at 12 o'clock.

4.3.4.3 Removal and Cleaning

1. Allow the calibrator cool before the surface insert is removed.
2. Pull the surface insert out of the dry block with the help of the exchange tool, see Figure 7 item 3.
3. Clean the surface insert and the dry block to prevent inserts from getting stuck in the dry block.

4.3.4.4 Application Tips

When using an external reference sensor, insert the sensor into the borehole so that its measuring element is situated under the middle of the calibration surface.

4.3.5 Micro Bath



WARNING Wear safety goggles. Calibration liquid may be ejected when working with the micro bath. Always wear safety goggles when handling calibration liquids.

The micro bath is used for calibrating sensors with special shapes or dimensions. Direct contact between the sensor and the calibration liquid ensures excellent heat transfer.

The calibration liquid is poured directly into the micro bath tank / tub insert.

The micro bath includes the following accessories:

- Transport Cover
- Work Cover
- Sensor Cage
- Magnetic Stirrer
- Drain Syringe
- Magnetic Lifter

Note: A removable tub insert is available as an optional accessory.

The accessories are described in more detail in the following sections.

4.3.5.1 Transport Cover



WARNING Remove the transport cover before using the micro bath.

The transport cover has a pressure relief safety valve. The valve opens when the micro bath pressures exceeds ~1.5 bar. This can result in hot vapor being released.

The transport cover seals the micro bath, preventing spillage of the calibration liquid during transportation.



Figure 8: Transport Cover

4.3.5.2 Work Cover



Figure 9: Work Cover

The work cover is used to:

- a. Reduce evaporation of the calibration liquid.
- b. Reduce the cooling of the surface of the calibration liquid.
- c. Provide stable positioning of the DUT in the micro bath.

The work cover is screwed on to the micro bath and has five openings for DUT. The unused openings can be closed with the suitable silicon plugs.

4.3.5.3 Sensor Cage and Magnetic Stirrer

The sensor cage protects the magnetic stirrer. It prevents the DUT from stopping the magnetic stirrer from rotating.

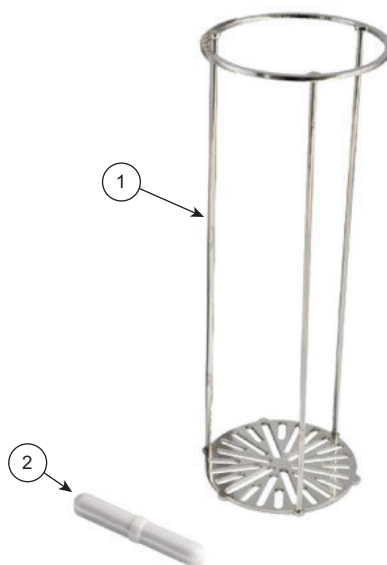

- 1 Sensor cage.
- 2 Magnetic stirrer.

Figure 10: Sensor Cage and Magnetic Stirrer

The magnetic stirrer ensures a uniform temperature distribution in the calibration liquid. Use the thumb wheel, see Figure 1 item 10, to control the speed of the magnetic stirrer.

Note: The magnetic stirrer is subject to mechanical wear and tear during normal operation. The magnetic stirrer has a limited lifetime and requires periodic replacement. See Section 8.1.

4.3.5.4 Drain Syringe and Magnetic Lifter

The drain syringe is used to pump out the calibration liquid from the micro bath. The magnetic stirrer is removed with the help of the magnetic lifter.



Figure 11: Magnetic Lifter

Note: The micro bath must be drained of calibration liquid and the magnetic stirrer removed before another insert is inserted into the calibrator.

4.3.5.5 Tub Insert (Optional Accessory)

The tub insert is a removable calibration liquid container. It is designed to be inserted and used in the micro bath tank of the calibrator.



- 1 Tub insert.
- 2 Tub insert transport cover.
- 3 Insert exchange tool.

Figure 12: Tub Insert

A tub insert is highly recommended if workload involves:

- a. Frequent changes between dry block, infrared, surface and micro bath function.
- b. Frequent changes between different calibration liquids.

The tub insert is inserted into the micro bath using the insert exchange tool, see Figure 12 item 3. The tub insert is supplied with a transport cover to prevent spillage of the calibration liquid during transportation.

4.3.5.6 Notes on Calibration Liquid



WARNING Wear safety goggles. Calibration liquid may be ejected when working with the micro bath. Always wear safety goggles when handling calibration liquids.

Different calibration liquids give different calibration results due to their specific characteristics. Adjustment to the respective calibration liquid has to be carried out by the manufacturer.

In order to achieve the best possible accuracy of a micro bath, it has to be filled with a suitable calibration liquid. The calibration liquid is poured directly into the micro bath tank / tub insert.

Note: It is recommended to use silicone oil as the calibration liquid.

1. When using water as the calibration liquid:
 - Only use distilled water, otherwise excessive limescale and soiling will build up in the tank.
2. When using silicone oil as the calibration liquid:

- Always read the safety data sheet supplied with the silicone oil before use.
- Always ensure adequate ventilation when working with silicone oil. Hazardous substances may be released.
- Spilled or leaked silicone oil results in an extreme danger of slipping. Always clean up spills.
- Silicone oil is hygroscopic. Use the transport cover to seal the micro bath, or tub insert, after use.

4.3.5.7 Notes on Cleanliness



INFORMATION Only use clean calibration liquid.

The verification and calibration of DUT can lead to a contamination of the calibration liquid. Contamination can lead to smeary gel effect on the bottom of the tank due to the rotation of the magnetic stirrer. This can effect the calibration accuracy.

It is highly recommended to:

1. Clean the micro bath tank / tub insert.
2. Clean the DUT before calibration.
3. Replace worn magnet stirrers.
4. Replace contaminated calibration liquid.

4.3.5.8 Notes on Calibration Liquid Fill Level



PREVENT FAILURE Do not exceed the maximum fill level during operation. Overflow of calibration liquid causes contamination and may cause damage to the calibrator.



INFORMATION Incorrect calibration liquid fill level results in inaccurate calibration. Filling above the maximum fill level leads to excessive heat dissipation, preventing compliance with specified tolerances.

The fill level in the micro bath or tub insert rises as a result of:

- a. Thermal Expansion – Calibration liquids expand to varying degrees as a result of heating. The increase in fill level depends on the calibration liquid in use and the applied temperature.
- b. Displacement by Sensors – The volume displaced by DUT must be taken into account in determining the filling amount.
- c. Rise due to Stirring – The rotation of the magnetic stirrer forms a whirlpool in the liquid. This raises the fill level at the wall.

The maximum fill levels are shown below:

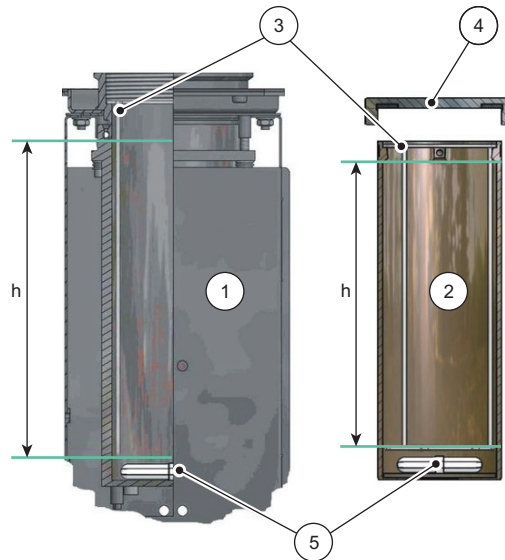

- 1 Micro bath tank.
- 2 Tub insert.
- 3 Sensor cage.
- 4 Tub insert transport cover.
- 5 Magnetic stirrer.

Figure 13: Maximum Fill Level

	Micro Bath Tank	Tub Insert
Maximum Fill Level (h)	150 mm (5.91")	136 mm (5.35")
Maximum Fill Volume	~0.45 litres (15.22 fl oz)	~0.32 litres (10.82 fl oz)

Note: The maximum fill level line for the micro bath tank is located next to the upper edge of the aluminum lining. The maximum fill level line for the tub insert is below the sleeve exchange tool fixture.

4.3.5.9 Filling with Calibration Liquid



INFORMATION Pay attention to maximum calibration liquid filling level, see Section 4.3.5.8.

When filling, leave enough room for thermal expansion, displacement by the DUT and level rise due to stirring.



Figure 14: Filling with Calibration Liquid

Micro bath filling procedure:

1. Unscrew the transport cover of the micro bath.

2. Place the magnetic stirrer into the micro bath.
3. Insert the sensor cage.
4. Insert the DUT into the sensor cage, before filling, to account for its volume.
5. Fill the micro bath with calibration liquid.

Note: Observe the maximum fill level and leave sufficient reserve space for an additional rise in the level.

6. If necessary, remove the DUT.
7. Screw the work cover into place.
8. Insert the DUT through the work cover into the micro bath.

Tub insert filling procedure:

1. Unscrew the transport cover of the tub insert.
2. Insert the tub insert into the micro bath tank using the sleeve exchange tool.
3. Place the magnetic stirrer into the tub insert.
4. Insert the sensor cage.
5. Insert the DUT into the sensor cage, before filling, to account for its volume.
6. Fill the tub insert with calibration liquid.

Note: Observe the maximum fill level and leave sufficient reserve space for an additional rise in the level.

7. If necessary, remove the DUT.
8. Screw the work cover into place.
9. Insert the DUT through the work cover into the tub insert.

4.3.6 Integrated Measuring Instrument

The following section applies to Liquid PTC 165i and Liquid PTC 255i with the integrated measuring instrument.

4.3.6.1 Connecting the DUT (Thermocouple)

1. Connect the cable ends to the terminal connectors, or thermocouple adapter, to the appropriate inputs.
2. Connect the cable screen to the earthing socket if necessary.

4.3.6.2 Connecting the DUT (mA or V)

Connect the temperature sensor to the integrated measuring instrument as follows:

- Current signal:
 1. 3-wire DUT with voltage supply from calibrator:
 - a. Voltage supply for test specimen: socket "+24 V out".
 - b. Signal: "mA in".
 - c. GND: GND
 2. 2-wire DUT with voltage supply from calibrator:
 - a. Voltage supply for test specimen: socket "+24 V out".
 - b. Signal: "mA in".
 3. 2-wire DUT with voltage supply from calibrator:
 - a. Signal: "mA in".
 - b. GND: GND

- Voltage signal:
 1. 3-wire DUT with voltage supply from calibrator:
 - a. Voltage supply for test specimen: socket “+24 V out”

Note: The DUT must be suitable for a supply voltage of 24 V.
 - b. Signal: “V in”.
 - c. GND: GND
 2. 2-wire DUT with voltage supply from calibrator: Not possible.
 3. 2-wire DUT with voltage supply from calibrator:
 - a. Signal: “V in”.
 - b. GND: GND

4.3.7 Measurement Interference Suppression

If the DUT cable has no cable screen and the measurement result is affected by electromagnetic interference, Druck recommends using a clamp-on ferrite. Insert the DUT cable into the clamp-on ferrite. It is recommended to wrap the DUT cable with multiple turns around the clamp-on ferrite. For optimum results, match the ferrite’s damping properties to the interference frequency.

4.3.7.1 Attaching the Clamp-on Ferrite

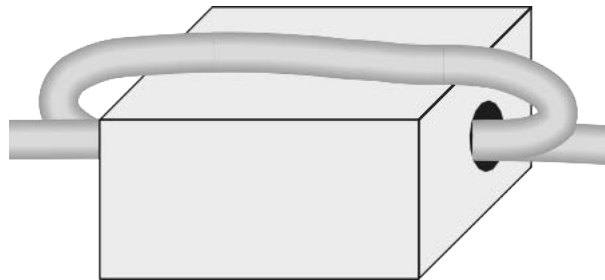

Figure 15: DUT Cable with Clamp-on Ferrite

1. Open the clamp-on ferrite.
2. Place the DUT cable into the clamp-on ferrite.

Note: Attach the clamp-on ferrite as close as possible to the calibrator’s measurement connectors.
3. Wrap the DUT cable with multiple turns around the clamp-on ferrite, see Figure 15.
4. Close the clamp-on ferrite.

4.3.7.2 Removing the Clamp-on Ferrite

1. Open the clamp-on ferrite with the supplied ferrite key.

4.4 Switching On, Cool Down and Switching Off

For reasons of safety, when switching on the calibrator, the fan runs at the fastest speed. As soon as the internal reference sensor has measured a safe temperature, the fan speed is adjusted accordingly.

4.4.1 Switching On



WARNING The calibrator must be securely connected to protective earth, otherwise there is a danger to life from electric shock.

Before turning on the power, make sure that the earth connection of the calibrator is properly connected to the protective earth.



WARNING After transport, storage or long periods of non-use, moisture can seep into the heating elements (magnesium oxide).

To dry the heating elements, the calibrator must be slowly warmed up. During this process, the calibrator has not yet reached the required electrical insulation for protection class I.

To dry the heating elements, set the calibrator to 120 °C (248 °C) for at least 15 minutes.



INFORMATION Do not expose the calibrator to high levels of humidity for a long time. Excessive condensation can occur on the calibrator if a cold unit is brought into a considerably warmer place.

Before switching on the calibrator, allow it to acclimatise for at least 2 hours at room temperature.

1. Turn on the mains switch.
2. The fan of the calibrator starts and the Druck logo appears on the screen.
3. The type designation and the current software version are displayed.
4. The main window is displayed and the calibrator is ready for operation.
5. The first entry in the selection list, with its parameters, is displayed as the test task.

4.4.2 Cooling Down the Calibrator



HOT SURFACE The calibrator may become very hot when in operation. Touching hot parts can result in serious injuries.

Never touch the dry block, micro bath, inserts or the DUT at temperatures above 35 °C (95 °F) or below 10 °C (50 °F).

Allow the calibrator to cool before you remove the DUT, change the insert or switch off the calibrator.



INFORMATION In the event of mains failure, or if the mains switch is turned off, or if the mains plug is removed due to an emergency stop, the built-in fan stops and does not provide cooling. Sufficient thermal decoupling between the micro bath / dry block and the housing is nonetheless guaranteed.

To avoid injuries or material damage, it is necessary to cool down the calibrator.

Use the shutdown icon to cool the calibrator to a safe temperature. See “Safety Temperature Value” on page 32.

4.4.3 Switching Off



INFORMATION Only switch off the calibrator when the dry block / micro bath has reached room temperature.

When switching off at high temperatures, the calibrator and/or the DUT may be damaged.

1. Tap the  icon until the main window is displayed.

2. Tap the  icon to shutdown the calibrator.
3. The calibrator regulates the temperature to a safe value. The message “Please wait – device is being brought to a safe temperature” is displayed.
4. When the safe temperature has been reached, the message “You can now switch off the device” is displayed.
5. Switch off the calibrator via the mains switch.
6. Disconnect the calibrator from mains power if no further testing is required.
7. Unplug the power cord from the wall outlet.
8. Clean the calibrator after use, see Section 11.3.

5. User Interface

5.1 Main Window

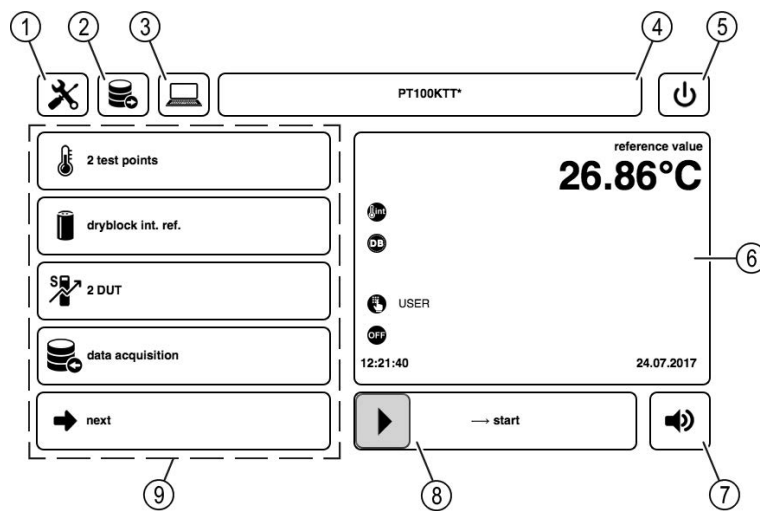









Figure 16: Main Window

Ref	Function	Description
1	Calibrator Setup	Tap the  icon to open the “Calibrator Setup” window. The calibrator settings can be change. See Section 7.
2	Measurement Logs	Tap the  icon to open the “Select Log Data” window. Saved measurement logs can be selected and viewed. See Section 9.
3	Remote Control	Enables Internet communication.
4	Test Task	Tap this area to open the “Select Test Task” window. Saved test tasks can be selected. New test tasks can also be created. See Section 6.1.
5	Shutdown	Tap the  icon to shutdown the calibrator. See Section 4.4.
6	Display Range	This window shows the reference temperature, set point temperature and additional information related to the selected test task. See Section 5.2.

Ref	Function	Description
7	Alarm Signal	The alarm signal can be muted  , or unmuted  . Use the “Alarm settings” window to define under what criteria the alarm signal is activated. See Section 6.2.6.
8	Start / Stop Slider	The start / stop slider is used to start  or end  the testing process.
9	Configuration Range	Tap this area to open the “Configuration range” window. Tap the  icon to open additional options.

5.2 Display Range

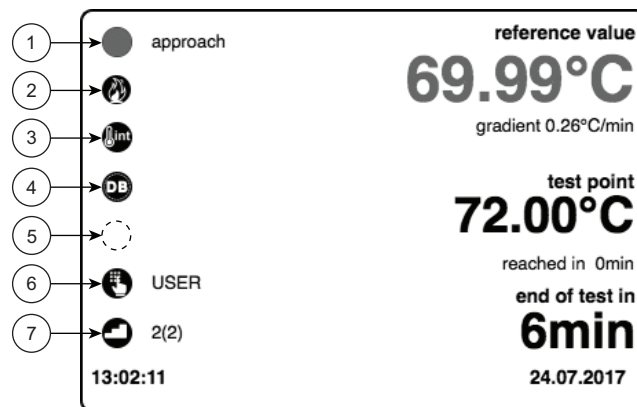































Figure 17: Display Range Window





Ref	Icon Group	Icon	Description
1	Status	  	Status of reference sensor and DUT.
2	Controller		Heating
			Cooling
			Stable with standard deviation.
			Controller off.
3	Reference Sensor		Internal reference sensor.
			External reference sensor.

Ref	Icon Group	Icon	Description
4	Function		Micro bath
			Tub insert
			Dry block
			Infrared
			Surface
			Reference thermometer.
5	Alignment		Factory settings.
			Customer specific settings.
6	Data Acquisition		Data acquisition disabled.
			User input data acquisition.
			Automatic data acquisition.
7	Operating Mode		Step/Cycle
			Switch test.

5.3 Toolbar

The following icons are used:

Icon	Name	Description
	Cancel / back	Return to the previous window. Changes are discarded without saving.
	Input Confirmation / Save	The selected value or setting is confirmed and saved.
	Configure	Switch to expert mode.
	Manage / Configure	The selected entry in the list is processed and the relevant window is displayed.
	Copy	The selected entry in the list is copied and the relevant window is displayed.
	Create New	A new entry is generated in the list and the relevant window is displayed.
	Delete	The selected entry in the list is deleted.

Icon	Name	Description
	Search	The list is searched for an entry and the result is displayed. Tapping the icon once again shows the entire list.
	Sort A-Z	The list is sorted alphabetically in ascending order.
	Sort Z-A	The list is sorted alphabetically in descending order.
	Export	The selected entry in the list is copied and the relevant window is displayed.

6. Test Task

In the main window, tap the “Test Task” area, see Figure 16 item 4.

6.1 Select Test Task

Select a test task and confirm your selection.

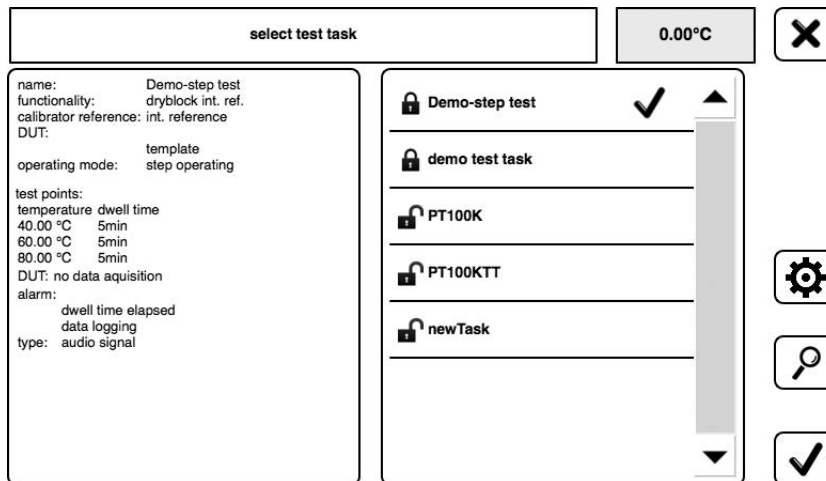



Figure 18: Select Test Task Window

6.2 Configure Test Task

1. Select the desired test task and tap the  icon.

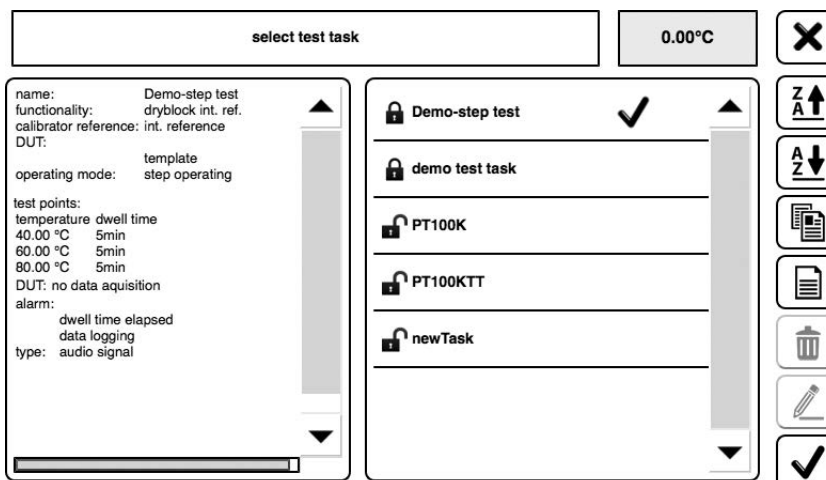





Figure 19: Select Test Task Window

Note: Protected  test tasks cannot be edited. Make a copy of the test task first.

2. Create a new test task  or edit  an unprotected test task.
3. Configure the test task with the required parameters.

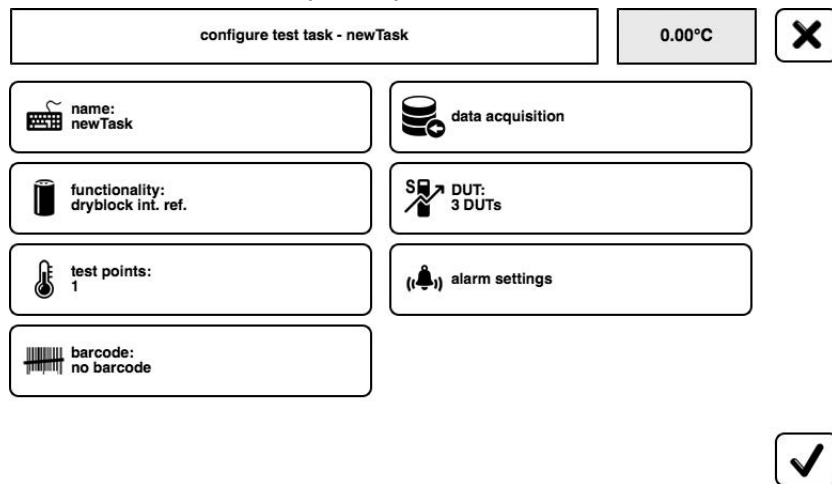



Figure 20: Configure Test Task Window

6.2.1 Name of Test Task

1. In the “Configure Test Task” window, see Figure 20, tap the “Name”  icon.
2. Enter the new name of the test task and confirm the input.

6.2.2 Data Acquisition

1. In the “Configure Test Task” window, see Figure 20, tap the “Data Acquisition”  icon.

6.2.2.1 Change the Name of the Measurement Log

1. Tap “Record name”.
2. Enter the new name of the measurement log and confirm the input.

6.2.2.2 Select the Data Acquisition Type

1. Tap “Data Acquisition”.
2. Select the desired type of data acquisition and confirm the selection.

6.2.3 Functionality



INFORMATION The selected function must be suitable for the calibrator type (Section 3.2) and the insert (Section 4.3).

1. In the “Configure Test Task” window, see Figure 20, tap the “Functionality”  icon.

6.2.3.1 Link Function to Test Task

1. Select the desired function and confirm the selection with the  icon.

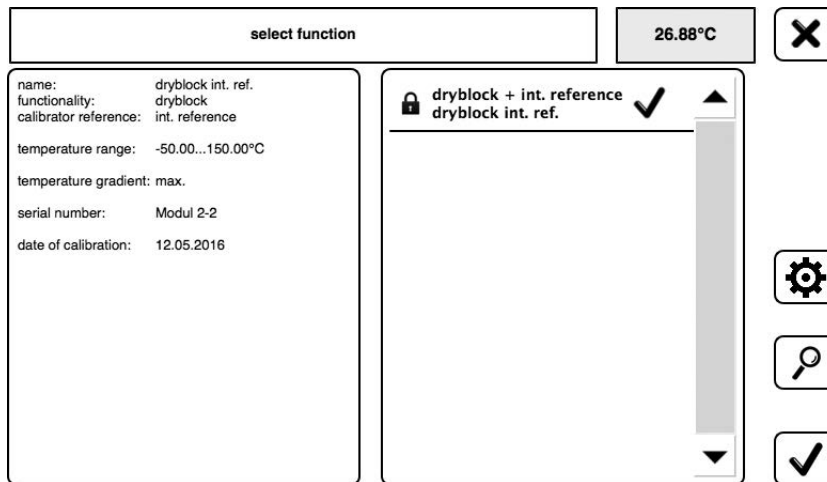

Figure 21: Link Function to Test Task

6.2.3.2 Configure the Function

1. Select the desired function and tap the  icon.

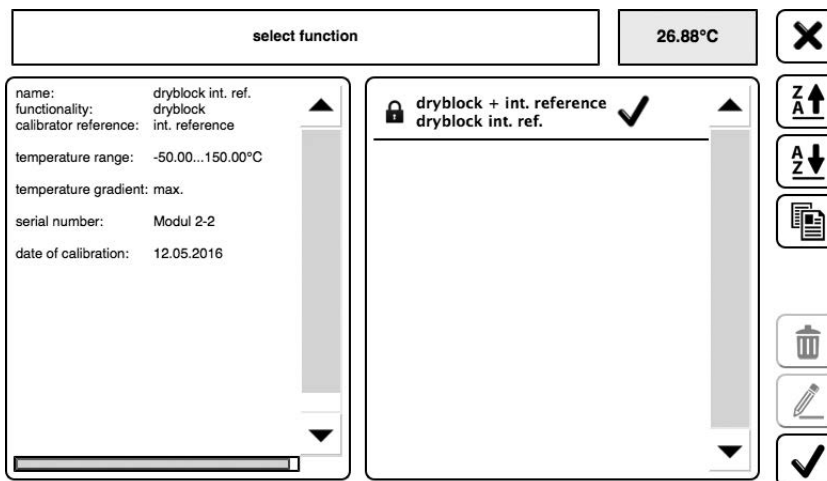



Figure 22: Select Function Window

Note: Protected  test tasks cannot be edited. Make a copy of the function first.

2. Tap the  icon.
3. Configure the function with the required parameters.

Alignment Types

The value pairs Ax to Nx are used for:

- Adjustment values measured by the customer
- Functions using the internal calibrator reference sensor (intRef).
- Functions using the external calibrator reference sensor (extRef).

The Callendar-Van Dusen coefficients are used for:

- Callendar-Van Dusen coefficients documented in the certificate.
- Functions using the external calibrator reference sensor (extRef).

Either the factory setting or a selected alignment method applies.

Stability Range

The stability range defines the maximum deviation from the set point which the calibrator should detect as stable. The smallest permitted value is 0.001.

6.2.4 Device Under Test (DUT)

1. In the “Configure Test Task” window, see Figure 20, tap the “DUT”  icon.

6.2.4.1 Link DUT to Test Channel

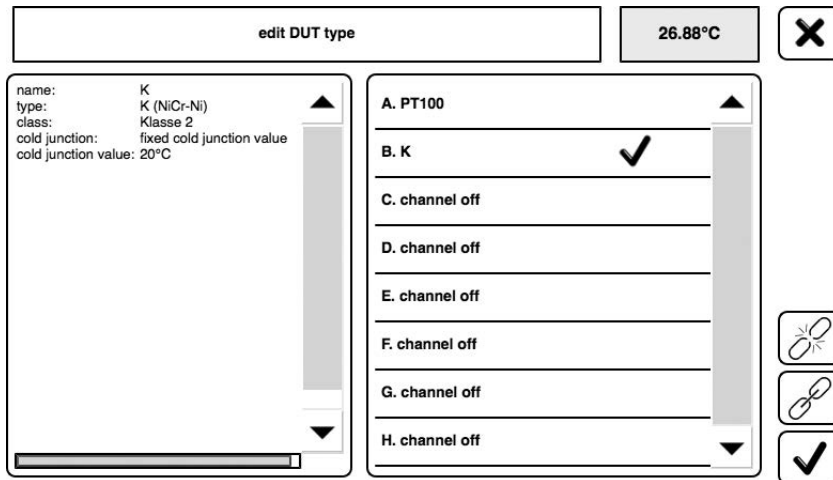





Figure 23: Link DUT to Test Channel Window

1. Tap the desired test channel.
2. Tap the  icon.
3. Select a DUT and confirm the selection.

6.2.4.2 Unlink the DUT from the Test Channel

1. Tap the desired test channel.
2. Tap the  icon.

6.2.4.3 Configure the DUT

1. Tap the desired test channel.
2. Tap the  icon.
3. Tap the  icon.

Note: Protected  DUT cannot be edited. Make a copy of the DUT first.

4. Tap the  icon.
5. Configure the DUT with the required parameters.

Switch Test

If you have selected automatic data acquisition (Switch Test) and switch as DUT type, you must set the type of the switch contact:

1. Tap “Switch Type Selector”.
2. Select the type of contact type of the switch:
 - a. NO (Normally Open), or
 - b. NC (Normally Closed)

3. Confirm the selection.

Waiting Time

The waiting time is a manually entered time delay to allow the DUT to stabilize before data acquisition.

Note: The waiting time is only used if user input was selected for data acquisition.

Gradient

The gradient is used when the internal measuring instrument or TTScan is selected for data acquisition. If the gradient falls below the set value, the DUT is stable.

Customer Specific Tolerance Value

Customer-specific tolerance values are used if the DUT has not been linked to a standard tolerance class or if a standard signal (current or voltage) is used.

1. Tap “Tolerance class”.
2. Select customer-specific and confirm the selection.
3. Tap “Tolerance value”.

$$\text{Tolerance value} = \text{Percent Value [\% of reading]} + \text{Constant Value [constant]}$$

4. Confirm the input.

6.2.5 Test Points



INFORMATION If the automatic data acquisition (Switch Test) is selected and the DUT type is set to switch, the test points “Starting Temperature”, “Test Area Beginning” and “Test Area End” are specified. “Test Point Calculation” is not available.

1. In the “Configure Test Task” window, see Figure 20, tap the “Test Points”  icon.

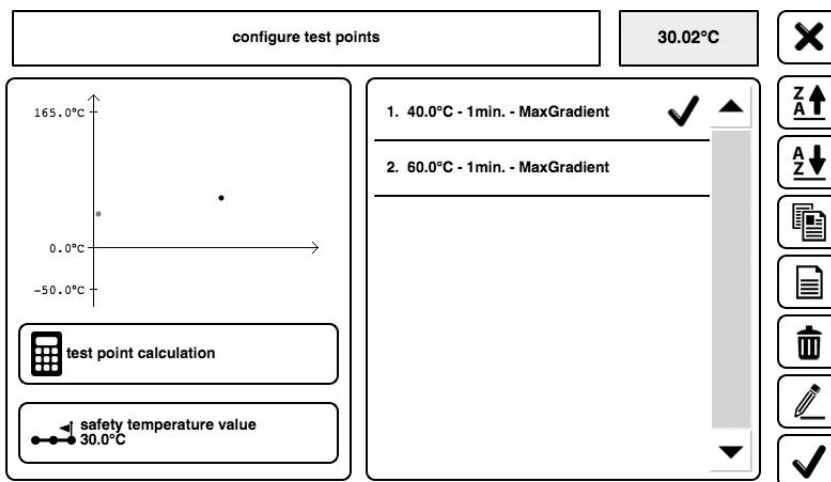



Figure 24: Configure Test Points Window

6.2.5.1 Create Test Points

1. Tap the  icon.
2. Enter temperature and dwell time and confirm the respective input.

6.2.5.2 Edit Test Points

1. Tap the  icon.

2. Change temperature and dwell time and confirm the new values.

6.2.5.3 Test Point Calculation

Use Test Point Calculation to automatically calculate the intervening test points between a specified first and last test point.

Note: When a parameter is changed, the other dependent parameters are automatically recalculated.

1. Tap the  icon.

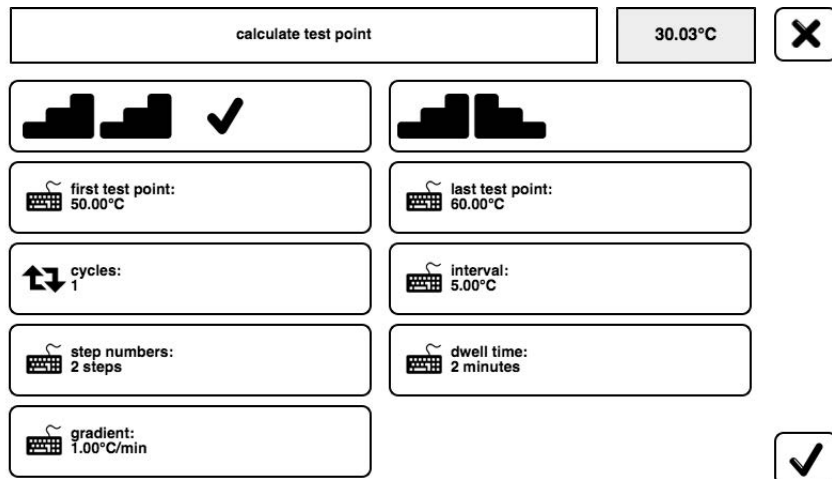



Figure 25: Calculate Test Point Window

Step, One-Sided

The one-sided step  calculates the intervening test points in succession from the first test point to the last test point.

Step, Two-Sided

The two-sided step  calculates the intervening test points in succession from the first test point to the last test point, then back to the first test point.

Define First and Last Test Points

1. Tap on the fields, enter the new values and confirm the input.
2. The intervening test points are automatically recalculated.
3. The screen returns to the previous window.

Cycles

Determines the number of cycles (repetitions) of a whole test sequence.

1. Tap the “Cycles”  icon.
2. Enter the new value and confirm the input.
3. The screen returns to the previous window.

Set Interval

For fixed intervals:

1. Tap the “Interval” field.
2. Enter the desired step width and confirm the input.
3. The number of steps are automatically calculated.

Note: If necessary, the last test point is also adjusted to match.

4. The screen returns to the previous window.

Defining the Number of Steps

Note: The total number of resulting test points is always one higher than the entered number of steps.

1. Tap the field “Number of Steps” to change the number of steps.
2. Enter the new value and confirm the input.
3. The number of steps is applied and the interval is automatically recalculated.

Set Dwell Time

1. Tap the field “Dwell Time”.
2. Enter the new value and confirm the input.
3. The screen returns to the previous window.

Set Gradient

1. Tap the field “Gradient”.
2. Enter the new value and confirm the input.
3. The screen returns to the previous window.

Behavior at Test End

Set the behavior of the calibrator at the end of the test.

1. Tap the field “Behavior at Test End”.
2. The “Select Behavior at Test End” window appears.

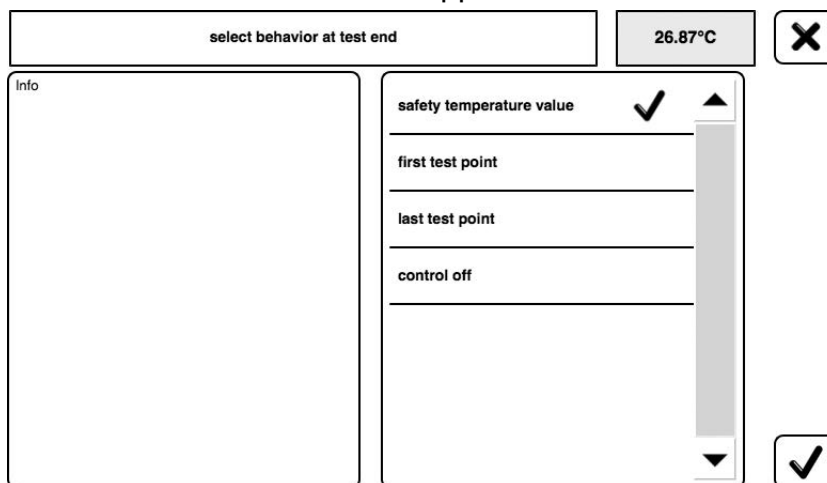



Figure 26: Behavior at Test End Window

3. Select the desired behavior and confirm the input.
4. The screen returns to the previous window.

Safety Temperature Value

Note: The “Safety Temperature Value” field is only visible if “Safety Temperature Value” has been selected as the behavior at the end of the test. See “Behavior at Test End” on page 32.

1. Tap the “Safety Temperature Value”  icon.
2. Enter the new value and confirm the input.
3. The screen returns to the previous window.

6.2.6 Alarm Settings

Use the alarm settings to configure how and when the calibrator activates the alarm signal.

1. In the “Configure Test Task” window, see Figure 20, tap the “Alarm Settings”  icon.

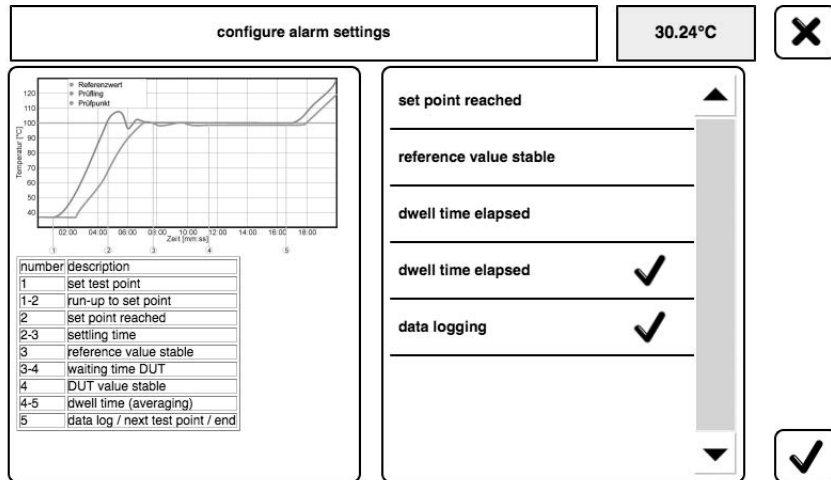



Figure 27: Alarm Settings Window

2. Select the desired entries from the list.
3. Confirm the selection.

6.2.7 Barcode

The calibrator can be configured to input a barcode and link it to a test task.

The barcode can be entered manually through the screen, or by using a compatible USB barcode scanner.

1. In the “Configure Test Task” window, see Figure 20, tap the “Barcode”  icon.
2. Select the desired entry from the list.
3. Confirm the selection.

7. Calibrator Setup

1. In the main window, see Figure 16, tap the “Calibrator Setup”  icon.

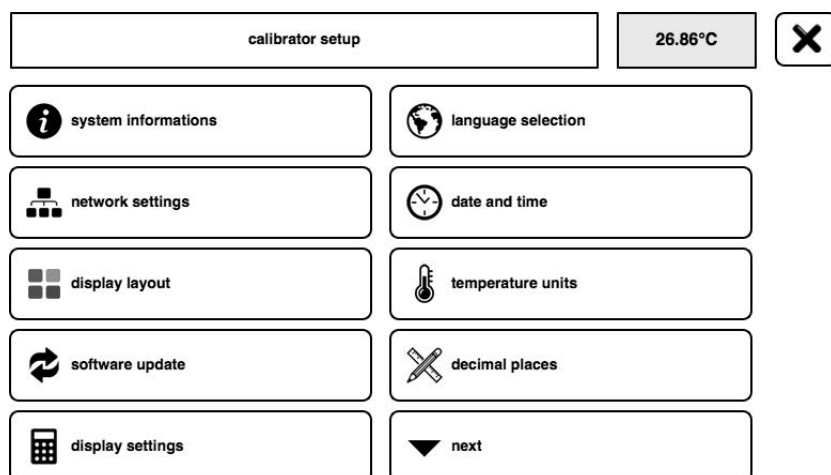

Figure 28: Calibrator Setup Window (Page 1 of 2)

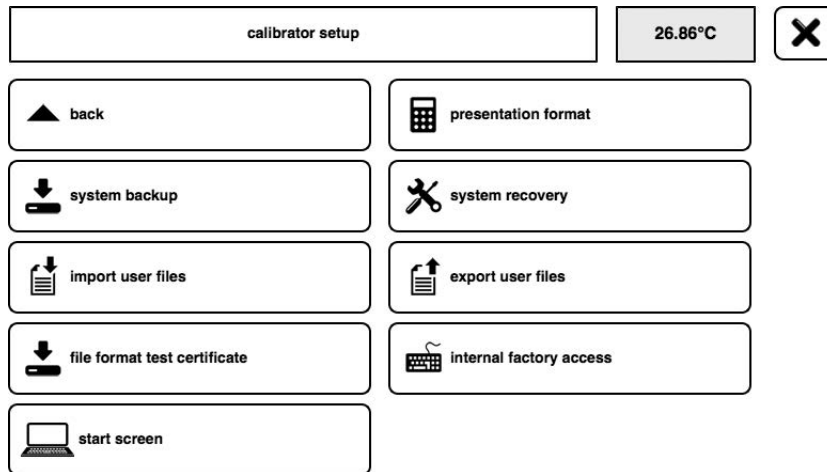



Figure 29: Calibrator Setup Window (Page 2 of 2)

Note: Use “next” and “back” to navigate between the configuration pages.

7.1 Configure Network

1. In the “Calibrator Setup” window, see Figure 28, tap the “Network Settings”  icon.
2. The network settings have the following two configuration options:

Network Mode	Description
DHCP	The IP address and subnet mask are automatically assigned.
Manual	The IP address and subnet mask are entered manually.

Note: If unsure, contact your network administrator.

7.2 Update Calibrator Software

Note: The calibrator software version is displayed in menu:

Calibrator Setup >> System Information

1. Download the latest calibrator software from: <https://qrco.de/drucksoftware>
2. Unpack the downloaded ZIP archive.
3. Save the file “update.tar” in the root directory of the USB flash drive.
4. Plug the USB flash drive into the calibrator.
5. In the “Calibrator Setup” window, see Figure 28, tap the “Software Update”  icon.
6. Follow the on-screen instructions.

7.3 Configure Presentation Format

1. In the “Calibrator Setup” window, see Figure 29, tap the “Presentation Format”  icon.

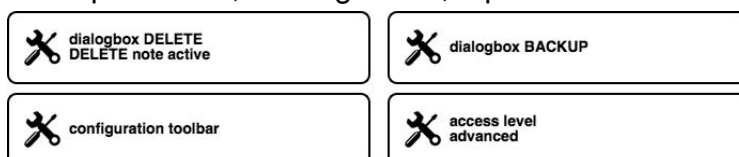

Figure 30: Presentation Format Configuration Window

The following configuration options for dialog boxes, the configuration toolbar and access level are available.

Dialogbox DELETE

Configure whether a warning message is displayed before an item is deleted.

Dialogbox BACKUP

Setting	Description
Note Settings	Configure whether to prompt for a system backup when the calibrator starts.
Backup Interval	Prompt for a system backup after a specified number of completed test tasks has elapsed.

Configuration Toolbar

Configures which entries are displayed in the configuration bar on the main screen. The order in which entries are displayed in the configuration bar can also be configured.

Access Level

Select an access level:

Access Level	Description
Standard	Test task parameters cannot be changed.
Advanced (Default)	Test task parameters can be changed after tapping the  icon.
Expert	Test task parameters can be changed without prior confirmation.

8. Testing Process / Calibration



HOT SURFACE The calibrator may become very hot when in operation. Touching hot parts can result in serious injuries.

Never touch the dry block, micro bath, inserts or the DUT at temperatures above 35 °C (95 °F) or below 10 °C (50 °F).

Allow the calibrator to cool before you remove the DUT, change the insert or switch off the calibrator.



INFORMATION For optimum performance, allow the calibrator to warm up for at least an hour before use.

8.1 Before Starting

Before starting the testing process, check that:

1. The calibrator has a suitable installation site and operational position. See Section 4.1.
2. The electrical connections have been made correctly. See Section 4.2.
3. The correct insert has been selected for the testing. See Section 4.3.
4. The insert is clean and dry.

Note: Ice and condensation can be removed from the insert by gently heating above 100 °C (212 °F).

5. The DUT is held securely in the calibrator.
6. The calibrator has sufficient structural stability.

8.2 Starting the Testing



INFORMATION During testing, all user controls except the Start/Stop slider and the Alarm Signal are disabled.

- Slide the start/stop slider completely to the right. The slider text changes from “start” to “stop”.



Figure 31: Start/Stop Slider - Starting the Test Task

- The test task is started.

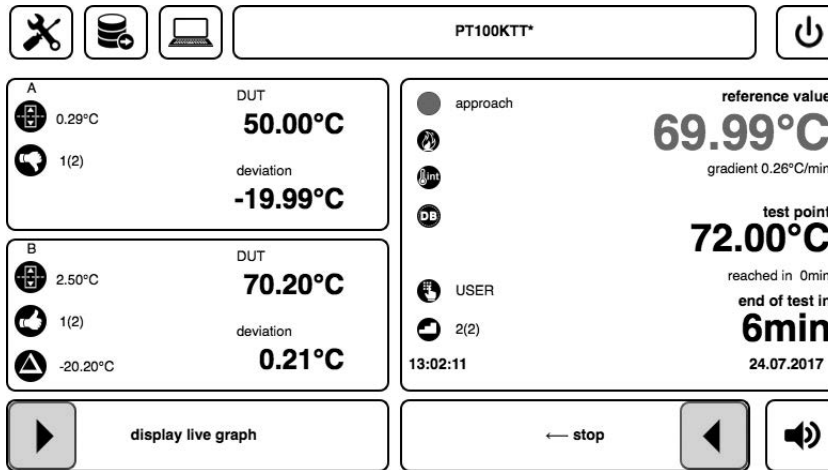

Figure 32: Example Test Task

- The status of the test task is displayed on the display range window. See Section 5.2.
- On successful test task completion, the following message is displayed.

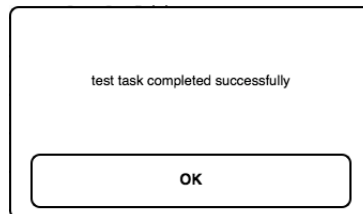

Figure 33: Test Task Completed Successfully Message

8.3 Canceling the Testing

- Slide the start / stop slider completely to the left. The slider text changes from “stop” to “start”.

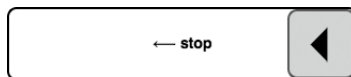

Figure 34: Start/Stop Slider - Stopping the Test Task

- The test task is aborted.
- The calibrator goes to the “Test End” temperature defined by the test task. See “Behavior at Test End” on page 32.

Note: Do not leave the calibrator unattended at high temperatures. See Section 4.4.2.

- Wait until the calibrator has cooled down sufficiently.

8.4 After the Testing

1. Allow the calibrator to cool to room temperature. See Section 4.4.2.
2. If necessary, drain the micro bath or tub insert with the syringe.
3. Clean the calibrator. See Section 11.3.

9. Measurement Log Management



1. In the main window, see Figure 16, tap the “Measurement Logs”  icon.



Figure 35: Measurement Logs Window

2. Select the desired measurement log and confirm the selection.
3. The “View Data Log” window appears.

Diagram

1. Tap the “Diagram”  icon.
2. A diagram with the set points and test points is displayed.

Table

1. Tap the “Table”  icon.
2. Select the desired channel and confirm the selection.

Export Log Data

1. Tap the “Export Log Data”  icon.
2. Follow the on-screen instructions.

Export All Log Data

1. Tap the “Export All Log Data”  icon.
2. The measurement log is exported in the desired file format.

Note: Select the desired export file format in menu:

Calibrator Setup >> File Format Test Certificate

10. Troubleshooting



PREVENT FAILURE Never open the calibrator. Critical parts or components may be damaged. Return the calibrator to Druck.

Refer to Table 4 for trouble shooting guide.

Table 4: Troubleshooting Guide

Problem	Possible Cause	Remedy
Calibrator touchscreen is not responsive to user input.	The calibrator is in an undefined state.	Turn off the calibrator, wait a few minutes, then restart.
Sensor break.	External reference sensor not properly connected.	Check connection.
	Cable break or short circuit.	
Fan not running.	The fan is defective or blocked.	Contact Druck Services.
	The thermal protection fuse has tripped.	
Set point temperature is not achieved.	Solid state relay is defective.	
	The heating / cooling element is defective.	
No display.	Controller is defective.	
Calibrator cannot be switched on.	Mains not available or fuses blown.	Check the mains supply and the fuses.
	Residual current circuit breaker has tripped due to moisture in the heating elements.	Contact Druck Services.

If you are unable to remedy the problem, immediately disconnect the calibrator to protect against unintended operation. Return the calibrator to Druck for repair.

11. Maintenance, Cleaning and Transportation

Before maintenance, cleaning and transportation, ensure:

1. The calibrator has cooled sufficiently. See Section 4.4.2.
2. The calibrator has been switched off and disconnected from the mains.

11.1 Maintenance



PREVENT FAILURE Never open the calibrator. Critical parts or components may be damaged. Return the calibrator to Druck.

The calibrator is maintenance-free and cannot be repaired by the user. In case of a defect, the calibrator must be returned to Druck, or approved service representative for repair.

For safe operation of the calibrator, the following checks must be carried out at regular intervals.

11.1.1 Before Use

1. Check the calibrator for damage.
2. For micro bath calibrators, check the filled height of the calibration liquid. See Section 4.3.5.8.

11.1.2 Annually

1. Visually inspect all parts of the calibrator for corrosion, wear and damage.
2. Have a trained technical person carry out an electrical safety inspection.

11.1.3 Recalibration

It is recommended to send the calibrator to Druck for recalibration after 36 months, or after a maximum of 500 operating hours, whichever is sooner.

11.1.4 Calibration Liquid

Calibration liquids become contaminated with age and with use. The speed at which this occurs depends greatly on the type of liquid and the usage behavior.

1. Replace contaminated or aged calibration liquid.

11.1.5 Magnetic Stirrer

The magnetic stirrer is subject to mechanical wear and tear during normal operation. The magnetic stirrer has a limited lifetime and requires periodic replacement. The fillet in the middle of the magnetic stirrer reduces the friction during the rotary movement. Once the fillet has worn, the stirring function can no longer be guaranteed because of the increased friction.

1. Check the fillet of the magnetic stirrer for wear and tear. Replace the magnetic stirrer if necessary.

11.1.6 Mains Fuses



WARNING Only use fuses of the same type.
For fuse specification, see Section 13.

The mains fuses of the calibrator are located on the front side and are integrated in the mains connection. If mains voltage is present, but the display is dark and the fan is not running, check the mains fuses. Replace the fuses if necessary.

1. Disconnect the mains connection cable from the calibrator.
2. Prise open the fuse compartment from the bottom with a fingernail or a flat screwdriver.
3. Remove the compartment with the fuses.
4. Check the fuses and replace any blown fuses.

Note: Always replace both fuses, even if only one has blown.

5. Fit the fuse compartment back in place and connect the mains connecting cable. See Section 4.2.

Note: Should the fuses blow repeatedly, there is probably a fault with the calibrator. Send the calibrator to Druck for repair.

11.2 Calibration

11.2.1 Recalibration

The calibrator is adjusted and tested with measuring equipment in accordance with recognized national standards prior to delivery.

The calibrator should, depending on the application situation, be inspected at appropriate intervals on the basis of ISO 10012.

It is recommended to send the calibrator to Druck for recalibration after 36 months, or after a maximum of 500 operating hours, whichever is sooner.

11.2.2 Adjustment



INFORMATION Only functions and DUTs marked with the  icon can be adjusted.

All test tasks or DUTs that use adjusted functions are affected by the adjustment.

In practice, the usage conditions during testing can vary from the measurement conditions at the time of the factory calibration.

Due to this, the calibrator offers the facility to store its own adjustment values. It is possible to have adjustments for user defined functions and DUTs.

The number of adjustment values can be freely selected. The calibrator can be directly aligned to an on-site standard thermometer, therefore achieving maximum display accuracy. It is not necessary to send the calibrator back to the manufacturer.

Note: The factory calibration is always retained. Adjustments can be removed at any time, resetting the calibrator back to the factory calibration.

Adjustment values can be entered:

- a. In the “Configuration Range” of the main window, see Figure 16 item 9, or
- b. In the DUT configuration window, see Section 6.2.4.3.

11.3 Cleaning

11.3.1 Exterior Chassis

Clean the calibrator with a dry or slightly damp lint-free cloth. Do not use sharp objects or aggressive agents for cleaning.

Ensure that your cleaning agent cannot be a source of danger from a reaction with parts of the calibrator or the materials inside. If unsure of clean agent compatibility, contact Druck Services.

11.3.2 Vent Grilles for Inlet Air



INFORMATION If the vent grilles become obstructed, the thermal protection fuse may trip. The thermal protection fuse is non-resettable. The calibrator cannot be used anymore. The calibrator must be returned to Druck for repair. Ensure that the grille openings are always kept clear.

The grille openings, see Figure 1 items 11 and 12, in the base of the calibrator must be cleaned at regular intervals. The cleaning interval depends upon on the air pollution at the installation site and the amount of use.

1. Clean the grille openings by vacuuming or brushing.

11.3.3 Inserts



INFORMATION Before a prolonged shutdown of the calibrator, remove the insert from the dry block or micro bath.

During normal operation, the inserts create small quantities of metal dust. This can result in an insert getting stuck in the dry block.

1. Remove the insert from the dry block with the aid of the sleeve exchange tool.
2. Clean the insert and the dry block at regular intervals.

11.3.4 Micro Bath

Before cleaning, the micro bath must be drained as much as possible using the draining syringe.

Observe the instructions in the safety data sheet of the calibration liquid.

11.3.4.1 Distilled Water

1. Remove the sensor cage from the tank.
2. Remove the magnetic stirrer with the aid of the magnetic lifter.
3. Thoroughly dry the micro bath, sensor cage, magnetic stirrer and the draining syringe.

11.3.4.2 Silicone Oil

1. Remove the sensor cage from the micro bath.
2. Remove the magnetic stirrer with the aid of the magnetic lifter.
3. Clean the micro bath, sensor cage, magnetic stirrer with water to which a generous amount of detergent has been added.
4. Remove the soapy water as much as possible using the draining syringe.
5. Thoroughly dry the micro bath, sensor cage, magnetic stirrer and the draining syringe.

11.4 Return Goods/Material Procedure

If the unit requires calibration or is unserviceable, return it to the nearest Druck Service Centre listed at: <https://qrco.de/bcPHml>.

Contact the Service Department to obtain a Return Goods/Material Authorization (RGA or RMA). Provide the following information for a RGA or RMA:

- Product (e.g. Dry PTC 700).
- Serial number.
- Details of defect/work to be undertaken.
- Include any error code(s).
- Operating conditions.

11.4.1 Safety Precautions



INFORMATION Service by unauthorized sources will affect the warranty and may not guarantee further performance.

You must inform Druck if the product has been in contact with any hazardous or toxic substance. The relevant COSHH or in the USA, MSDS, references and precautions to be taken when handling.

12. Decommissioning and Disposal

12.1 Before Decommissioning

Prior to decommissioning, ensure that:

1. The measurement set up is switched off and is in a safe de-energized state.
2. The calibrator and its accessories have completely cooled down. See Section 4.4.2.

12.2 Decommissioning

1. Remove all connected sensors and devices.
2. Switch off the calibrator and disconnect the mains plug.
3. Empty the micro bath of residual calibration liquid. See Section 11.3.4.

12.3 Disposal of Calibration Liquid



CAUTION Dispose of the calibration liquid in accordance with the Technical Safety Data Sheet.

12.4 Disposal of Calibrator

See “Marks and Symbols on the Equipment” on page ii for details of the Druck WEEE take-back scheme.

13. Specification

13.1 Shared Specification

Specification	Dry PTC and Liquid PTC Models
Display:	
Type	17.8 cm (7") Color Touch Screen
Resolution	0.1 / 0.01 / 0.001 °C / °F / K
Display units.	°C / °F / K
Display for sensor failure.	On-screen message.
Sensor failure behavior.	The control is switched off.
Excess temperature behavior.	Thermal fuses interrupt the power supply on excessive temperature inside the housing.
Environmental:	
Operating temperature range.	0°C to 50 °C (32°F to 122 °F)
Transportation and storage temperature.	-10 °C to 60 °C (14 °F to 140 °F)
Relative humidity.	< 80 % to 31 °C (87.8 °F), reducing linearly to 50 % at 40 °C (104 °F) (none condensing)
Operating conditions:	
- Location	Indoor use only.
- Altitude	Up to 2000 m (6561 ft)
- Operating position	Standing upright / vertically.
EMC	Tested in accordance with EN 61326-1, class A (Industrial environments)
Electrical Characteristics:	
PC interfaces	Ethernet, 3 × USB
Mains cable	H05VV-F 3 G 0.75 mm ² with angled protective contact plug and cold equipment plug. Length ~ 2 m (6.6 ft)
Safety	Over-voltage (Installation) Category II Pollution Degree 2 according to IEC 61010-1
Protective earth	Protective earth conductor (PE) must be available.

13.2 Dry PTC 200 Specification

Specification	Dry PTC 200	
Temperature range ^a	-55 °C to 200 °C (-67°F to 392 °F)	
Setting range	-60 °C to 200 °C (-76°F to 392 °F)	
Control sensor (switchable)	Internal	External
Hysteresis	± 0.25 °C (± 0.45 °F)	± 0.025 °C (± 0.045 °F)
Dry Block:		
Display accuracy	± 0.3 °C (± 0.54 °F)	± 0.2 °C (± 0.36 °F)
Temperature stability	± 0.01 °C (± 0.02 °F)	± 0.005 °C (± 0.009 °F)
Stabilization Time:		
With external reference sensor		
- to ± 0.05 °C (± 0.09 °F)	1 min	
- to ± 0.005 °C (± 0.009 °F)	5 min	
Dry Block:		
Borehole diameter	28 mm (1.10")	
Depth	150 mm (5.91")	
Homogeneous temperature zone	Bottom 40 mm (1.58") of the adaptor sleeve.	
Electrical Characteristics:		
Power supply	100 Vac to 240 Vac, 50/60 Hz ± 5 Hz	
Power consumption	~ 555 W	
Fuse	2 off 5 × 20 mm T6.3H250V	
Case:		
Dimensions		
- Width	210 mm (8.27")	
- Height + Handle	380+50 mm (15.0+2.0")	
- Depth	300 mm (11.8")	
- Weight	~ 15 kg (~ 33.1 lbs)	

a. At an ambient temperature of 20 °C (68 °F).

13.3 Dry PTC 700 Specification

Specification	Dry PTC 700	
Temperature range ^a	T _R to 700 °C (T _R to 1292 °F)	
Setting range	0 °C to 700 °C (32°F to 1292 °F)	
Control sensor (switchable)	Internal	External + Air Shield Insert
Hysteresis	± 0.12 °C (± 0.22 °F)	± 0.015 °C (± 0.027 °F)
Dry Block:		
Display accuracy	± 0.43 °C (± 0.77 °F)	± 0.27 °C (± 0.49 °F)
Temperature stability	± 0.1 °C (± 0.18 °F)	± 0.015 °C (± 0.027 °F)
Influence of load	± 0.18 °C (± 0.32 °F)	± 0.02 °C (± 0.04 °F)
Temperature distribution:		
- Axial	± 0.4 °C (± 0.72 °F)	± 0.4 °C (± 0.72 °F)
- Radial	± 0.04 °C (± 0.07 °F)	± 0.02 °C (± 0.04 °F)
Stabilization Time:		
With external reference sensor		
- to ± 0.05 °C (± 0.09 °F)	1 min	
- to ± 0.01 °C (± 0.02 °F)	5 min	
Dry Block:^b		
Borehole diameter	29 mm (1.14")	
Depth	150 mm (5.91")	
Homogeneous temperature zone	Bottom 40 mm (1.58") of the adaptor sleeve.	
Electrical Characteristics:		
Power supply	100 Vac to 115 Vac ± 10 %, 60 Hz ± 5 Hz 230 Vac ± 10 %, 50 Hz ± 5 Hz	
Power consumption	~ 1000 W	
Fuse	2 off 5 × 20 mm T10H250V	
Case:		
Dimensions		
- Width	210 mm (8.27")	
- Height + Handle	330+50 mm (13.0+2.0")	
- Depth	300 mm (11.8")	
- Weight	~ 10 kg (~ 22.1 lbs)	

a. The Dry PTC 700 can be operated up to 700 °C (1292 °F). It achieves optimum accuracy up to 660 °C (1220 °F). For temperatures between 660 °C (1220 °F) and 700 °C (1292 °F), Druck recommends the use of an external reference thermometer.

b. All values measured at 660 °C (1220 °F).

13.4 Liquid PTC 165(i) Specification

Specification	Liquid PTC 165(i)	
Control sensor (switchable)	Internal	External
Hysteresis	$\pm 0.25\text{ }^{\circ}\text{C}$ ($\pm 0.45\text{ }^{\circ}\text{F}$)	$\pm 0.025\text{ }^{\circ}\text{C}$ ($\pm 0.045\text{ }^{\circ}\text{F}$)
Air Shield (DB):		
Temperature range ^a	n/a	-30 °C to 160 °C (-30 °F to 320 °F)
Display accuracy	n/a	$\pm 0.07\text{ }^{\circ}\text{C}$ ($\pm 0.13\text{ }^{\circ}\text{F}$)
Temperature stability	n/a	$\pm < 0.001\text{ to }0.005\text{ }^{\circ}\text{C}$ ($\pm < 0.002\text{ to }0.009\text{ }^{\circ}\text{F}$)
Influence of load	n/a	$\pm 0.01\text{ }^{\circ}\text{C}$ ($\pm 0.02\text{ }^{\circ}\text{F}$)
Temperature distribution:		
- Axial	n/a	$\pm 0.06\text{ }^{\circ}\text{C}$ ($\pm 0.11\text{ }^{\circ}\text{F}$)
- Radial	n/a	$\pm 0.01\text{ }^{\circ}\text{C}$ ($\pm 0.02\text{ }^{\circ}\text{F}$)
Dry Block (DB):		
Temperature range ^a	-30 °C to 165 °C (-22 °F to 329 °F)	
Display accuracy	$\pm 0.27\text{ }^{\circ}\text{C}$ ($\pm 0.49\text{ }^{\circ}\text{F}$)	$\pm 0.1\text{ }^{\circ}\text{C}$ ($\pm 0.18\text{ }^{\circ}\text{F}$)
Temperature stability	$\pm 0.01\text{ }^{\circ}\text{C}$ ($\pm 0.02\text{ }^{\circ}\text{F}$)	$\pm 0.005\text{ }^{\circ}\text{C}$ ($\pm 0.009\text{ }^{\circ}\text{F}$)
Influence of load	$\pm 0.15\text{ }^{\circ}\text{C}$ ($\pm 0.27\text{ }^{\circ}\text{F}$)	$\pm 0.08\text{ }^{\circ}\text{C}$ ($\pm 0.14\text{ }^{\circ}\text{F}$)
Temperature distribution:		
- Axial	$\pm 0.2\text{ }^{\circ}\text{C}$ ($\pm 0.36\text{ }^{\circ}\text{F}$)	$\pm 0.2\text{ }^{\circ}\text{C}$ ($\pm 0.36\text{ }^{\circ}\text{F}$)
- Radial	$\pm 0.05\text{ }^{\circ}\text{C}$ ($\pm 0.09\text{ }^{\circ}\text{F}$)	$\pm 0.05\text{ }^{\circ}\text{C}$ ($\pm 0.09\text{ }^{\circ}\text{F}$)
Infrared (IR):		
Temperature range ^a	-35 °C to 165 °C (-31 °F to 329 °F)	
Display accuracy	$\pm 0.5\text{ }^{\circ}\text{C}$ ($\pm 0.9\text{ }^{\circ}\text{F}$)	
Stability	$\pm 0.02\text{ }^{\circ}\text{C}$ ($\pm 0.04\text{ }^{\circ}\text{F}$)	
Emission factor	0.9994	
Surface (SU):		
Temperature range ^a	-25 °C to 150 °C (-13 °F to 302 °F)	
Display accuracy	n/a	$\pm 1.0\text{ }^{\circ}\text{C}$ ($\pm 1.8\text{ }^{\circ}\text{F}$)
Stability	n/a	$\pm 0.15\text{ }^{\circ}\text{C}$ ($\pm 0.27\text{ }^{\circ}\text{F}$)
Micro Bath (Stirred), Direct Filling (LI):		
Temperature range ^a		
- Silicone oil 10 cSt	-35 °C to 155 °C (-31 °F to 311 °F)	
- Water	2 °C to 95 °C (-35.6 °F to 203 °F)	
Display accuracy	$\pm 0.24\text{ }^{\circ}\text{C}$ ($\pm 0.43\text{ }^{\circ}\text{F}$)	$\pm 0.19\text{ }^{\circ}\text{C}$ ($\pm 0.34\text{ }^{\circ}\text{F}$)
Temperature stability	$\pm 0.02\text{ }^{\circ}\text{C}$ ($\pm 0.04\text{ }^{\circ}\text{F}$)	$\pm 0.01\text{ }^{\circ}\text{C}$ ($\pm 0.02\text{ }^{\circ}\text{F}$)
Influence of load	$\pm 0.2\text{ }^{\circ}\text{C}$ ($\pm 0.36\text{ }^{\circ}\text{F}$)	$\pm 0.04\text{ }^{\circ}\text{C}$ ($\pm 0.07\text{ }^{\circ}\text{F}$)

Specification	Liquid PTC 165(i)	
---------------	-------------------	--

Temperature distribution:		
- Axial	$\pm 0.325 \text{ }^{\circ}\text{C}$ ($\pm 0.585 \text{ }^{\circ}\text{F}$)	$\pm 0.325 \text{ }^{\circ}\text{C}$ ($\pm 0.585 \text{ }^{\circ}\text{F}$)
- Radial	$\pm 0.08 \text{ }^{\circ}\text{C}$ ($\pm 0.14 \text{ }^{\circ}\text{F}$)	$\pm 0.08 \text{ }^{\circ}\text{C}$ ($\pm 0.14 \text{ }^{\circ}\text{F}$)

Micro Bath (Stirred), Tub Insert (TI):		
---	--	--

Temperature range ^a		
- Silicone oil 10 cSt	-35 °C to 155 °C (-31 °F to 311 °F)	
- Water	2 °C to 95 °C (-35.6 °F to 203 °F)	
Display accuracy	$\pm 0.28 \text{ }^{\circ}\text{C}$ ($\pm 0.50 \text{ }^{\circ}\text{F}$)	$\pm 0.20 \text{ }^{\circ}\text{C}$ ($\pm 0.36 \text{ }^{\circ}\text{F}$)
Temperature stability	$\pm 0.02 \text{ }^{\circ}\text{C}$ ($\pm 0.04 \text{ }^{\circ}\text{F}$)	$\pm 0.01 \text{ }^{\circ}\text{C}$ ($\pm 0.02 \text{ }^{\circ}\text{F}$)
Influence of load	$\pm 0.3 \text{ }^{\circ}\text{C}$ ($\pm 0.54 \text{ }^{\circ}\text{F}$)	$\pm 0.04 \text{ }^{\circ}\text{C}$ ($\pm 0.07 \text{ }^{\circ}\text{F}$)

Temperature distribution:		
- Axial	$\pm 0.35 \text{ }^{\circ}\text{C}$ ($\pm 0.63 \text{ }^{\circ}\text{F}$)	$\pm 0.35 \text{ }^{\circ}\text{C}$ ($\pm 0.63 \text{ }^{\circ}\text{F}$)
- Radial	$\pm 0.08 \text{ }^{\circ}\text{C}$ ($\pm 0.14 \text{ }^{\circ}\text{F}$)	$\pm 0.08 \text{ }^{\circ}\text{C}$ ($\pm 0.14 \text{ }^{\circ}\text{F}$)

Stabilization Time:		
----------------------------	--	--

With external reference sensor		
- to $\pm 0.05 \text{ }^{\circ}\text{C}$ ($\pm 0.09 \text{ }^{\circ}\text{F}$)	1 min	
- to $\pm 0.005 \text{ }^{\circ}\text{C}$ ($\pm 0.009 \text{ }^{\circ}\text{F}$)	5 min	

Micro Bath:		
--------------------	--	--

Borehole diameter	60 mm (1.14")	
Depth	170 mm (5.91")	
Homogeneous temperature zone	Bottom 40 mm (1.58") of the adaptor sleeve.	

Electrical Characteristics:		
------------------------------------	--	--

Power supply	100 Vac to 240 Vac, 50/60 Hz \pm 5 Hz	
Power consumption	~ 375 W	
Fuse	2 off 5 × 20 mm T6.3H250V	

Case:		
--------------	--	--

Dimensions		
- Width	210 mm (8.27")	
- Height + Handle	380+50 mm (15.0+2.0")	
- Depth	300 mm (11.8")	
- Weight	~ 13 kg (~ 28.7 lbs)	

a. At an ambient temperature of 20 °C (68 °F).

13.5 Liquid PTC 255(i) Specification

Specification	Liquid PTC 255(i)	
Temperature range	T_R to 255 °C (T_R to 491 °F)	
Setting range	0 °C to 255 °C (32°F to 491 °F)	
Control sensor (switchable)	Internal	External
Hysteresis	± 0.25 °C (± 0.45 °F)	± 0.025 °C (± 0.045 °F)
Air Shield (DB):		
Display accuracy	n/a	± 0.08 °C (± 0.14 °F)
Temperature stability	n/a	± 0.01 °C (± 0.02 °F)
Influence of load	n/a	± 0.025 °C (± 0.045 °F)
Temperature distribution:		
- Axial	n/a	± 0.08 °C (± 0.14 °F)
- Radial	n/a	± 0.05 °C (± 0.09 °F)
Dry Block (DB):		
Display accuracy	± 0.5 °C (± 0.9 °F)	± 0.25 °C (± 0.45 °F)
Temperature stability	± 0.05 °C (± 0.09 °F)	± 0.02 °C (± 0.04 °F)
Influence of load	± 0.45 °C (± 0.81 °F)	± 0.1 °C (± 0.18 °F)
Temperature distribution:		
- Axial	± 0.3 °C (± 0.54 °F)	± 0.3 °C (± 0.54 °F)
- Radial	± 0.15 °C (± 0.27 °F)	± 0.15 °C (± 0.27 °F)
Infrared (IR):		
Display accuracy	± 0.5 °C (± 0.9 °F)	
Stability	± 0.05 °C (± 0.09 °F)	
Emission factor	0.9994	
Surface (SU):		
Display accuracy	n/a	± 1.0 °C (± 1.8 °F)
Stability	n/a	± 0.2 °C (± 0.36 °F)
Micro Bath (Stirred), Direct Filling (LI):		
Display accuracy	± 0.46 °C (± 0.83 °F)	± 0.18 °C (± 0.32 °F)
Temperature stability	± 0.05 °C (± 0.09 °F)	± 0.04 °C (± 0.07 °F)
Influence of load	± 0.4 °C (± 0.72 °F)	± 0.1 °C (± 0.18 °F)
Temperature distribution:		
- Axial	± 0.15 °C (± 0.27 °F)	± 0.15 °C (± 0.27 °F)
- Radial	± 0.15 °C (± 0.27 °F)	± 0.15 °C (± 0.27 °F)
Micro Bath (Stirred), Tub Insert (TI):		
Display accuracy	± 0.53 °C (± 0.95 °F)	± 0.35 °C (± 0.63 °F)
Temperature stability	± 0.1 °C (± 0.18 °F)	± 0.05 °C (± 0.09 °F)

Specification	Liquid PTC 255(i)	
Influence of load	$\pm 0.4\text{ }^{\circ}\text{C}$ ($\pm 0.72\text{ }^{\circ}\text{F}$)	$\pm 0.1\text{ }^{\circ}\text{C}$ ($\pm 0.18\text{ }^{\circ}\text{F}$)
Temperature distribution:		
- Axial	$\pm 0.3\text{ }^{\circ}\text{C}$ ($\pm 0.54\text{ }^{\circ}\text{F}$)	$\pm 0.3\text{ }^{\circ}\text{C}$ ($\pm 0.54\text{ }^{\circ}\text{F}$)
- Radial	$\pm 0.15\text{ }^{\circ}\text{C}$ ($\pm 0.27\text{ }^{\circ}\text{F}$)	$\pm 0.15\text{ }^{\circ}\text{C}$ ($\pm 0.27\text{ }^{\circ}\text{F}$)
Micro Bath:		
Borehole diameter	60 mm (1.14")	
Depth	170 mm (5.91")	
Homogeneous temperature zone	Bottom 40 mm (1.58") of the adaptor sleeve.	
Electrical Characteristics:		
Power supply	100 Vac to 240 Vac, 50/60 Hz \pm 5 Hz	
Power consumption	~ 1000 W	
Fuse	2 off 5 \times 20 mm T10H250V	
Case:		
Dimensions		
- Width	210 mm (8.27")	
- Height + Handle	330+50 mm (13.0+2.0")	
- Depth	300 mm (11.8")	
- Weight	~ 8.5 kg (~ 18.7 lbs)	

13.6 Integrated Measuring Instrument

Note: Only applicable to models Liquid PTC 165i and Liquid PTC 255i.

Specification	Integrated Measuring Instrument	
Resistance Thermometer:		
Number of channels	2	
Connection	4 \times 4 mm safety sockets per channel	
Connection type	2, 3 or 4-wire	
Resistance range:		
- Pt100	0 to 400 Ω	
- Pt1000	0 to 4000 Ω	
Accuracy:		
- Pt100	$\pm 0.03\text{ }^{\circ}\text{C}$ ($\pm 0.05\text{ }^{\circ}\text{F}$)	
- Pt1000	$\pm 0.06\text{ }^{\circ}\text{C}$ ($\pm 0.11\text{ }^{\circ}\text{F}$)	
Thermocouple:		
Number of channels	2	
Connection	2 \times thermocouple (mini) sockets	

Specification	Integrated Measuring Instrument
Measuring range	-10 to 100 mV
Accuracy:	
- Cold junction	$\pm 0.3\text{ }^{\circ}\text{C}$ ($\pm 0.54\text{ }^{\circ}\text{F}$)
- Type K	$\pm 0.08\text{ }^{\circ}\text{C}$ ($\pm 0.14\text{ }^{\circ}\text{F}$)
- Type J	$\pm 0.07\text{ }^{\circ}\text{C}$ ($\pm 0.13\text{ }^{\circ}\text{F}$)
- Type N	$\pm 0.13\text{ }^{\circ}\text{C}$ ($\pm 0.23\text{ }^{\circ}\text{F}$)
- Type E	$\pm 0.06\text{ }^{\circ}\text{C}$ ($\pm 0.11\text{ }^{\circ}\text{F}$)
- Type T	$\pm 0.09\text{ }^{\circ}\text{C}$ ($\pm 0.16\text{ }^{\circ}\text{F}$)
- Type R	$\pm 0.78\text{ }^{\circ}\text{C}$ ($\pm 1.40\text{ }^{\circ}\text{F}$)
- Type S	$\pm 0.73\text{ }^{\circ}\text{C}$ ($\pm 1.31\text{ }^{\circ}\text{F}$)
Current Measurement:	
Number of channels	1
Connection	4 mm safety socket
Measuring range	0 to 24 mA
Accuracy	0.01 % full-scale
Voltage Measurement:	
Number of channels	1
Connection	4 mm safety socket
Measuring range	0 to 12 VDC
Accuracy	0.01 % full-scale
Switch Test:	
Number of channels	2
Transmitter Supply:	
Output current	24 mA (maximum)
Output voltage	24 VDC

13.7 Heating and Cooling Times

Note: The heating and cooling times are dependent on the parameters of the test task and the ambient conditions.

The following times are guide values only. They are measured at a room temperature of 23 °C (73.4 °F) and do not include transient effects.

13.7.1 Dry PTC 200

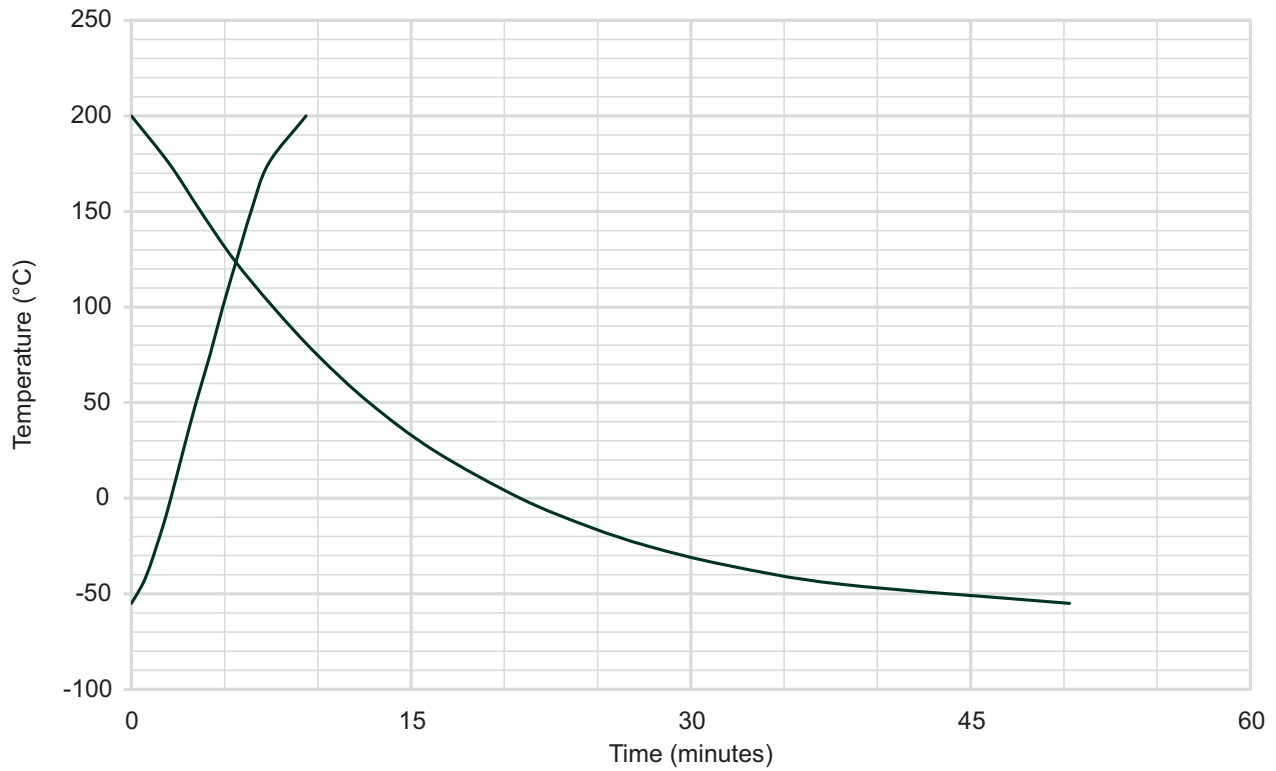

Figure 36: Dry PTC 200 Heating and Cooling Times

13.7.2 Dry PTC 700

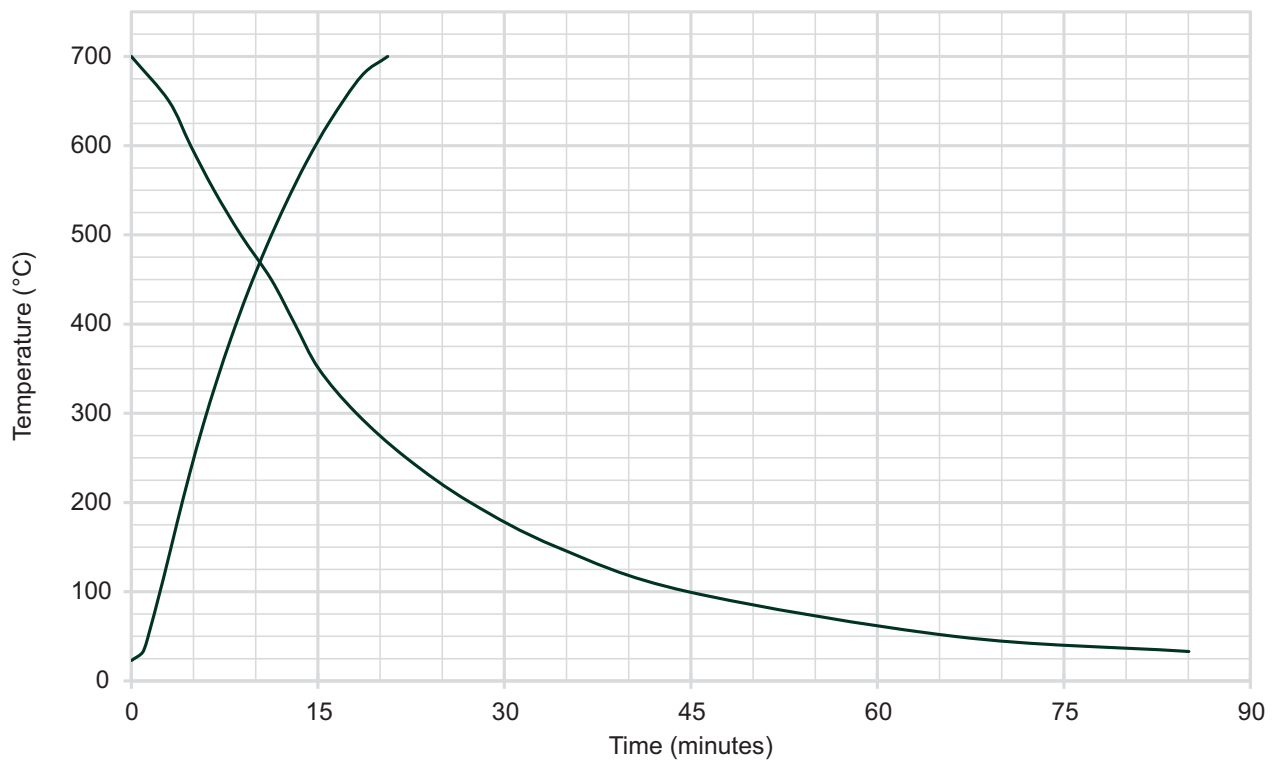

Figure 37: Dry PTC 700 Heating and Cooling Times

13.7.3 Liquid PTC 165(i)

13.7.3.1 Dry Block, Infrared and Surface Inserts

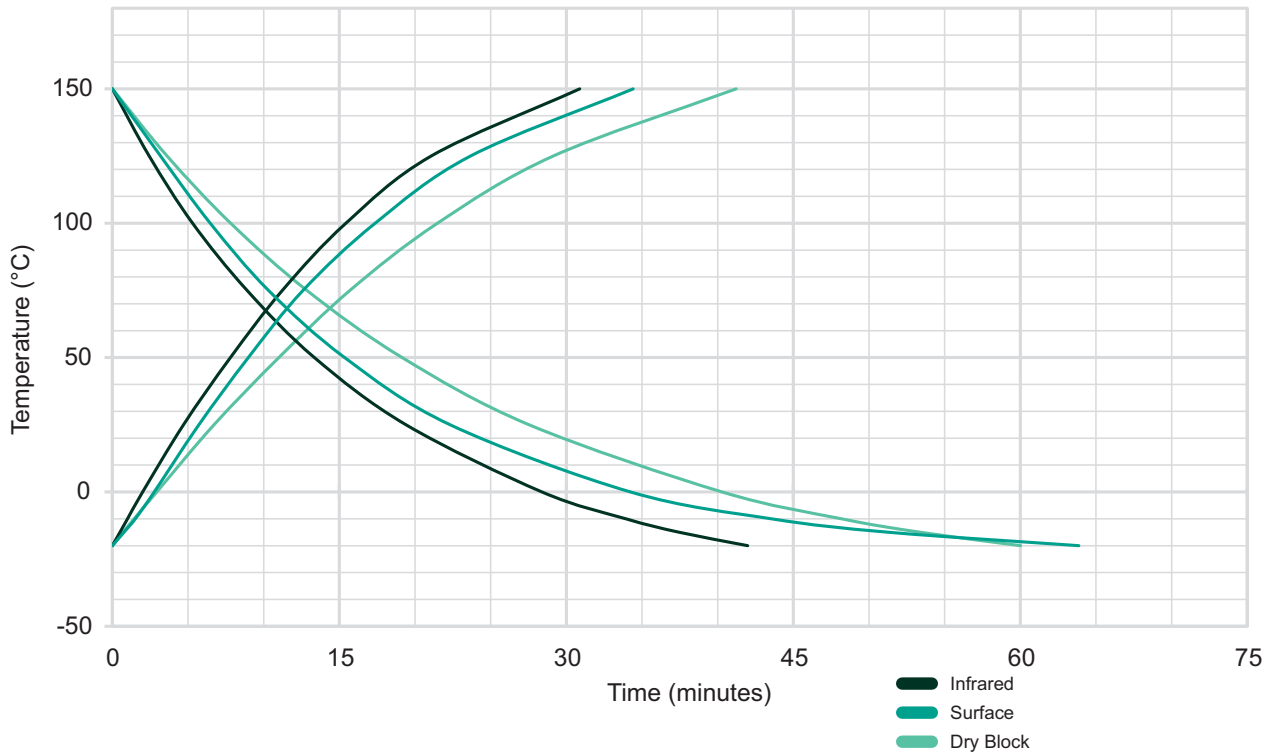

Figure 38: Liquid PTC 165(i) Heating and Cooling Times

13.7.3.2 Water and Silicone Oil

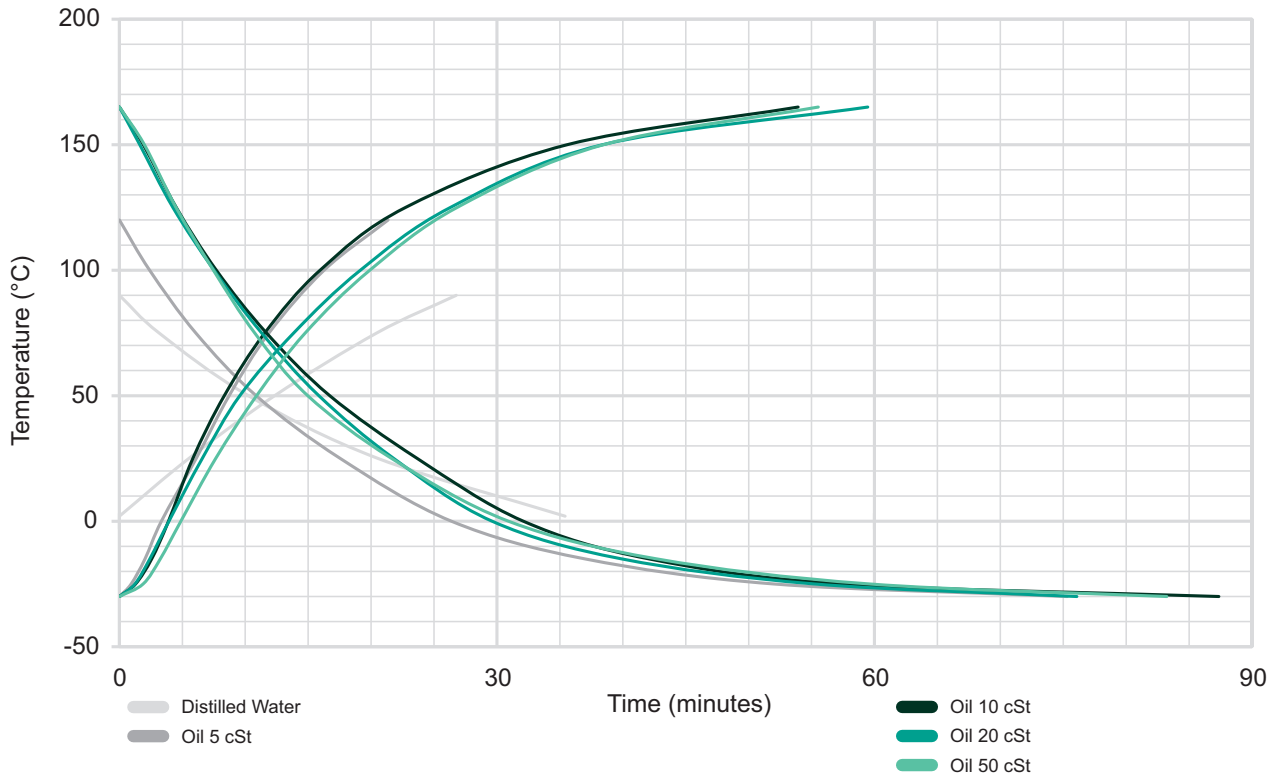

Figure 39: Liquid PTC 165(i) Heating and Cooling Times

13.7.4 Liquid PTC 255(i)

13.7.4.1 Dry Block, Infrared and Surface Inserts

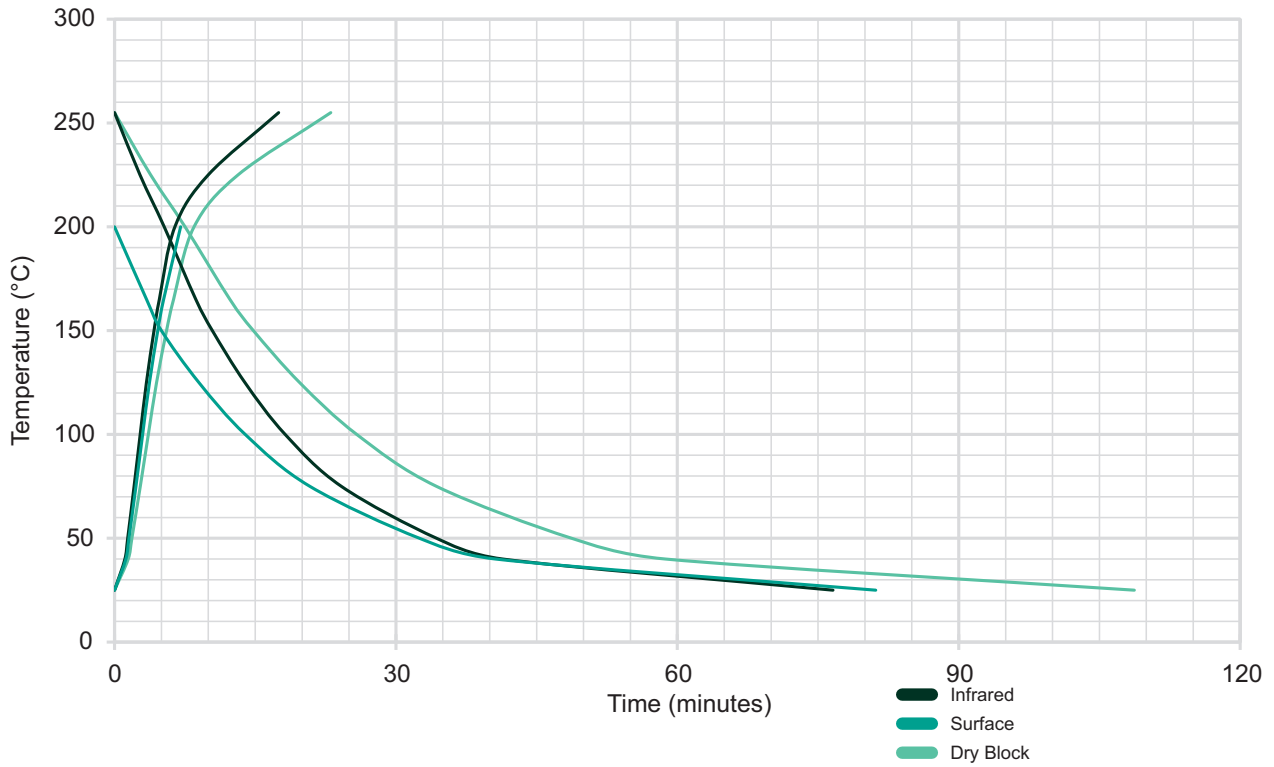

Figure 40: Liquid PTC 255(i) Heating and Cooling Times

13.7.4.2 Water and Silicone Oil

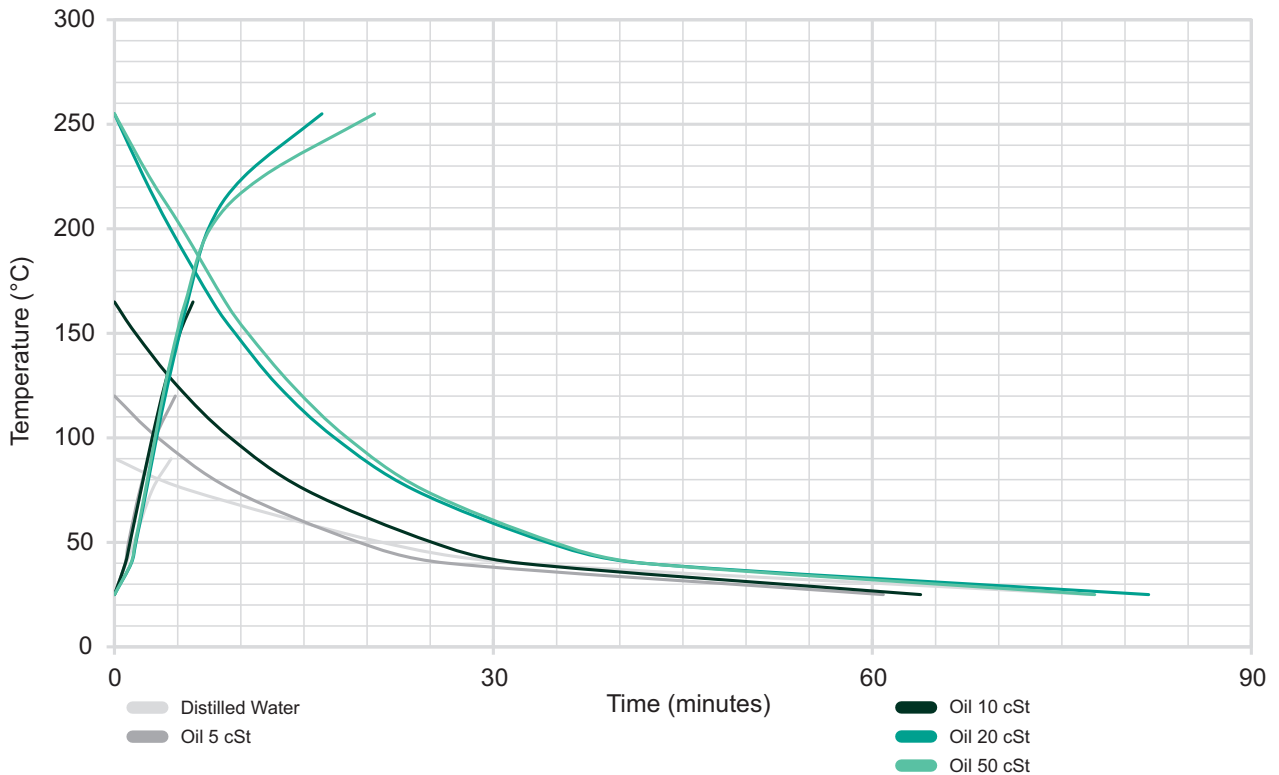

Figure 41: Liquid PTC 255(i) Heating and Cooling Times

Office Locations



Services and Support Locations

