

# Sentinel LNG

*Ultrasonic Flowmeter for Liquefied Natural Gas*  
User's Manual





Flow



# Sentinel LNG

*Ultrasonic Flowmeter for Liquefied Natural Gas*

User's Manual

910-286 B  
August 2021

[panametrics.com](http://panametrics.com)

Copyright 2021 Baker Hughes company.

This material contains one or more registered trademarks of Baker Hughes Company and its subsidiaries in one or more countries. All third-party product and company names are trademarks of their respective holders.

[no content intended for this page]

---

## Information Paragraphs

- **Note** paragraphs provide information that provides a deeper understanding of the situation, but is not essential to the proper completion of the instructions.
- **Important** paragraphs provide information that emphasizes instructions that are essential to proper setup of the equipment. Failure to follow these instructions carefully may cause unreliable performance.
- **Caution!** paragraphs provide information that alerts the operator to a hazardous situation that can cause damage to property or equipment.
- **Warning!** paragraphs provide information that alerts the operator to a hazardous situation that can cause injury to personnel. Cautionary information is also included, when applicable.

## Safety Issues

**WARNING!** It is the responsibility of the user to make sure all local, county, state and national codes, regulations, rules and laws related to safety and safe operating conditions are met for each installation.

## Auxiliary Equipment

### Local Safety Standards

The user must make sure that he operates all auxiliary equipment in accordance with local codes, standards, regulations, or laws applicable to safety.

### Working Area

**WARNING!** Auxiliary equipment may have both manual and automatic modes of operation. As equipment can move suddenly and without warning, do not enter the work cell of this equipment during automatic operation, and do not enter the work envelope of this equipment during manual operation. If you do, serious injury can result.

**WARNING!** Make sure that power to the auxiliary equipment is turned OFF and locked out before you perform maintenance procedures on the equipment.

### Qualification of Personnel

Make sure that all personnel have manufacturer-approved training applicable to the auxiliary equipment.

### Personal Safety Equipment

Make sure that operators and maintenance personnel have all safety equipment applicable to the auxiliary equipment. Examples include safety glasses, protective headgear, safety shoes, etc.

### Unauthorized Operation

Make sure that unauthorized personnel cannot gain access to the operation of the equipment.



**Chapter 1. Features and Capabilities**

- 1.1 Overview .....1
  - 1.1.1 Applications .....1
  - 1.1.2 Advantages .....1
  - 1.1.3 Meter Components .....1
  - 1.1.4 Name and Specification Plate .....3
- 1.2 Theory of Operation .....3
  - 1.2.1 Transit-Time Method .....4
  - 1.2.2 Transducers .....4
  - 1.2.3 Multipath Design .....5
  - 1.2.4 Flow Ranges .....5
- 1.3 Specifications .....5
  - 1.3.1 Operation and Performance .....5
  - 1.3.2 Meter Body .....6
  - 1.3.3 Electronics .....8
  - 1.3.4 Ordering Information .....9
- 1.4 Disclaimer .....12
- 1.5 Warnings and Cautions .....12

**Chapter 2. Installation**

- 2.1 Installation Guidelines .....15
- 2.2 Bill of Materials .....15
- 2.3 Mechanical Installation .....16
  - 2.3.1 Location .....16
  - 2.3.2 Installation Precautions .....17
  - 2.3.3 Installing the System .....17
  - 2.3.4 Guidelines for Installing Pipe Insulation .....18
- 2.4 Making Electrical Connections .....19
  - 2.4.1 Removing the Covers .....20
  - 2.4.2 Cable Tie-Down Posts .....20
  - 2.4.3 Wiring the Line Power .....22
  - 2.4.4 Wiring the Serial Port .....24
  - 2.4.5 Wiring the Modbus Communications Line (Optional) .....24
  - 2.4.6 Wiring the Alarm Relay .....25
  - 2.4.7 Wiring the 4-20mA Analog Inputs (Optional) .....26
  - 2.4.8 Wiring the Frequency Output .....30
  - 2.4.9 Wiring the 4-20 mA Analog Output .....31

**Chapter 3. General Programming**

- 3.1 Introduction .....37
- 3.2 Keypad Features .....37
  - 3.2.1 Indicator Lights .....38
  - 3.2.2 The Magnetic Stylus .....38
- 3.3 Program Menu Options .....39
  - 3.3.1 Channel Program .....39
  - 3.3.2 Composite Program .....39
  - 3.3.3 Advanced Program .....39
- 3.4 Unlocking and Locking .....40
  - 3.4.1 Unlocking the Sentinel LNG .....40
  - 3.4.2 Locking the Sentinel LNG .....41
- 3.5 Setting Security .....42
  - 3.5.1 Edit Passcodes .....42
  - 3.5.2 Security Timeout .....42
  - 3.5.3 Set Security .....42

3.6	Channel Programming	43
3.6.1	Activating a Channel/Path/CHX (Status)	43
3.6.2	Entering Fluid Data (Not supported at this time)	44
3.6.3	Entering Signal Parameters	44
3.6.4	Entering Error Limits	46
3.7	Composite Programming	47
3.7.1	Entering Fluid Type	47
3.7.2	Entering Signal Parameters	48
3.7.3	Setting Up Input Data Feeds	48
3.7.4	Setting Up API	49
3.8	Configuration	50
3.9	Inputs/Outputs	51
3.9.1	Analog Outputs	51
3.9.2	Frequency/Totalizers	51
3.9.3	Alarms	53
3.9.4	Analog Inputs (Additional Option)	54
3.9.5	RTD (Additional Option)	55
3.10	Display	55
3.11	Calibration	55
3.12	User Security	56
3.12.1	Edit Passcodes	56
3.12.2	Security Timeout	56
3.12.3	Set Security	56
3.13	Factory Status	56

**Chapter 4. Advanced Programming**

4.1	Entering Transducer Parameters	57
4.1.1	Clamp-On Transducers	57
4.1.2	Other Transducers	57
4.1.3	Wetted Transducers	58
4.2	Entering Path Data	59
4.3	Entering Signal Parameters	59
4.4	Entering the Meter Correction (K) Factor	60
4.5	Entering Pipe Parameters	62
4.6	Entering the Pipe Material	63
4.7	Entering Pipe Lining Data	63

**Chapter 5. Using PanaView**

5.1	Introduction	65
5.2	Wiring the RS232 Interface	65
5.3	Establishing Communications with Panaview™	65
5.3.1	Adding a Communications Port	65
5.3.2	Adding the Sentinel LNG to the Communications Port	67
5.4	Meter Security	71
5.5	Meter Properties	71
5.6	Program Menu	72
5.6.1	Status Setup	73
5.6.2	Transducer Setup	73
5.6.3	Fluid Setup	78
5.6.4	Path Setup	84
5.6.5	Signal Setup	85
5.6.6	K Factor Setup	85
5.6.7	Error Limits Setup	86



5.7	Composite Programs	87
5.7.1	Pipe Setup	87
5.7.2	Fluid Setup	93
5.7.3	Signal Setup	97
5.7.4	K Factors Setup	97
5.7.5	Weight Factors Setup	102
5.7.6	Inputs Setup	102
5.7.7	API Setup	110
5.8	Configuration Menu	116
5.8.1	Units Setup	116
5.8.2	Communication Setup	117
5.8.3	Reset Totals	125
5.8.4	Totalizer Errors	126
5.9	Input/Output Menu	126
5.9.1	Analog Outputs Setup	127
5.9.2	Frequency/Totals Setup	129
5.9.3	Alarms Setup	137
5.9.4	Slot 1 Setup	146
5.9.5	Slot 2 Setup	153
5.10	Display Menu	153
5.10.1	Views Setup	153
5.10.2	Contrast and Backlight	157
5.10.3	Display Mode Setup	157
5.11	Calibrate Menu	158
5.12	User Menu	160
5.12.1	Edit Passcodes	160
5.12.2	Set Security	161
5.13	Factory Menu	162
5.13.1	Checking Versions	162
5.13.2	Confirming Meters	164

**Chapter 6. MODBUS Communications**

6.1	Introduction	167
6.2	Setting Up MODBUS Communications	167

**Chapter 7. HART Communications**

7.1	Introduction	173
7.2	Wiring the HART Interface	173
7.3	Flowmeter Software Setup	174
7.4	Product Interfaces	174
7.4.1	Process Interface	174
7.4.2	Host Interface	175
7.5	Device Variables	175
7.6	Dynamic Variables	179
7.7	Status Information	179
7.7.1	Device Status	179
7.7.2	Extended Device Status	179
7.7.3	Additional Device Status	180
7.8	Universal Commands	181
7.9	Common-Practice Commands	181
7.9.1	Supported Common Practice Commands	181
7.9.2	Burst Mode Commands	182
7.9.3	Catch Device Variable Command	182
7.10	Device-Specific Commands	183
7.10.1	Command 181 (0xB5): Clear Totals	183
7.11	Tables	184
7.11.1	HART Engineering Units	184

7.12	Performance	186
7.12.1	Sampling Rate	186
7.12.2	Power-Up	186
7.12.3	Device Reset	186
7.12.4	Self-Test	187
7.12.5	Command Response Delay	187
7.12.6	Busy and Delayed Response	187
7.12.7	Long Messages	187
7.12.8	Non-Volatile Memory	187
7.12.9	Operating Modes	187
7.12.10	Write Protection	187
7.12.11	Write Protect Switch	187
7.12.12	Totals Protect Switch	187
7.13	Capability Checklist	187
7.14	Default Configuration	189
7.15	Revision History	189

**Chapter 8. Maintenance**

8.1	Calibration	191
8.1.1	Updating Sentinel LNG Instrument Software	191
8.1.2	Checking the Meter Software	195
8.1.3	Trimming 4-20 mA Using the Keypad	196
8.2	Spare Parts	196
8.3	Installing Replacement Parts	196

**Chapter 9. Troubleshooting**

9.1	Introduction	197
9.2	Error Codes	197
9.2.1	E0: No Error	197
9.2.2	E1: Low Signal	197
9.2.3	E2: Soundspeed Error	197
9.2.4	E3: Velocity Range Error	197
9.2.5	E4: Signal Quality Error	198
9.2.6	E5: Amplitude Error	198
9.2.7	E6: Cycle Skip, Acceleration Error	198
9.2.8	E7: Analog Output Error	199
9.2.9	E13: Settle Tracking AGC	199
9.2.10	E14: Tracking Seek Mode	199
9.2.11	E15: Active Tw Error	199
9.2.12	E16: Totalizer Overflow Error	199
9.2.13	E17: Temperature Input Error	199
9.2.14	E18: Pressure Input Error	199
9.2.15	E19: Density Input Error	199
9.2.16	E20: Special Input Error	200
9.2.17	E21: API Error	200
9.2.18	E22: Degraded Performance Error	200
9.2.19	E30: Channel Disabled	200
9.3	Displaying Diagnostic Parameters	200
9.4	Fluid and Pipe Problems	202
9.4.1	Fluid Problems	202
9.4.2	Pipe Problems	203
9.5	Transducer Problems	203
9.5.1	Clamp-on Transducer Problems	203
9.6	Audit Trail	204
9.6.1	Audit Log	204
9.6.2	Reading Audit Log Records	205
9.6.3	Formatting and Viewing Log Records	206
9.7	Uncertainty in Flow Rate for a Non-Insulated Meter	207

**Appendix A. Menu Maps**

**Appendix B. CE Mark Compliance and High Noise Areas**

B.1 Introduction ..... 219  
B.2 EMC Compliance ..... 219

**Appendix C. Data Records**

C.1 Site Data..... 221

**Appendix C. Service Record**

C.1 Introduction .....225  
C.2 Data Entry .....225  
C.3 Diagnostic Parameters .....226



# Chapter 1. Features and Capabilities

## 1.1 Overview

The Panametrics Sensing **Sentinel LNG** is an ultrasonic liquid flow transmitter that includes a multipath ultrasonic flowmeter. The entire system is shipped fully assembled and preconfigured.

### 1.1.1 Applications

The **Sentinel LNG** is designed specifically for the custody transfer of liquified natural gas.

Liquified natural gas, or LNG, is natural gas (predominantly methane, CH<sub>4</sub>) that has been converted temporarily to liquid form for ease of storage or transport.

Liquified natural gas takes up about 1/600th the volume of natural gas in the gaseous state. It is odorless, colorless, non-toxic and non-corrosive. Hazards include flammability, freezing and asphyxia.

The liquefaction process involves removal of certain components, such as dust, acid gases, helium, water, and heavy hydrocarbons, which could cause difficulty downstream. The natural gas is then condensed into a liquid at close to atmospheric pressure (Maximum Transport Pressure set around 25 kPa/3.6 psi) by cooling it to approximately -162°C (-260°F).

### 1.1.2 Advantages

The **Sentinel LNG** features numerous unique advantages:

- 0.25% Accuracy
- Capable of handling cryogenic LNG temperatures, typically at -162°C (-260°F).
- Fast response electronics
- Advanced signal processing
- Fully welded on transducers' buffer rods, resulting in a fully-sealed system.
- Zero pressure drop
- Bi-directional flow capability
- Excellent low-end and high-end resolution
- Active Tw compensation, a compensation algorithm for temperature gradients within the ultrasonic transducer and buffer system.
- High turndown ratio
- Low sensitivity to many upstream flow disturbances
- Minimal maintenance
- Transducer replacement without the need for pipe shutdown or recalibration
- Removable/replaceable transducers

### 1.1.3 Meter Components

Figure 4 on page 13 shows the complete **Sentinel LNG** system and each of the items is described in Table 1 and Table 2 below.

No.	Component	Description	Qty
1	Meter Body	Measurement section of a <b>Sentinel LNG</b> System.	1
2	Name and Specification Plate	All pertinent information in a single location.	1
3	Transducer Holder Assembly	Device to support a transducer and provide a mounting point for the Insertion Mechanism.	4
4	Transducer	Flow sensor to transmit and receive ultrasonic waves.	4

No.	Component	Description	Qty
5	Cable Assembly - Transducer to Electronics Unit	Conductors assembled and rated for hazardous areas.	4
6	Explosion-Proof Junction Box	Housing for electrical connections in hazardous area.	4
7	Electronics Unit	Meter electronics equipment, including power supply, processing unit and communications.	1
8	External Conduits Connection	Location for power and communications connections. Cable glands are 3/4" NPT.	4
9	Nuts and Bolts	Hardware to hold flanges together.	AR

Component	Materials (ASTM)
Pipe Flanges and Fittings	Carbon Steel (A105 or A350 LF2*)
Pipe Sections	Carbon Steel (A106 Gr. B or A333 Gr. 6*)
Transducer Holder Parts	Stainless Steel 316/316L (A276)
TII Transducers	Titanium CP Gr. 2 (B348/B381) or Stainless Steel 316/316L (A276)
* A350 LF2 and A333 Gr. 6 are used for low temperature service and are specified by the customer.	

### 1.1.4 Name and Specification Plate

The location of the Sentinel LNG specification plate is shown in Figure 4 on page 13. Figure 1 below shows a blank plate. The specifications can be filled in by the user, for quick reference while using the manual.

Tag #:  
 Order String:  
  
 Assembly Date:  
 S/N:  
 PO#:  
 SO#:  
 Meter Size:  
 ID:  
 $Q_{min} / Q_{max}$ :  
 HF Output:  
 Storage Temp:  
 Oper. Temp:  
 Oper. Pressure:  
 Test Pressure:  
 Hygro Test Date:  
 Flange Class:  
 Dry Weight:  
 Meter Body Material:  
 Flange Material:  
 Body Design Code:  
 Flange Design Code:  
 Type Approval Number:  
 CE Flow Cell Mfg:  
 Mfg Serial No:  
 NoBo ident. No:

Figure 1: Sentinel LNG Data Plate

## 1.2 Theory of Operation

The Sentinel LNG Measurement System uses ultrasonic transit-time technology. A brief description of transit-time theory follows. For more information about the theory, and the use of Panametrics Sensing ultrasonic flowmeters for measuring flow, please refer to *Ultrasonic Measurements for Process Control* by L.C. Lynnworth (Academic Press, 1989)

### 1.2.1 Transit-Time Method

The transit time technique uses a pair of transducers, with each transducer alternately sending and receiving coded ultrasonic signals through the fluid. Figure 2 below shows the paths used in the Sentinel LNG. When the fluid is flowing, signal transit time in the downstream direction is shorter than in the upstream direction; the difference between these transit times is proportional to the flow velocity. The Sentinel LNG measures this very small time difference and, using various digital signal processing techniques combined with programmed pipe parameters, determines the flow rate and direction.

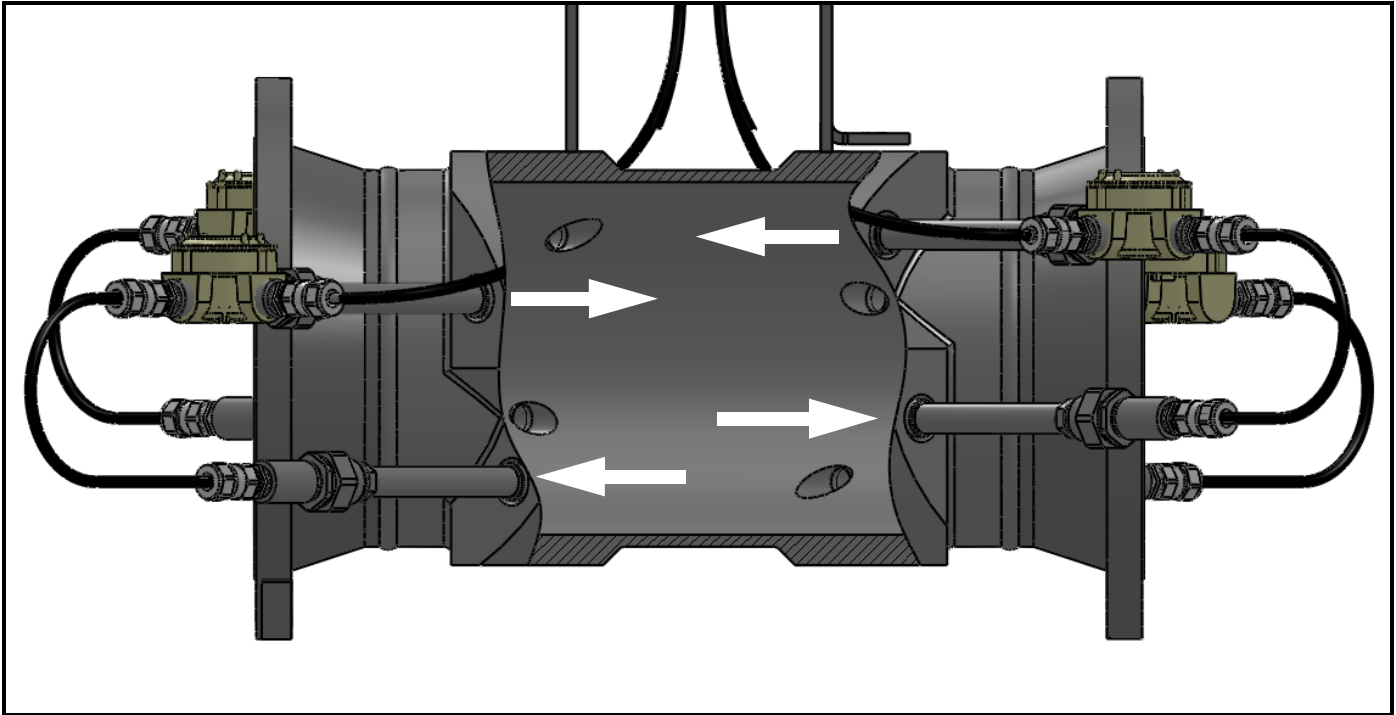

Figure 2: Path Configuration

### 1.2.2 Transducers

When in a transmit cycle, transducers convert electrical energy into ultrasonic pulses and then convert the ultrasonic pulses back to electrical energy when in a receive cycle. In other words, they act like loudspeakers when transmitting the signal and like microphones when receiving it. They perform the actual data transmission and collection, thus interrogating the flow.



### 1.2.3 Multipath Design

Multipath ultrasonic flowmeters are designed with more than one pair of transducers to interrogate the flow field in different locations and more accurately determine the actual flow rate. The Sentinel LNG Measurement System uses four measurement locations. These measurement paths are located across the meter body and tilted at an angle. The two measurement paths are orthogonal to each other (see Figure 2 on page 4).

### 1.2.4 Flow Ranges

Typical flow rates for 0.5 m (19.6 in) per second and 10 m (393 in) per second are listed below. The Sentinel LNG is a full bore meter and the flow range is a function of the pipe and not the meter itself.

		0.5 m/s	10 m/s	0.5 m/s	10 m/s	0.5 m/s	10 m/s
Nominal Diameter		1.69 ft/s	33 ft/s	1.69 ft/s	33 ft/s	1.69 ft/s	33 ft/s
in	mm	(m <sup>3</sup> /h)	(m <sup>3</sup> /h)	(GPM)	(GPM)	(BBL/h)	(BBL/h)
4	100	15	280	66	1230	94	1760
6	150	33	630	145	2770	207	3960
8	200	58	1130	255	4980	364	7120
10	250	91	1800	400	7900	573	11300
12	300	131	2500	580	11000	825	15700
14	350	179	3500	790	15400	1130	22000
16	400	233	4500	1030	19800	1470	28300
18	450	296	5700	1300	25100	1860	35900
20	500	365	7000	1600	30800	2300	44000
24	600	525	10000	2310	44000	3300	63000

## 1.3 Specifications

The system specifications for the Sentinel LNG Ultrasonic Liquid Flow Transmitter are divided into the following categories:

### 1.3.1 Operation and Performance

#### 1.3.1.1 Fluid Types

Liquified Natural Gas

#### 1.3.1.2 Flow Measurement

Correlation Transit Time mode

#### 1.3.1.3 Accuracy

< ± 0.20% of measured volume for flow rates between 2 and 30 ft/s (0.5 and 10 m/s).

#### 1.3.1.4 Zero Stability

< 0.007 ft/s

### 1.3.1 Operation and Performance (cont.)

#### 1.3.1.5 Process Temperature

-200° to +120°C

#### 1.3.1.6 Ambient Temperature

-40° to +60°C

#### 1.3.1.7 Storage Temperature

-40° to +80°C

### 1.3.2 Meter Body

#### 1.3.2.1 Path Configuration

4 path Robust Path Configuration™

#### 1.3.2.2 Meter Body Materials

- Stainless steel A182, Gr 304/304L
- Stainless steel A182, Gr 316/316L

Others on request.

#### 1.3.2.3 Flow Cells

4" (100 mm) to 24" (600 mm)

Others on request

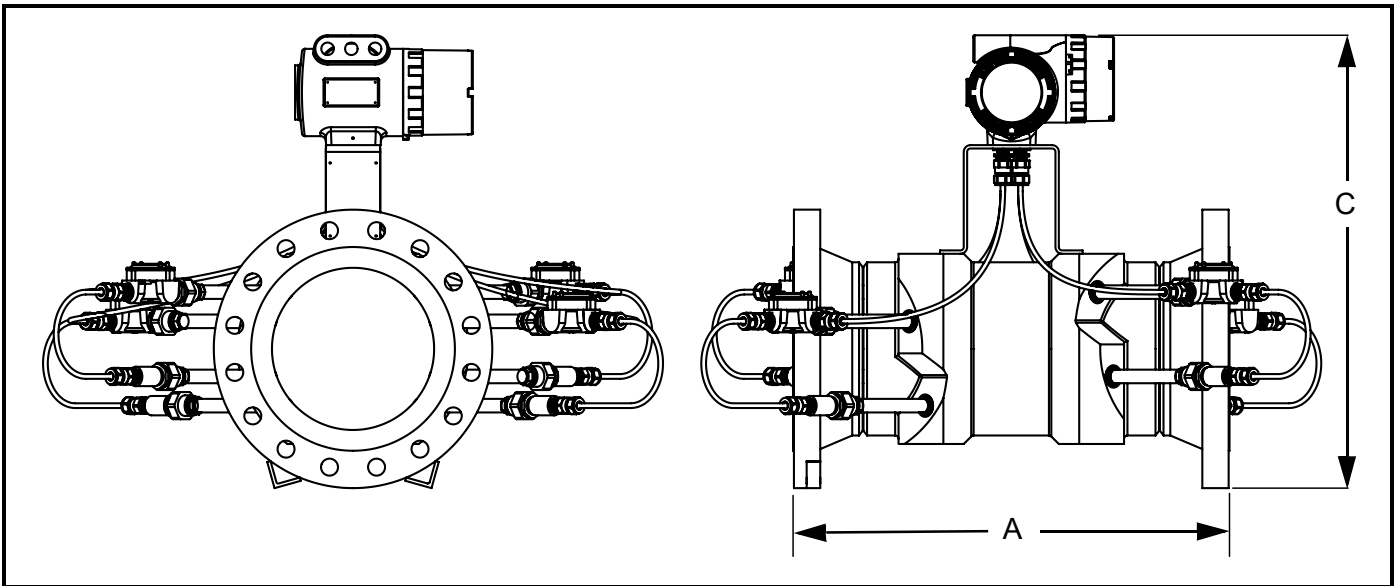

Figure 3: Flowcell Assembly

## 1.3.2.3 Flow Cells (cont.)

**Note:** Use Figure 3 on page 6 to identify the A and C measurements in Table 4 below.

Dimensions and Weights in English Units					Dimensions and Weights in Metric Units				
Diameter (inches)	Flange Weight (lb)	A (in)	C (in)	Weight (lb)	Diameter (inches)	Flange Weight (kg)	A (mm)	C (mm)	Weight (kg)
4	150	20	23.49	149	4	56	508	597	68
	300	20	23.99	176		112	508	609	80
	600	20	24.365	200		224	508	619	91
6	150	22	25.76	209	6	56	559	654	95
	300	24	26.51	265		112	610	673	120
	600	26	27.26	338		224	660	692	153
8	150	26	27.59	268	8	56	660	701	122
	300	28	28.34	343		112	711	720	156
	600	30	29.09	452		224	762	739	205
10	150	28	29.84	367	10	56	711	758	166
	300	30	30.59	487		112	762	777	221
	600	32	31.84	739		224	813	809	335
12	150	30	32.59	478	12	56	762	828	217
	300	32	33.34	681		112	813	847	309
	600	36	34.09	957		224	914	866	434
14	150	36	34.09	790	14	56	914	866	358
	300	38	35.09	1079		112	965	891	489
	600	40	35.465	1339		224	1016	901	607
16	150	38	36.84	989	16	56	965	936	449
	300	40	37.84	1348		112	1016	961	611
	600	42	38.59	1770		224	1067	980	803
18	150	38	37.84	1056	18	56	965	961	479
	300	40	39.34	1527		112	1016	999	693
	600	44	39.965	2076		224	1118	1015	942
20	150	46	41.25	1424	20	56	1168	1048	646
	300	48	42.75	2120		112	1219	1086	962
	600	50	41.25	2819		224	1270	1105	1280
	150	48	44.59	1990		56	1219	1133	903

Dimensions and Weights in English Units					Dimensions and Weights in Metric Units				
Diameter (inches)	Flange Weight (lb)	A (in)	C (in)	Weight (lb)	Diameter (inches)	Flange Weight (kg)	A (mm)	C (mm)	Weight (kg)
24	300	50	46.59	2947	24	112	1270	1183	1337
	600	52	47.09	3946		224	1321	1196	1790

#### 1.3.2.4 Flange Ratings

- 150 #
- 300 #

Others on request.

#### 1.3.2.5 Pipe Schedules

- 10S
- 40S
- STD

Others on request.

#### 1.3.2.6 PED Compliance

- ASME B31.3
- PED Cat III, Module H

#### 1.3.2.7 Installation Requirement

The meter must be installed with 20D straight piping upstream and 10D straight piping downstream. Inlet and outlet piping shall match the meter ID. Pressure, temperature and density connections must be located in the downstream piping. The 20D upstream piping must be free of items that could disturb the flow profile.

### 1.3.3 Electronics

#### 1.3.3.1 Electronics Enclosure Material

Epoxy-coated aluminum

#### 1.3.3.2 Weight

25 lb (11.5 kg)

#### 1.3.3.3 Dimensions

Size (l x h x d): 13" x 11" x 9" (33 x 27 x 23 cm)

#### 1.3.3.4 Ingress Protection

- USA / Canada: Type 4
- Europe: IP66

#### 1.3.3.5 Power Supply

- 100 - 240 VAC
- 12 - 32 VDC

#### 1.3.3.6 Power Consumption

< 20 Watts

#### 1.3.3.7 Display

High contrast 128 x 64 pixel graphical display with LED illumination.

#### 1.3.3.8 Outputs

- Two frequency/pulse isolated outputs

- Two alarm relays
- One 4/20 mA isolated output with HART

### 1.3.3.9 Inputs

Two 4/20 mA and one 100 Ohm RTD input for density, pressure and temperature input (optional), or Three 4/20 mA inputs for density, pressure and temperature input (optional).

### 1.3.3.10 Digital Interfaces

- HART over 4/20 mA output
- Panalink over RS232/485/USB
- Modbus over RS232/485 (optional)

### 1.3.3.11 Flow Computer Functionality

Integrated flow computer with full P and T volume corrections according to API 11.1

### 1.3.3.12 Hazardous Area Classification

- USA / Canada:  
Class I, Division 1, Groups B, C and D; T6  
Class II and III, Division 1, Groups E, F & G; T6  
Ta = -40°C to +60°C  
Enclosure Type 4X & IP66
- Europe:  
ATEX and IECEx:  
II 2 G Ex d IIB + H2, T6 IP66  
II 2 D Ex tD A21 IP66 T85C  
Ta = -40° to +60°C

### 1.3.3.13 CE Marking Compliance

- 2006/95/EC Low Voltage Directive
- 97/23/EC Pressure Equipment Directive

## 1.3.4 Ordering Information

### 1.3.4.1 Sentinel Electronics SEN898

Table 5 below shows how the Sentinel LNG Electronics SEN898 part numbers are configured from the options specified.

A            - B   - C   - D   - E   - F   - G   - Z  
SEN898   - |   -   -   -   -   -   -

LTR	CATEGORY	OPTIONS
B	Power	<b>1</b> = 100 to 240 VAC operating voltage <b>2</b> = 12 to 32 VDC operating voltage
C	Inputs	<b>1</b> = One 100 Ohm RTD input; Two 4-20mA inputs <b>2</b> = Three 4-20mA inputs
D	Communications	<b>0</b> = Std W/2 frequency/pulse outputs, one 4-20mA output w/HART, two alarms and Panalink over RS232/RS485/USB <b>1</b> = Modbus RTU over RS232/RS485
E	Flow Computer	<b>LNG</b> = Active compensation for tube contraction (for LNG only, 3 input board)
F	Certifications	<b>1</b> = N. American Explosion Proof, Class I, Div 1, groups B, C and D <b>2</b> = European Flame Proof, II 2G Ex d IIC <b>3</b> = European Flame Proof increased safety, II 2G Ex de IIC

LTR	CATEGORY	OPTIONS
G	Electronics Mounting	L = Local mounting on SEN-LNG Flowcell R = Remote mounting from SEN-LNG Flowcell S = Stand-alone unit w/ remote mounting; cable length selectable (max. 300 ft, 91.4 m)
Z	Special Requirements	<b>0</b> = None <b>S</b> = Special

### 1.3.4.2 Sentinel LNG Liquid Custody Transfer Flowmeter

Table 6 below shows how the Sentinel LNG Flow Section part numbers are configured from the options specified.

A            - B - C - D - E - F - G - H - I - Z  
 SEN-LNG - | - - - - - - - - -

LTR	CATEGORY	OPTIONS
B	Nominal Size*	<b>4</b> = 4" <b>10</b> = 10" <b>14</b> = 14" <b>18</b> = 18" <b>24</b> = 24" <b>6</b> = 6" <b>12</b> = 12" <b>16</b> = 16" <b>20</b> = 20" <b>36</b> = 36" <b>8</b> = 8"
C	Pressure Class	<b>150</b> = 150 lbs pressure rating <b>300</b> = 300 lbs pressure rating
D	Material	<b>304</b> = Stainless Steel, A182 Grade 304/304L <b>316</b> = Stainless Steel, A182 Grade 316/316L
E	Schedule	<b>10S</b> = Schedule size 10S <b>40S</b> = Schedule size 40S <b>STD</b> = Standard <b>S</b> = Special
F	Design Criteria	<b>A</b> = ASME B31.3 <b>P</b> = ASME B31.3 with PED
G	Electronics Mtg	<b>S</b> = Remote Mounting, cable length selectable (max 300 ft)
H	Material Certs	<b>0</b> = None <b>1</b> = Material Certs <b>2</b> = Material certs with EN 10204 3.1 inspection certificate
I	NACE Requirements	<b>0</b> = None <b>1</b> = NACE MR0175 <b>2</b> = NACE MR0103
J	Special Requirements	<b>0</b> = None <b>S</b> = Special
* SEN-LNG Flowcell w/ RF Flanges according to ASME B16.5 for sizes 4-24" SEN-LNG Flowcell w/ RF Flanges according to ASME B16.47 for size 36"		

## 1.4 Disclaimer

---

The warranties set forth herein are exclusive and are in lieu of all other warranties whether statutory, express or implied (including warranties of merchantability and fitness for a particular purpose, and warranties arising from course of dealing or usage or trade).

---

## 1.5 Warnings and Cautions

**WARNING!** The Sentinel Flow Measurement System measures the flow rate of hazardous fluids. The importance of proper safety practices cannot be overemphasized.

So be sure to follow all applicable local safety codes and regulations for installing electrical equipment and working with hazardous gases or flow conditions. Consult company safety personnel or local safety authorities to verify the safety of any procedure or practice.

**WARNING!**

To meet CE Mark requirements, all cables must be installed as described in Appendix B, *CE Mark Compliance*.

**WARNING!**

Always disconnect the line power from the meter before removing either the front cover or the side cover. This is especially important in a hazardous environment.

**WARNING!**

Improper connection of the line power leads or connecting a Sentinel to the incorrect line voltage may damage the unit. It may also result in hazardous voltages at the meter body and associated piping as well as within the electronics enclosure.

**WARNING!**

Make sure the front and side covers, along with their O-ring seals, are installed on the transmitter, and the set screws tightened before applying power in a hazardous environment.

**WARNING!**

Never remove the flowmeter covers in a hazardous environment while the line power is on.



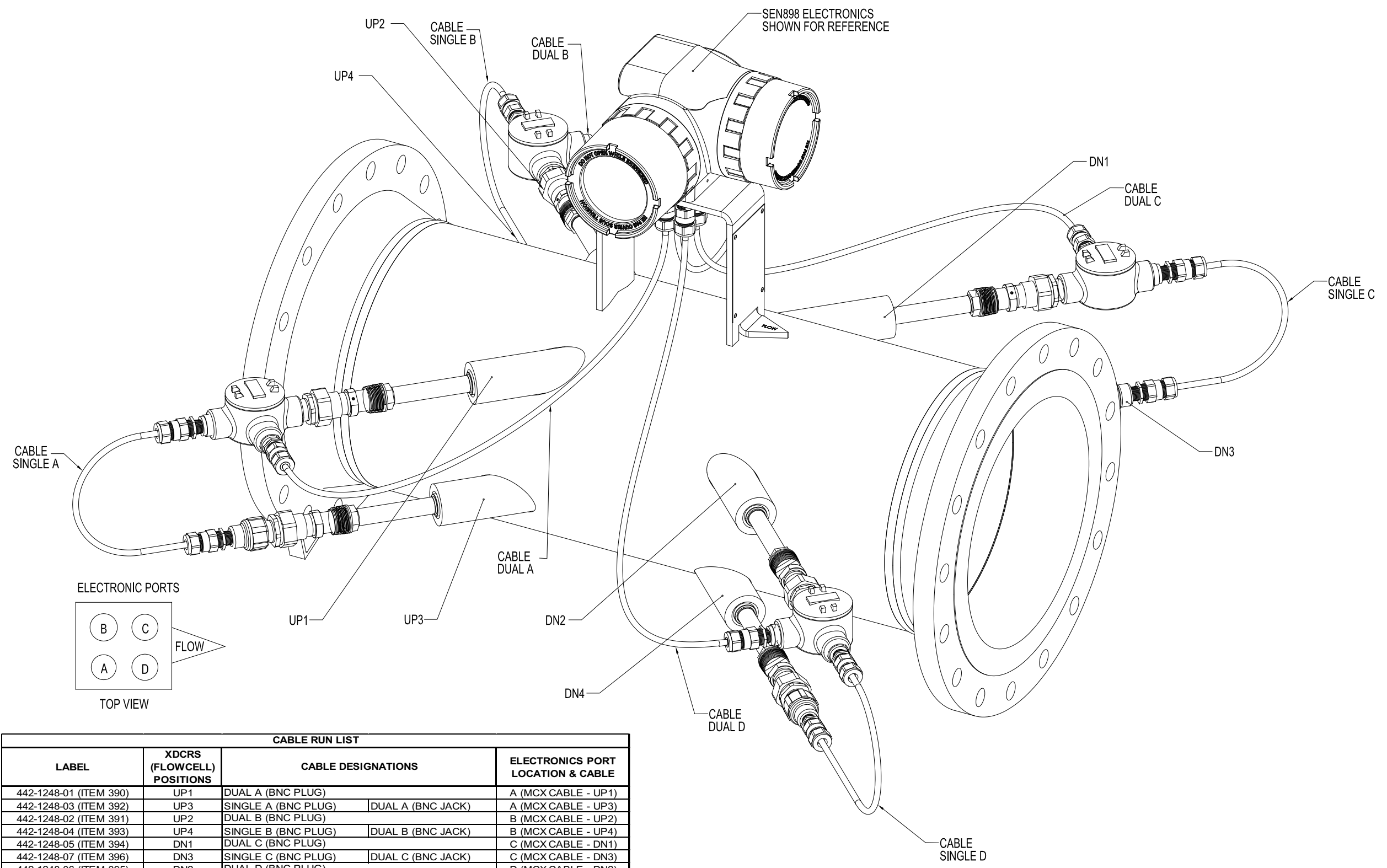

CABLE RUN LIST				
LABEL	XDCRS (FLOWCELL) POSITIONS	CABLE DESIGNATIONS		ELECTRONICS PORT LOCATION & CABLE
442-1248-01 (ITEM 390)	UP1	DUAL A (BNC PLUG)		A (MCX CABLE - UP1)
442-1248-03 (ITEM 392)	UP3	SINGLE A (BNC PLUG)	DUAL A (BNC JACK)	A (MCX CABLE - UP3)
442-1248-02 (ITEM 391)	UP2	DUAL B (BNC PLUG)		B (MCX CABLE - UP2)
442-1248-04 (ITEM 393)	UP4	SINGLE B (BNC PLUG)	DUAL B (BNC JACK)	B (MCX CABLE - UP4)
442-1248-05 (ITEM 394)	DN1	DUAL C (BNC PLUG)		C (MCX CABLE - DN1)
442-1248-07 (ITEM 396)	DN3	SINGLE C (BNC PLUG)	DUAL C (BNC JACK)	C (MCX CABLE - DN3)
442-1248-06 (ITEM 395)	DN2	DUAL D (BNC PLUG)		D (MCX CABLE - DN2)
442-1248-08 (ITEM 397)	DN4	SINGLE D (BNC PLUG)	DUAL D (BNC JACK)	D (MCX CABLE - DN4)

Figure 4: Sentinel LNG Assembly for Pipes 4-36" in Diameter (ref. dwg #577-071)



## Chapter 2. Installation

### 2.1 Installation Guidelines

This section provides general information with respect to the mechanical and electrical installation, and should be thoroughly reviewed before the system is installed. To ensure safe and reliable operation of the Sentinel LNG, the system must be installed in accordance with the guidelines established by Panametrics Sensing, as explained in this chapter.

**WARNING!** The Sentinel LNG Ultrasonic Liquid Flow Transmitter measures the flow rate of hazardous fluids. The importance of proper safety practices cannot be overemphasized.

**So be sure to follow all applicable local safety codes and regulations for installing electrical equipment and working with hazardous liquids or flow conditions. Consult company safety personnel or local safety authorities to verify the safety of any procedure or practice.**

**WARNING!**

**To meet CE Mark requirements, all cables must be installed as described in Appendix B, *CE Mark Compliance*.**

### 2.2 Bill of Materials

The following items should have been included in the shipment:

- Sentinel LNG flowmeter body
- Sentinel SEN898 electronics
- Magnetic Stylus
- User's Manual on CD
- CD with PanaView Software

## 2.3 Mechanical Installation

### 2.3.1 Location

For both uni-directional and bi-directional flow (see Figure 5 and Figure 6 below), a minimum of five diameters of straight pipe shall be provided by the customer on either side of the meter run, directly upstream of the flow conditioning plate and downstream of any disturbances or pipe bends. An additional length of straight pipe will help produce a more symmetrical flow profile, thus reducing the measurement uncertainty.

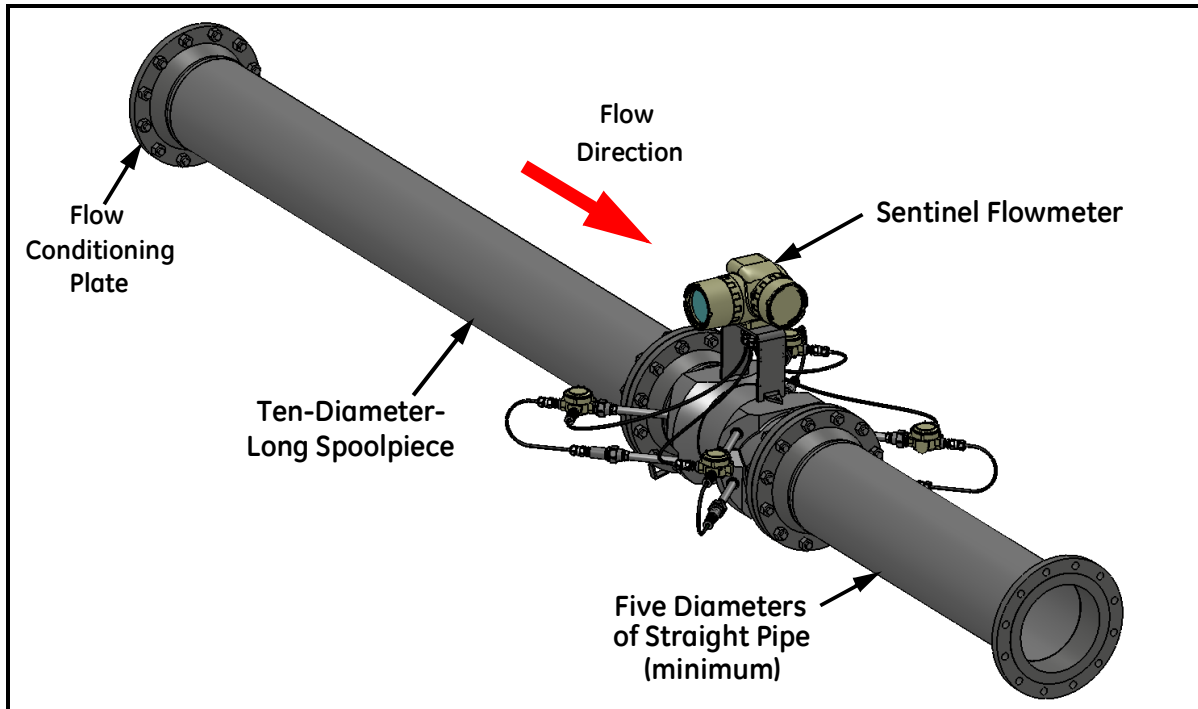

Figure 5: Typical Sentinel LNG Installation, Uni-Directional Flow

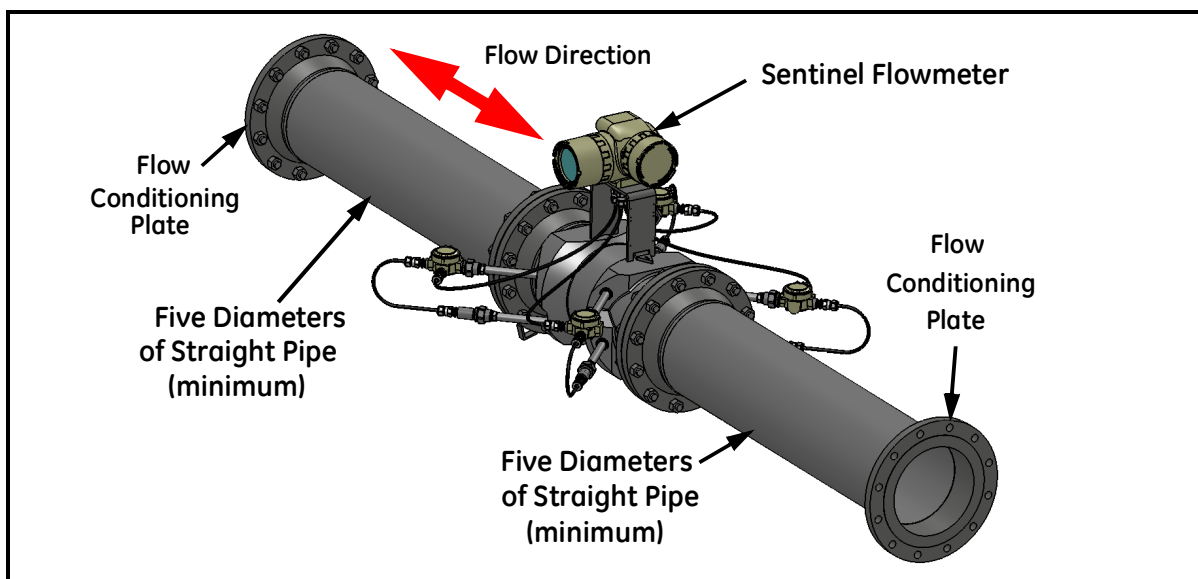

Figure 6: Typical Sentinel LNG Installation, Bi-Directional Flow

### 2.3.2 Installation Precautions

Any questions with respect to the installation should be addressed prior to beginning the installation. Failure to install the Sentinel LNG correctly can increase measurement uncertainty.

**CAUTION!** To avoid possible strain, refer to the Sentinel LNG label for the assembly weight, use a properly-rated lifting assembly, and place the lifting straps in the indicated locations (see Figure 7 below).

All the mechanical and electronic components are shipped fully assembled (see Figure 4 on page 13), however the following precautions should be observed:

- Make sure the difference between the inside diameter of the pipe and that of the Sentinel LNG spoolpiece does not exceed 1%. (Changes in internal diameters will cause flow profile disturbances.)
- Make sure any non-symmetrical offset does not exceed 1%. (Misalignment between the piping and the spoolpiece may cause flow profile disturbances.)
- Make sure the gasket is centered on the flange faces and does not protrude into the pipe. (Protrusion of the gasket into the pipe may cause flow profile disturbances.)
- Make sure the Sentinel LNG is oriented with the flow transmitter in a vertical position at the top (see Figure 7 below).

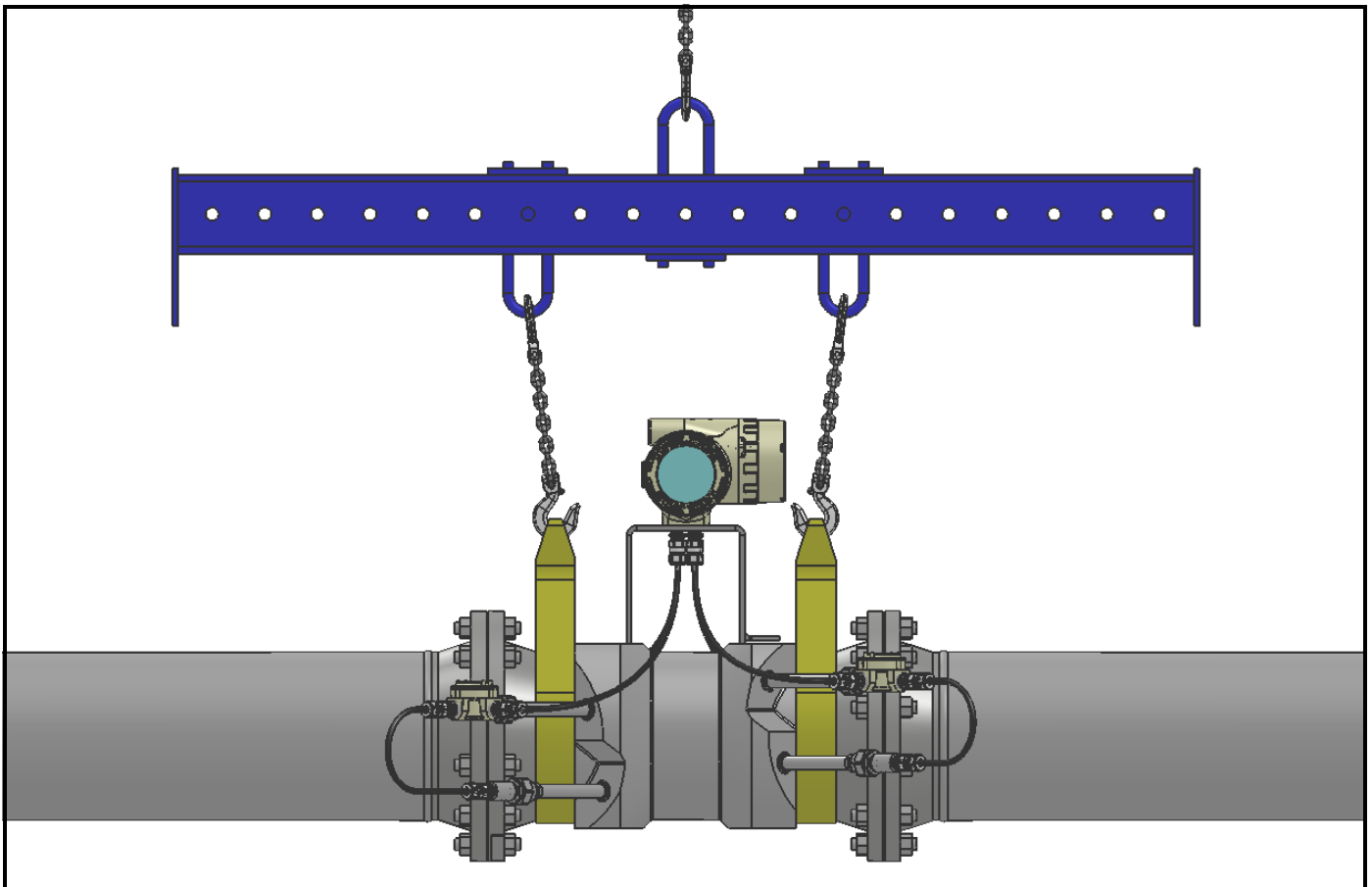

Figure 7: Lifting Strap Locations

### 2.3.3 Installing the System

Being mindful of *Installation Precautions* listed on page 17, complete the following steps:

1. Make sure the gaskets are in place on the flanges.
2. Support the Sentinel LNG between the flanges on the pipe.
3. Align the flange mounting holes (see Figure 8 below).

4. Secure the spoolpiece to the pipe by using the appropriate hardware.

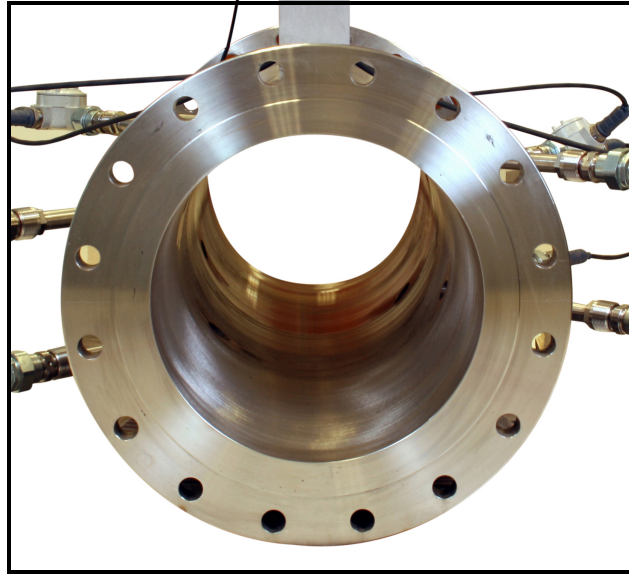

Figure 8: Sentinel End View - Mounting Flange

### 2.3.4 Guidelines for Installing Pipe Insulation

If pipe insulation is required:

1. Install all insulation materials and accessories in accordance with the manufacturer's instructions and the recognized industry practices. Adhere to the local code where applicable to ensure that the safe and proper installation will serve its intended purpose.
2. Install the insulation material in layers, with smooth and even surfaces. Allow adequate space (air pockets) around all extended transducer buffer rods, conduit fittings, junction boxes, and cables, for proper ventilation. Avoid using cut pieces or scrap insulation when abutting the sections being installed. Butt insulation joints firmly to ensure a complete, tight fit over and around all piping surfaces.
3. Maintain the integrity of any factory-applied vapor barrier jacketing on all pipe insulation, if applicable. Seal all joints and seams, protecting the insulation against puncture, tears or other damage.

## 2.4 Making Electrical Connections

This section contains instructions for making the necessary electrical connections to the flow transmitter (see Figure 9 below). The wiring between transmitter and transducers has been accomplished at the factory. No further work is required on this portion of the wiring.

**IMPORTANT:** When wires are connected to terminal blocks, use wire ties routed through the blocks, to secure them.

**WARNING!**

To meet CE Mark requirements, all cables must be installed as described in Appendix B, *CE Mark Compliance*.

**IMPORTANT:** The meter spoolpiece is grounded to the electronics. This configuration must be considered when applying cathodic protection to the pipe line. The power ground applied to the instrument should be at the cathodic protection voltage level.

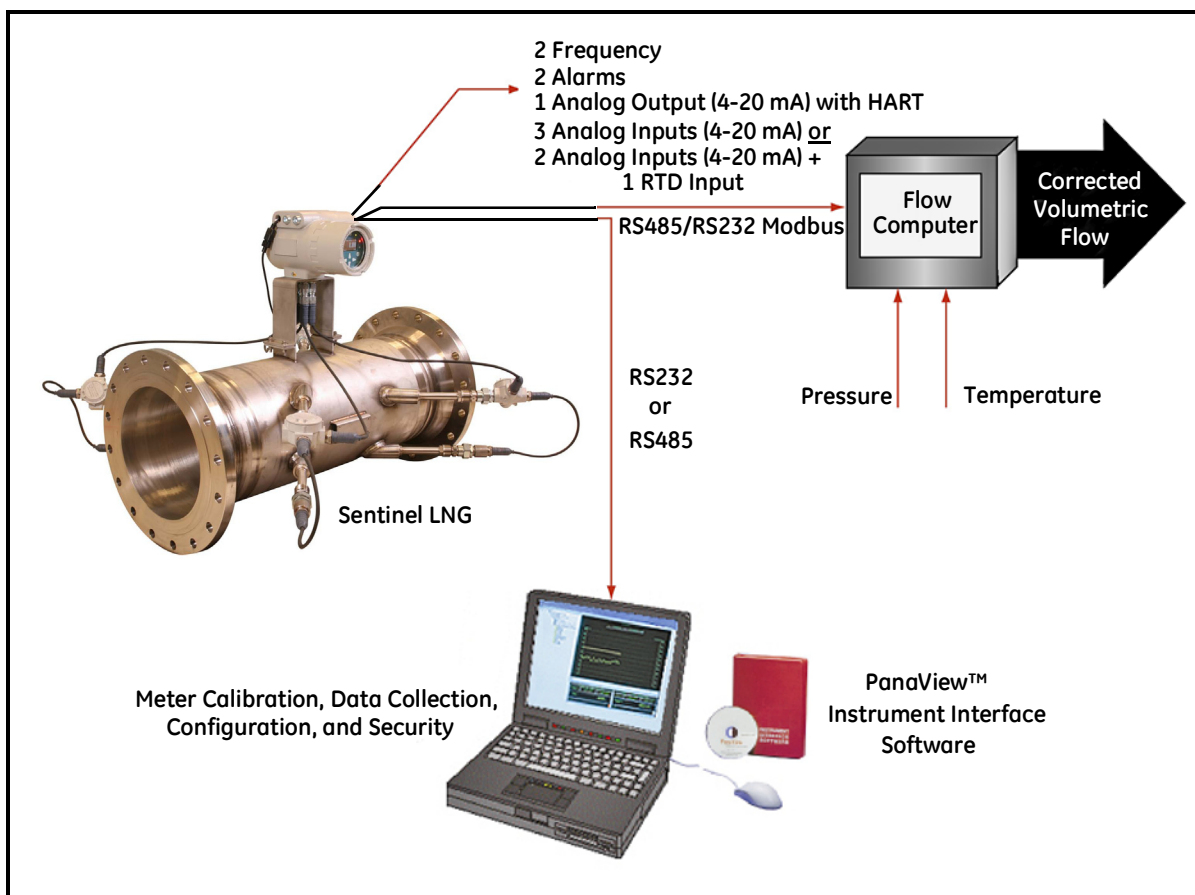

Figure 9: Sentinel LNG Flow Measurement System Connections

## 2.4.1 Removing the Covers

**WARNING!** Always disconnect the line power from the meters before removing either the front cover or the side cover. This is especially important in a hazardous environment.

1. Disconnect any previously wired power line from the flow transmitter.
2. Loosen the set screw on the side cover using a 2.5 mm hex wrench.
3. Place a rod or long screwdriver across the cover in the slots provided, and rotate the cover counterclockwise until it comes free from the enclosure.
4. Note the text imprinted on the terminal board (see Figure 10 below) to assist in wiring the power and option card connections.

Proceed to the appropriate section of this chapter to make the desired wiring connections.

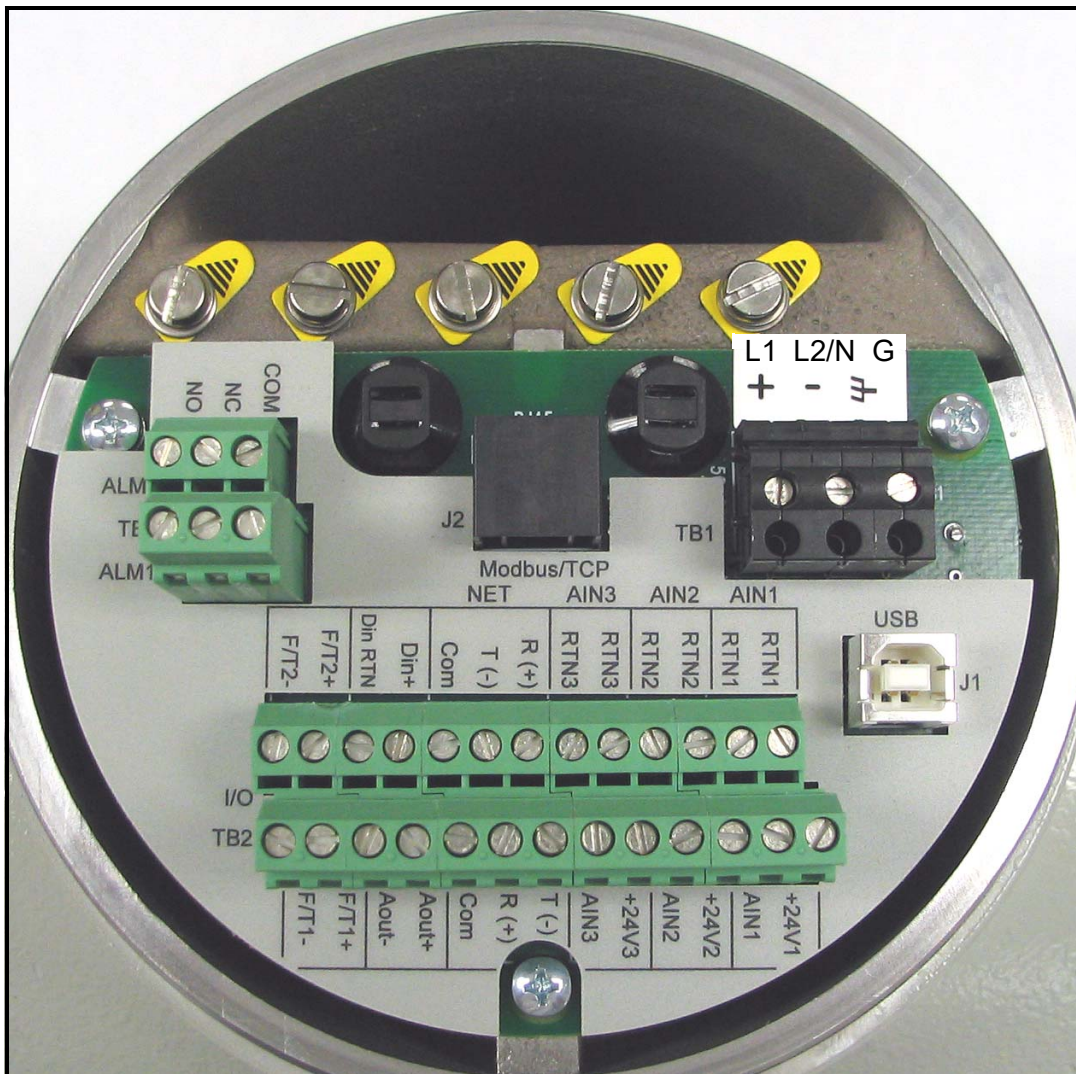

Figure 10: Terminal Board with Imprinted Text (Three 4-20mA Input Options)

## 2.4.2 Cable Tie-Down Posts

There are two cable tie-down posts provided in the Sentinel LNG (see Figure 11 below). These posts enable the user to insert a cable tie through them, and secure wiring coming into or out of the instrument. The posts rotate on the printed circuit board to provide ease-of-use.

- **Power Cable Tie-Down Post** - Use this tie-down post to secure the instrument power securely.



- Optional I/O Cable Tie-Down Post - Use this optional tie-down post to secure any other instrument I/O securely.

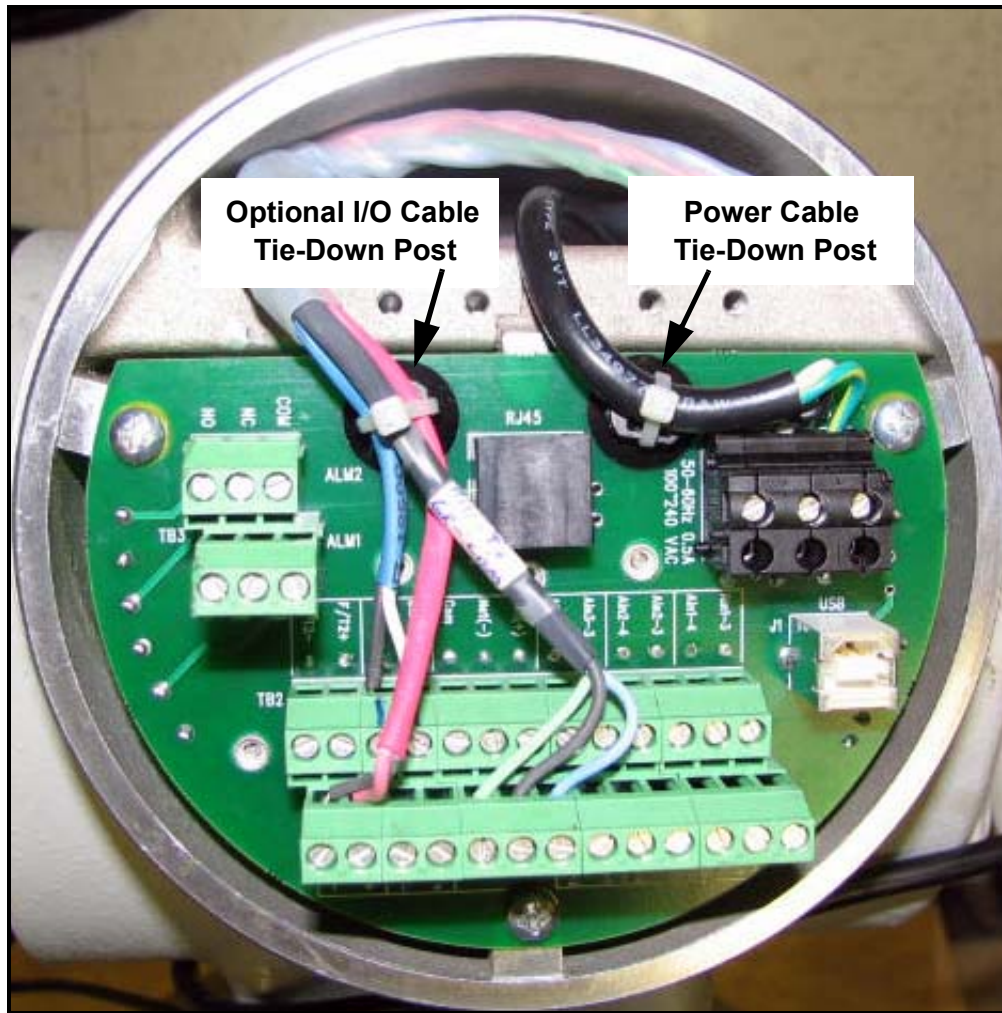

Figure 11: Cable Tie-Down Posts Locations

### 2.4.3 Wiring the Line Power

The Sentinel LNG may be ordered for operation with a power input of 100–240 VAC or 12–32 VDC (see the *Electronics Ordering Information* in Table 5 on page 10). The label on the side of the electronics enclosure lists the required line voltage and power rating. The fuse size is listed in *Specifications* in Chapter 1. Be sure to connect the Sentinel LNG to the specified line voltage only.

**Note:** For compliance with N. American and European Low Voltage Directive (2006/95/EC), this unit requires an external power disconnect device such as a switch or circuit breaker. The disconnect device must be marked as such, clearly visible, directly accessible, and located within 1.8 m (6 ft) of the unit.

**Note:** Use one conduit inlet for power. Use the two other conduit inlets for input/output as needed. All unused conduit inlet ports should be sealed with suitable blanking elements.

See Figure 13 on page 23 to locate terminal block TBI and to connect the line power as outlined below:

**WARNING!** Improper connection of the line power leads or connecting a Sentinel to the incorrect line voltage may damage the unit. It may also result in hazardous voltages at the meter body and associated piping as well as within the electronics enclosure.

1. Prepare the line power leads by trimming the line and neutral AC power leads (or the positive and negative DC power leads) to a length 0.5 in. (1 cm) shorter than the ground lead. This ensures that the ground lead is the last to detach if the power cable is forcibly disconnected from the meter.

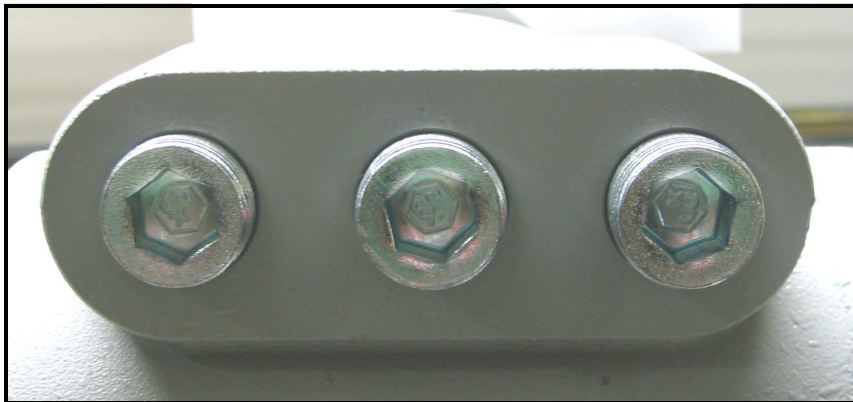

Figure 12: Conduit Inlet Ports

2. Route the cable through one of three conduit inlet ports (see Figure 12 above) and connect the line power leads to the terminal block TBI, using the pin number assignments shown in Figure 27 on page 34 and Figure 13 or Figure 14 on page 23.

**WARNING!**

To meet CE Mark requirements, all cables must be installed as described in Appendix B, *CE Mark Compliance*.

### 2.4.3 Wiring the Line Power (cont.)

**Note:** All wires shall have a temperature/type rating 10K above the maximum service temperature of 85°C, be stripped back 5/16 in. (8 mm) and torqued to a minimum of 4.4 in. lb. (0.5 Nm).

3. Run the AC power connections to the Power Terminal Block shown in Figure 13 below. It is recommended to use 12-18 AWG (3.3 - 0.82 mm<sup>2</sup>) power wiring.
4. Strip 1/4-in. of insulation from the end of each of the three line power leads.
5. Route the cable through one of three conduit inlet ports (see Figure 12 above) and connect the line power leads to terminal block TB1, using the pin assignments shown in Figure 27 on page 34 and Figure 13 or Figure 14 below.
6. Leaving a bit of slack, secure the power line with the cable clamp.

**WARNING!** Make sure the front and side covers, along with their O-ring seals, are installed on the transmitter, and the set screws tightened before applying power in a hazardous environment.

7. Once the line power has been connected to the flow transmitter, replace the side cover, tighten the set screw using a 2.5 mm hex wrench, and proceed to the next section.

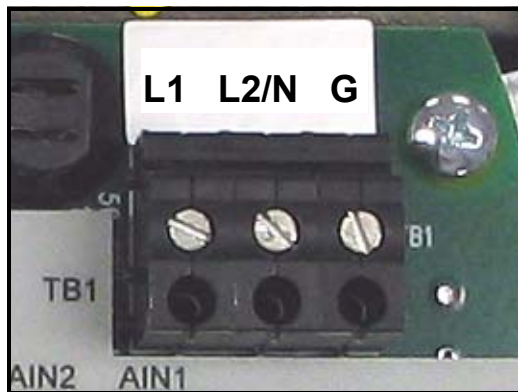

Figure 13: Wiring the AC Line Power

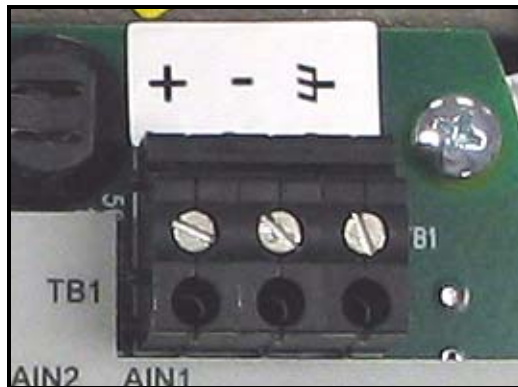

Figure 14: Wiring the DC Line Power

## 2.4.4 Wiring the Serial Port

The flow transmitter is equipped with a built-in serial communications port. The port is user-selectable to be either an RS232 or RS485 port. For more information on serial communications refer to the *EIA-RS Serial Communications Manual* (916-054). It is recommended to use 12-24 AWG (3.3 - 0.2 mm<sup>2</sup>) twisted pair wiring for single conductors, and a minimum 18 AWG (1.5 mm<sup>2</sup>) for two conductors per terminal.

### 2.4.4.1 Wiring the Serial Interface

To wire the serial port, refer to Figure 27 on page 34 and Figure 28 on page 35 and complete the following steps:

1. Disconnect the main power to the meter and remove the wiring access cover.
2. Install the required cable gland in the chosen conduit hole of the electronics enclosure.
3. Feed one end of the cable through the cable gland, wire it to terminal block TB2, and secure.

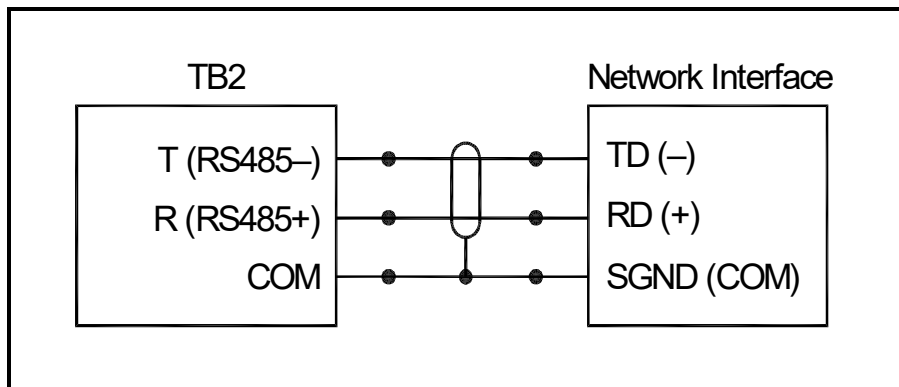

Figure 15: Serial Connections

#### **WARNING!**

To meet CE Mark requirements, all cables must be installed as described in Appendix B, *CE Mark Compliance*.

4. If the wiring of the unit has been completed, reinstall the side cover and tighten the set screw.

## 2.4.5 Wiring the Modbus Communications Line (Optional)

The Sentinel LNG uses the RS485 interface with *Modbus* communications protocol for a maximum line distance up to 4,000 ft (1,200 m). The factory recommends using shielded 18-24 AWG (0.82 - 0.2 mm<sup>2</sup>) cable having a characteristic impedance of 120 ohms, with 120-ohm termination at each end of the communications line. This interface is also user-configurable as an RS232 interface.

Connect the two leads and the shield of the *Modbus* line to the NET section of terminal block TB2 in the flowmeter. See Figure 10 on page 20 or Figure 28 on page 35.

### 2.4.6 Wiring the Alarm Relay

**Note:** The alarm relay can be wired as either Normally Open (NO) or Normally Closed (NC).

An alarm relay should be wired for *fail-safe* operation. In *fail-safe* mode, the alarm relay is constantly energized, except when it is triggered, or a power failure or other interruption occurs. See Figure 16 below for the operation of a normally open alarm relay in *fail-safe* mode.

Connect the alarm relay in accordance with the wiring instructions (see Figure 10 on page 20 and Figure 27 on page 34). For a wiring diagram see Figure 28 on page 35.

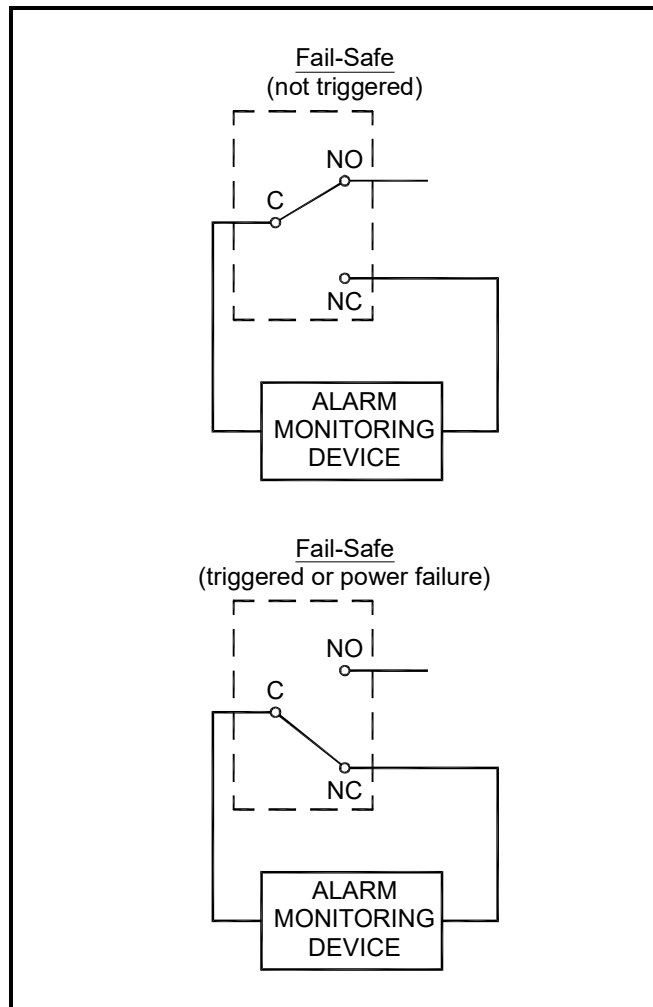

**Figure 16: Fail-Safe Operation**

It is recommended to use 12-24 AWG (3.3 - 0.2 mm<sup>2</sup>) for single conductor wiring, and 16-24 AWG (1.5 - 0.2 mm<sup>2</sup>) for two conductors per terminal.

### 2.4.7 Wiring the 4-20mA Analog Inputs (Optional)

1. Disconnect the main power to the flowmeter and remove the enclosure side cover.
2. Install a cable gland in the chosen conduit hole on the top of the electronics enclosure and feed a standard twisted-pair cable through this conduit hole.
3. Locate the 26-pin terminal block (TB2) in Figure 27 on page 34, and wire the I/O terminal as indicated on the label inside the wiring access cover (see Figure 10 on page 20, Figure 27 on page 34 or Figure 28 on page 35).
4. Secure the cable clamp.

**WARNING!**

**To meet CE Mark requirements, all cables must be installed as described in Appendix B, CE Mark Compliance.**

5. If wiring of the unit has been completed, reinstall the side cover on the enclosure and tighten the set screw.

The analog input option provides either three isolated 4-20mA analog inputs, or two isolated 4-20mA analog inputs and one RTD input (designated Ain1, Ain2, Ain3 and RTD1). Each of the 4-20 inputs includes a 24 VDC power supply for loop-powered transmitters. The inputs may be used to process temperature, density and pressure signals.

**Note:** *To enter programming data during operation of the Sentinel LNG, it will be necessary to know which input is assigned to which process parameter. This information should be entered in Appendix C, Data Records.*

The analog inputs, which have an impedance of 118 ohms, should be connected with standard twisted-pair wiring. Power to the transmitter may be supplied either by the internal 24 VDC power supply on the analog input terminal or by an external power supply. Figure 17 on page 27 shows typical wiring diagrams, with and without an external power supply, for one of the analog inputs. Figure 18 on page 27 shows 4-wire RTD input wiring. Wire the analog inputs as shown on the label in the enclosure side cover (see Figure 10 on page 20 and Figure 26 on page 33). Terminal locations are shown in Figure 19 on page 28 through Figure 22 on page 29.

It is recommended to use 12-24 AWG (3.3 - 0.2 mm<sup>2</sup>) for single conductor wiring, and 16-24 AWG (1.5 - 0.2 mm<sup>2</sup>) for two conductors per terminal.

### 2.4.7 Wiring the 4-20mA Analog Inputs (cont.)

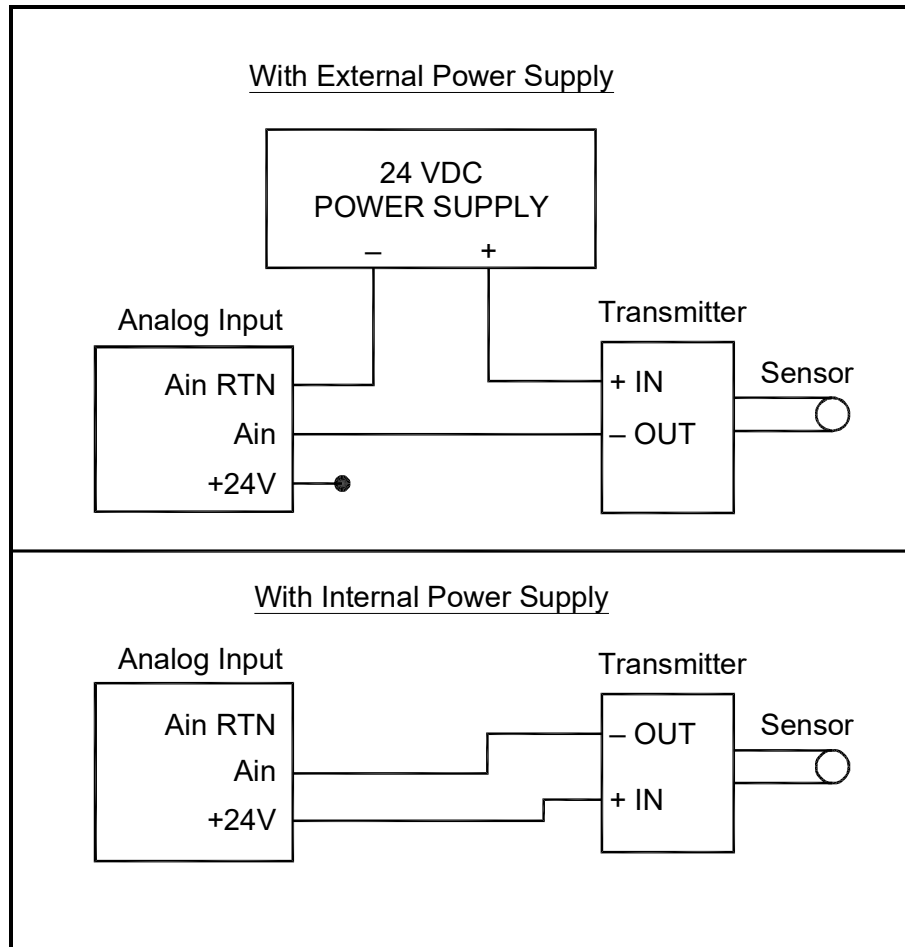

Figure 17: Analog Input Wiring Diagram

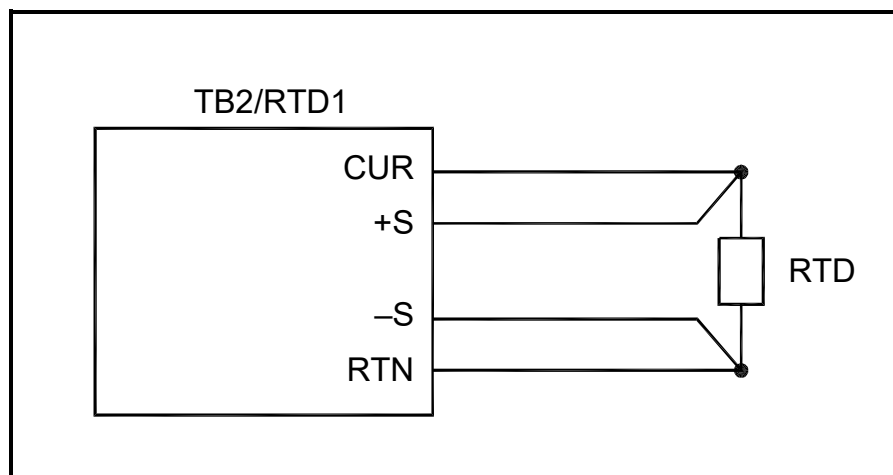

Figure 18: 4-Wire RTD Input Wiring Diagram

### 2.4.7 Wiring the 0/4-20 mA Analog Inputs (cont.)

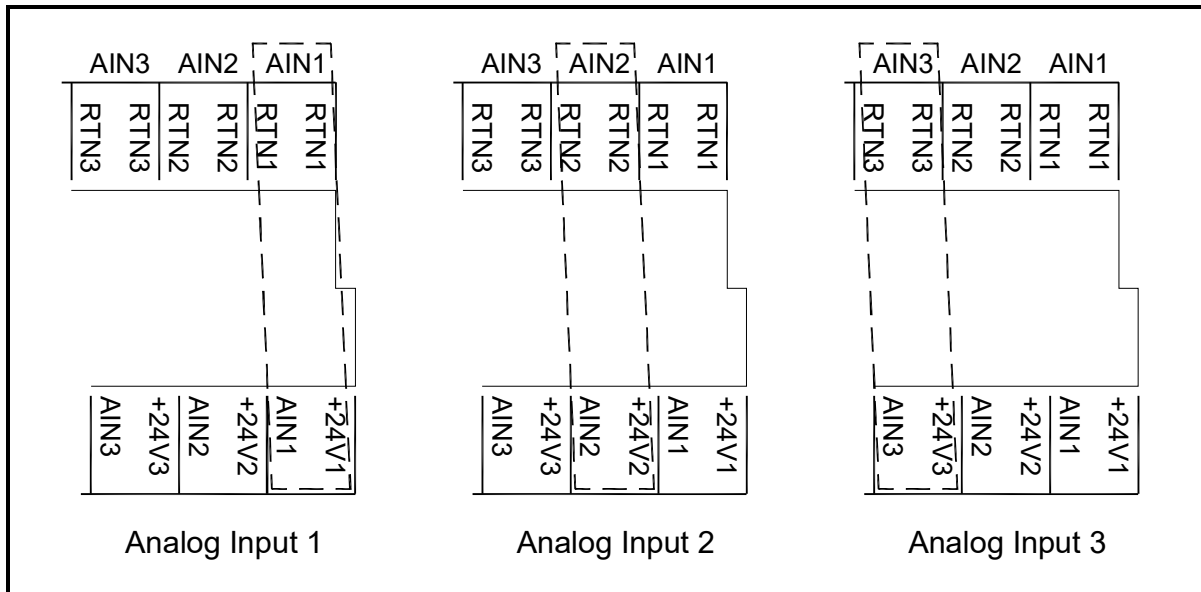

Figure 19: Terminal Locations for 3 Analog Input Option

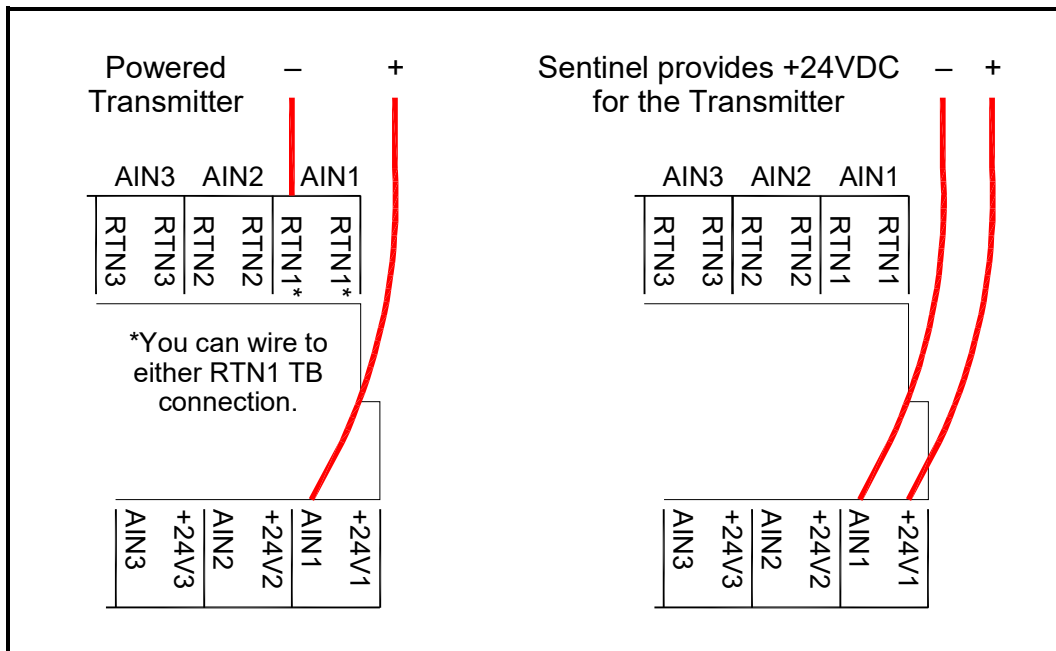

Figure 20: Terminal Locations for Analog Transmitter Use Cases



2.4.7 Wiring the 0/4-20 mA Analog Inputs (cont.)

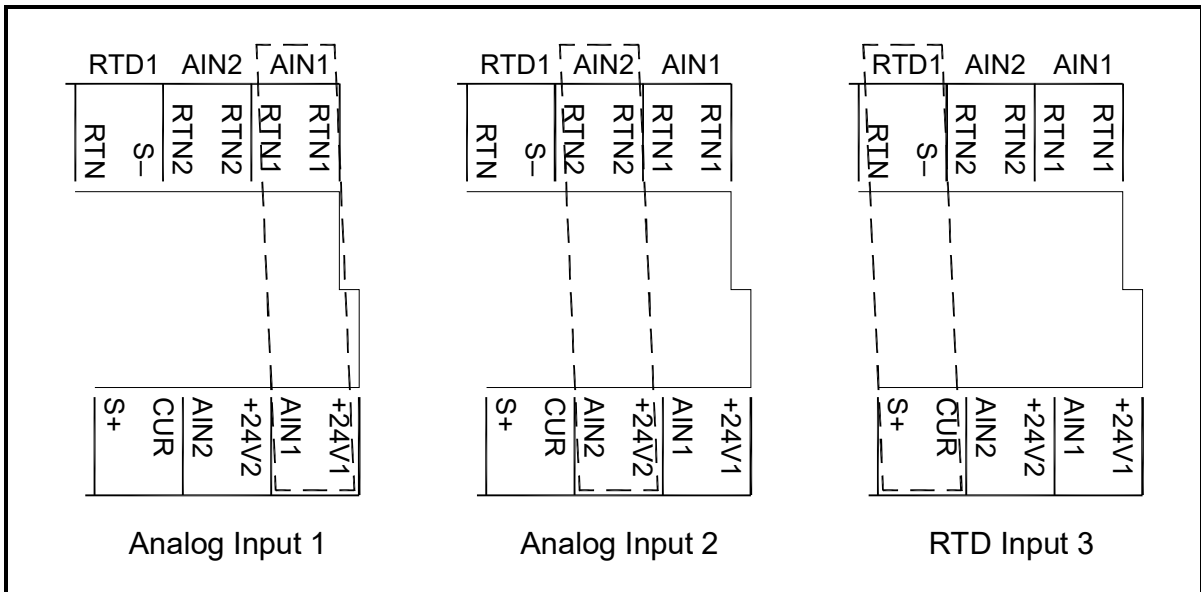

Figure 21: Terminal Locations for 2 Analog Input and 1 RTD Input Option

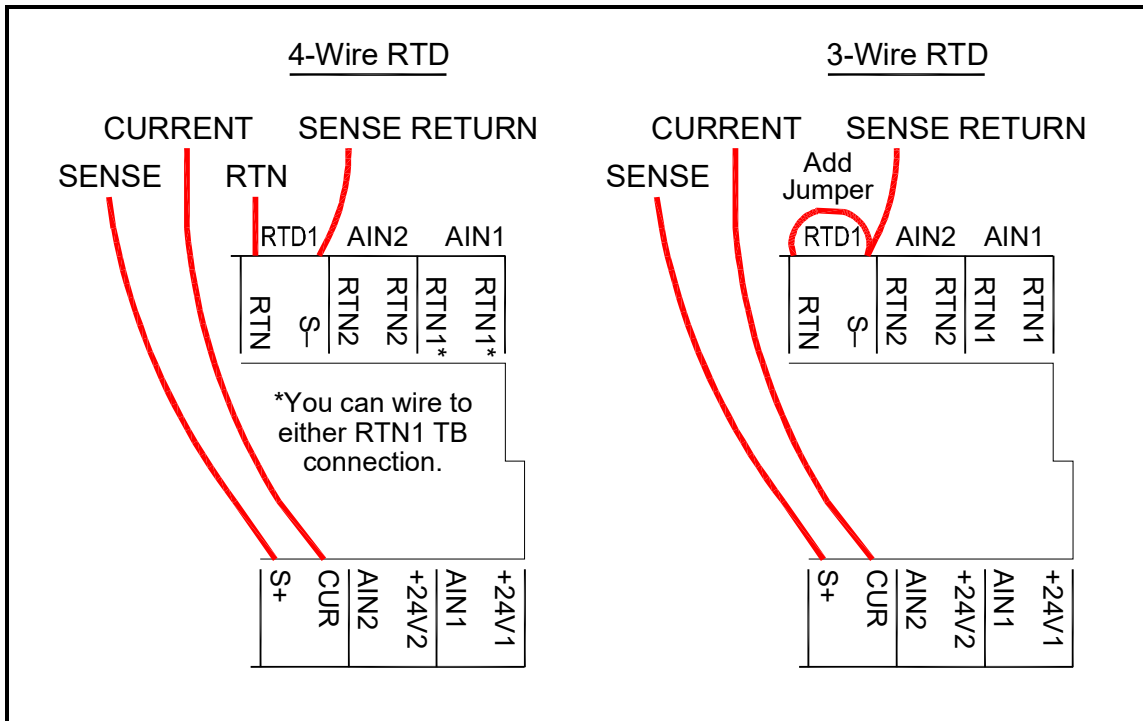

Figure 22: Terminal Locations for 4-Wire and 3-Wire RTD Use Cases

## 2.4.8 Wiring the Frequency Output

Figure 23 below shows sample wiring diagrams of the frequency/totalizer output circuit for open drain and push-pull configurations. It is recommended to use 12-24 AWG (3.3 - 0.2 mm<sup>2</sup>) for single conductor wiring, and 16-24 AWG (1.5 - 0.2 mm<sup>2</sup>) for two conductors per terminal.

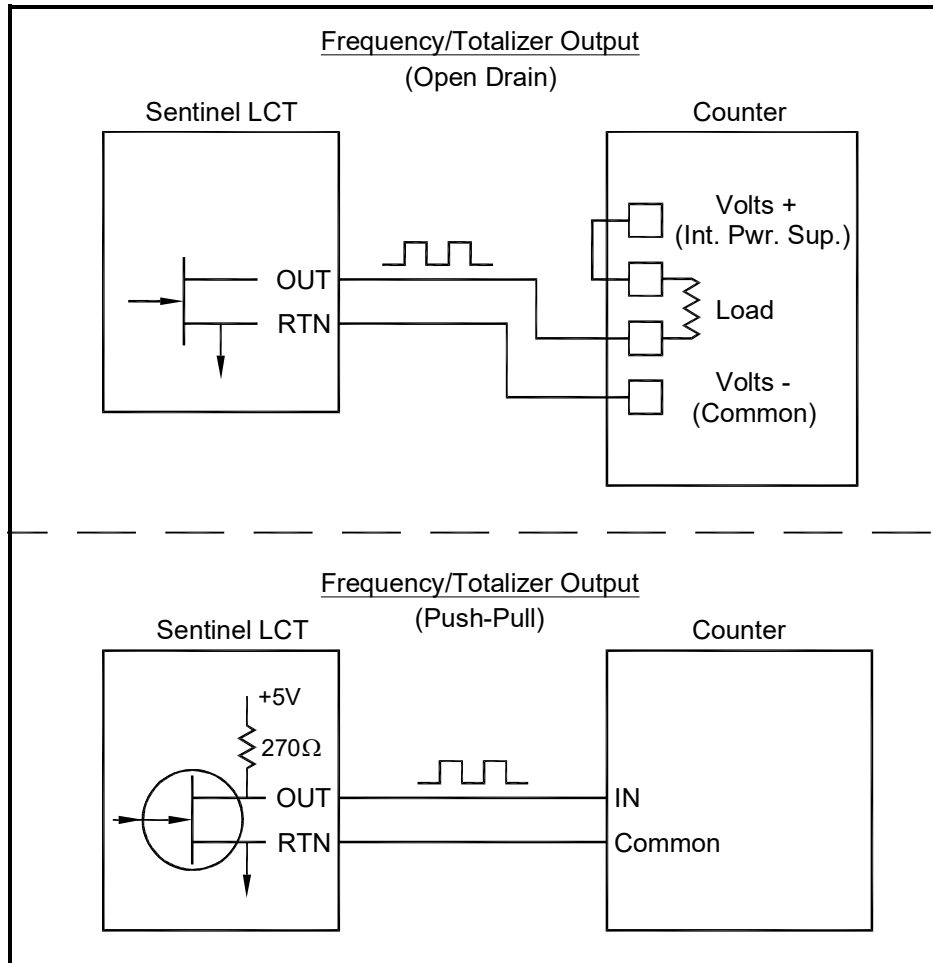

Figure 23: Totalizer and Frequency Output Wiring

F/T1+	Freq 1/Totalizer 1 OUT
F/T1-	Freq 1/Totalizer 1 RTN
F/T2+	Freq 2/Totalizer 2 OUT
F/T2-	Freq 2/Totalizer 2 RTN
NET R (+)	MODBUS-RTU RS232 (R)/RS485 (+)
NET T (-)	MODBUS-RTU RS232 (T)/RS485 (-)
NET COM	MODBUS-RTU Common

### 2.4.9 Wiring the 4-20 mA Analog Output

The standard configuration of the flow transmitter includes an isolated 4-20 mA analog output. Connections to this output may be made with standard 12-24 AWG (3.3 - 0.2 mm<sup>2</sup>) twisted-pair wiring for single conductor, and 16-24 AWG (1.5 - 0.2 mm<sup>2</sup>) for two conductors, but the current loop impedance for these circuits must not exceed 1000 ohms. To wire the analog outputs, complete the following steps:

1. Disconnect the main power to the flowmeter and remove the enclosure side cover.
2. Install the required cable clamp in the chosen conduit hole on the side of the electronics enclosure.
3. Locate the 26-pin terminal block (TB2) shown in Figure 28 on page 35, and wire the I/O terminal as indicated on the label inside the wiring access cover (see Figure 10 on page 20 and Figure 28 on page 35). For a wiring diagram see Figure 24 or Figure 25 below.

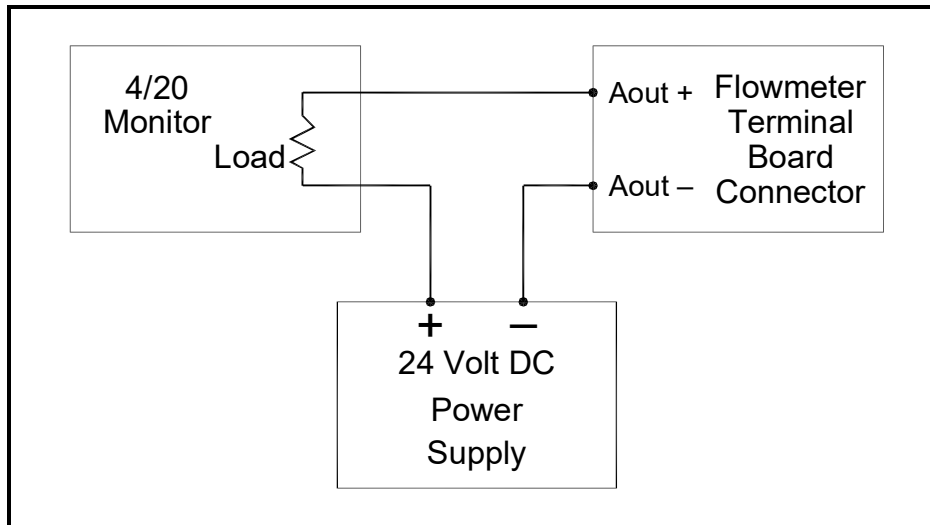

Figure 24: Analog Output Passive Wiring

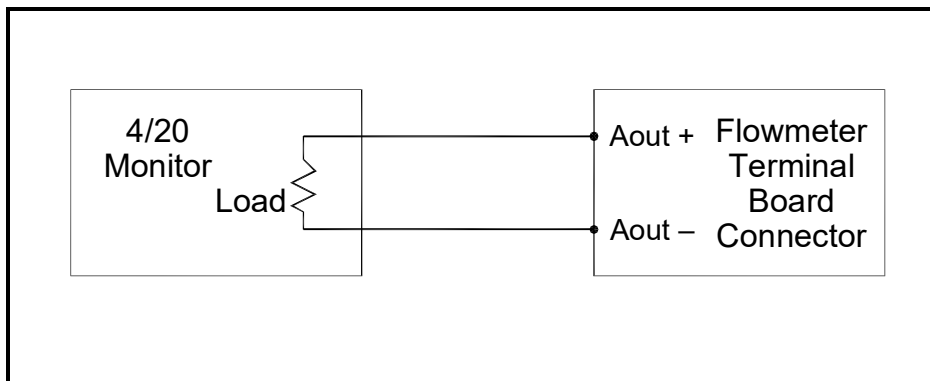

Figure 25: Analog Output Active Wiring

### 2.4.9 Wiring the 4-20 mA Analog Output (cont.)

4. Secure the cable clamp.

**WARNING!**

To meet CE Mark requirements, all cables must be installed as described in Appendix B, *CE Mark Compliance*.

5. If wiring of the unit has been completed, reinstall the wiring access cover on the enclosure and tighten the set screw.

After the Sentinel LNG has been completely installed and wired, proceed to Chapter 3, *Operation*, to program the flowmeter.

**WARNING!**

Make sure both covers, with their o-ring seals, are installed, and the set screws tightened, before applying power in a hazardous environment.

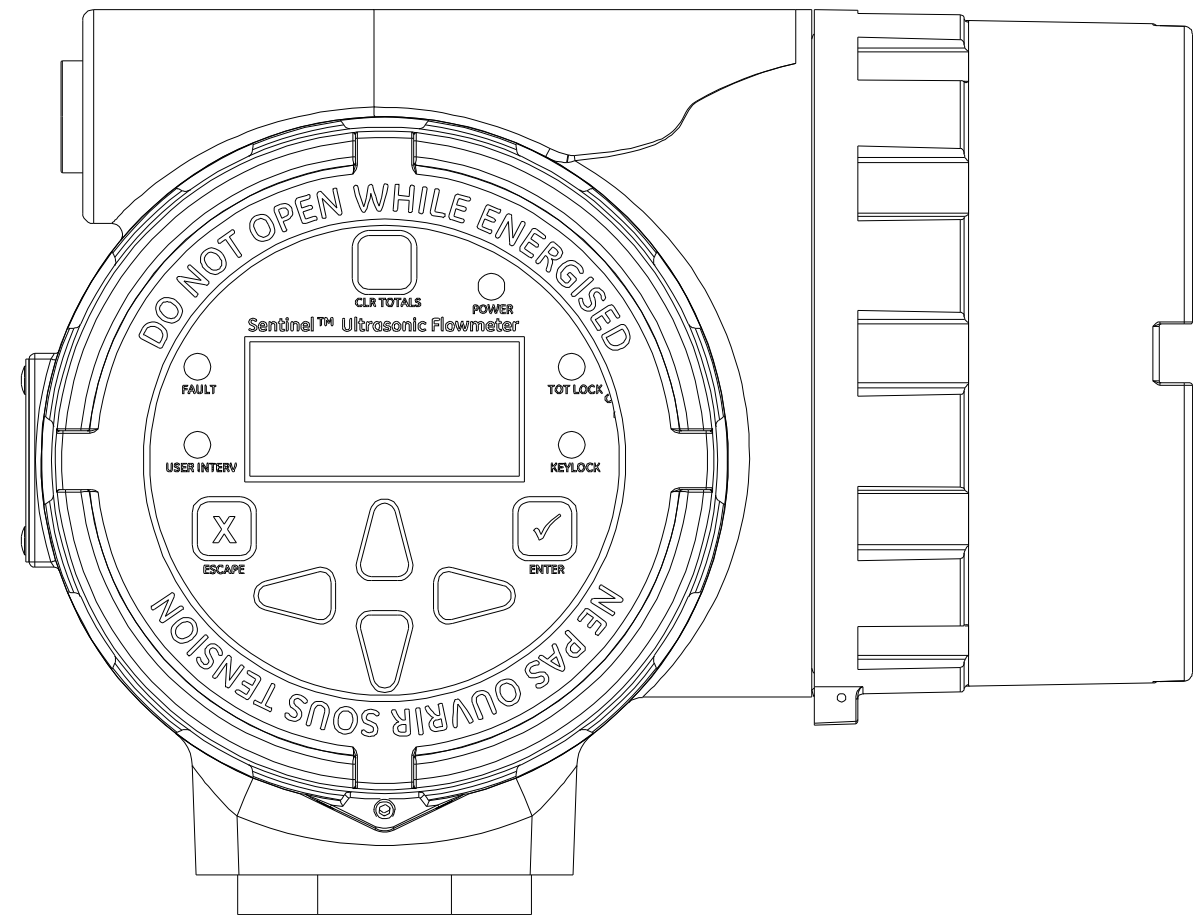

Front Display

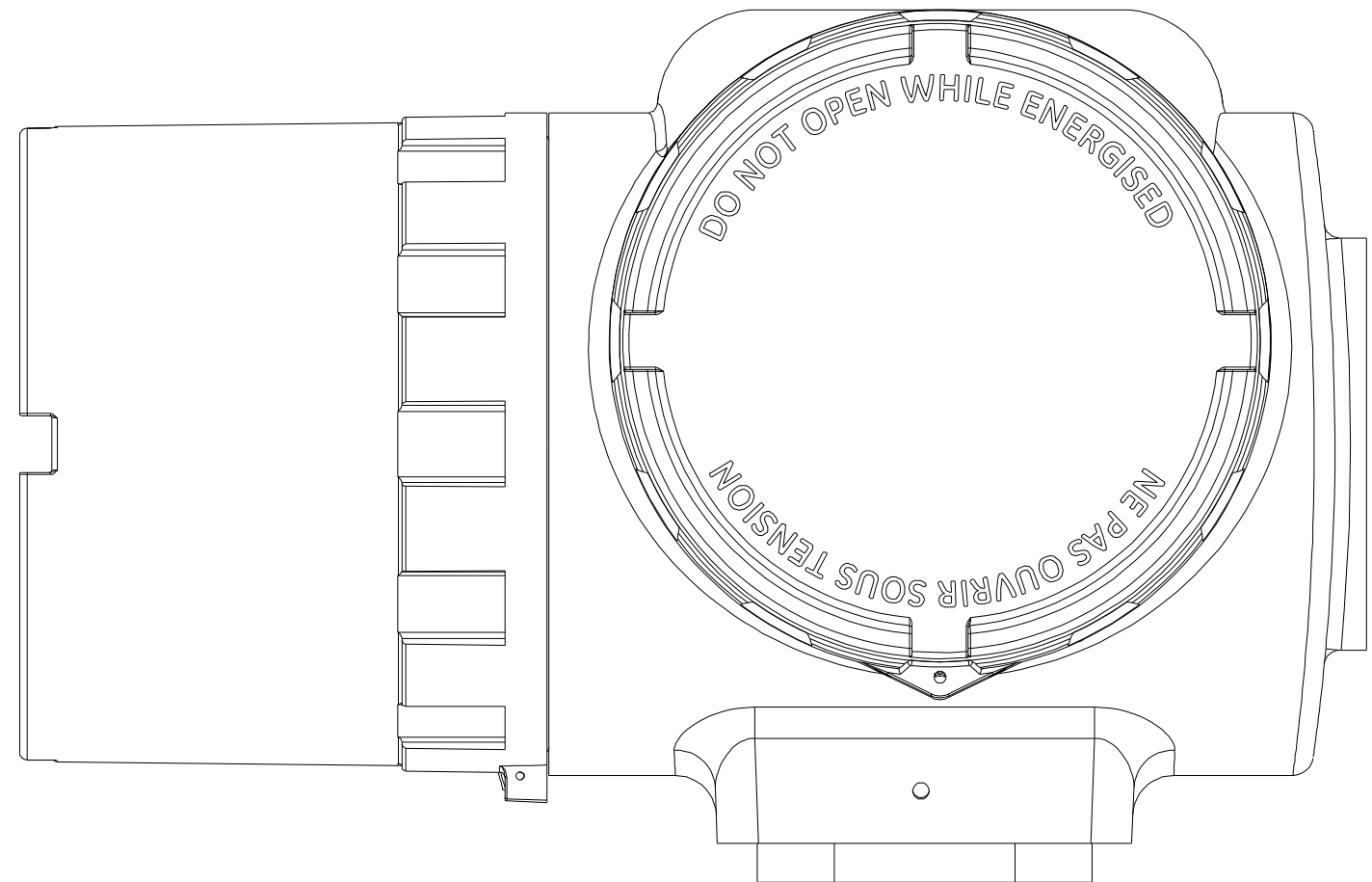

Wiring Access Cover

Figure 26: Sentinel LNG Enclosure - Front Display and Wiring Access

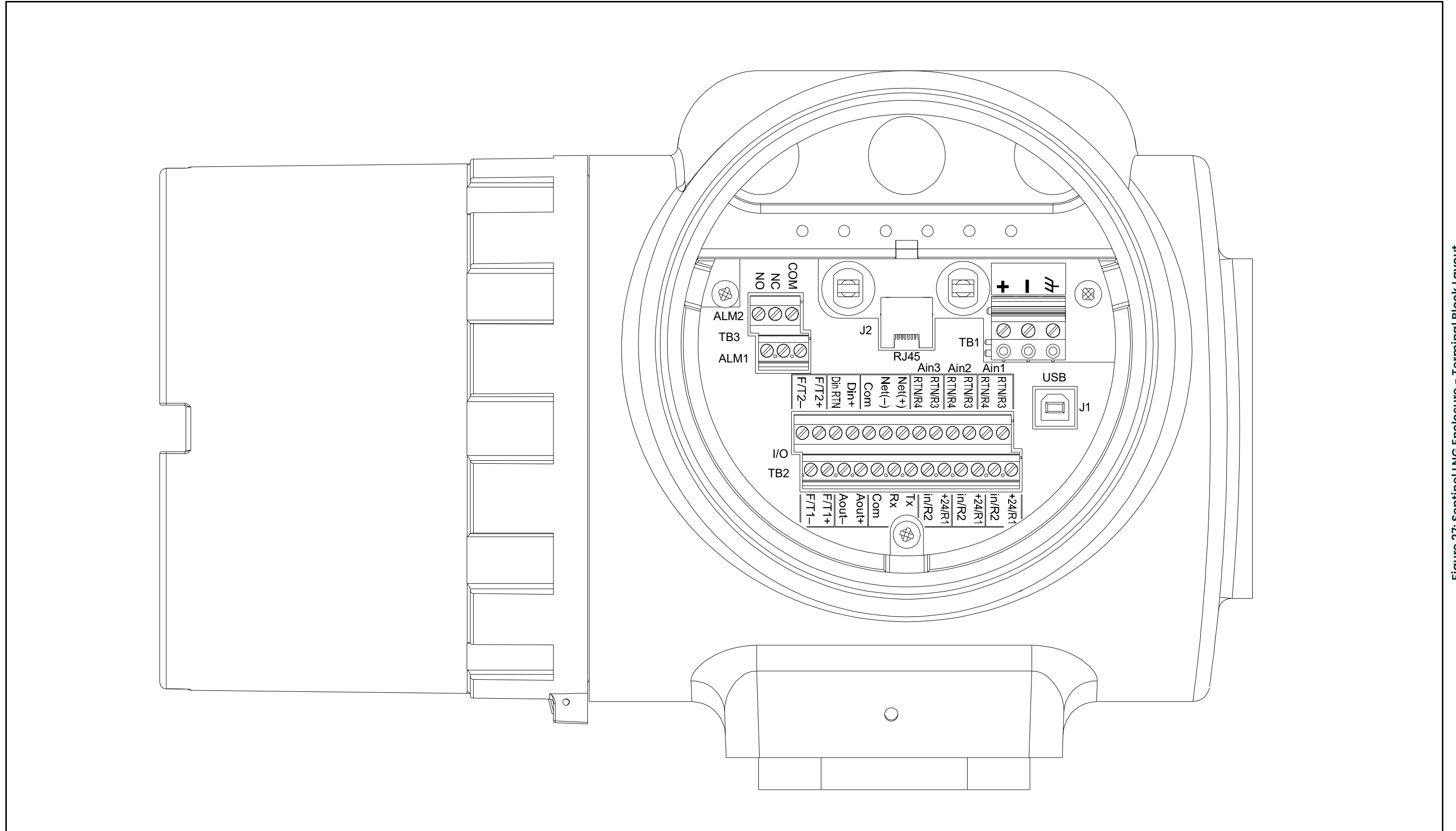

Figure 27: Sentinel LNG Enclosure - Terminal Block Layout

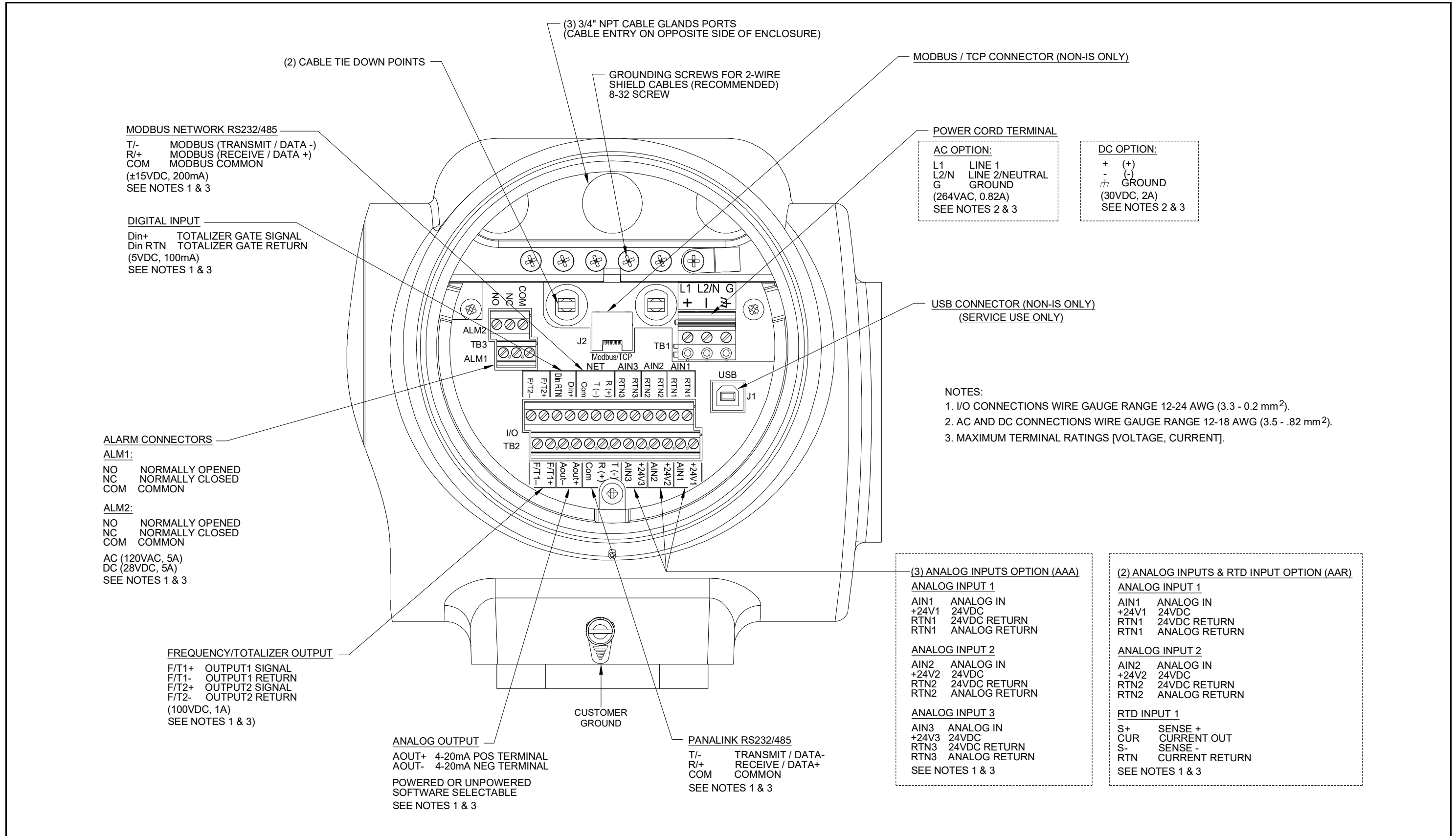

Figure 28: SEN898 Electronics – Wiring Diagram (ref. dwg #702-884)

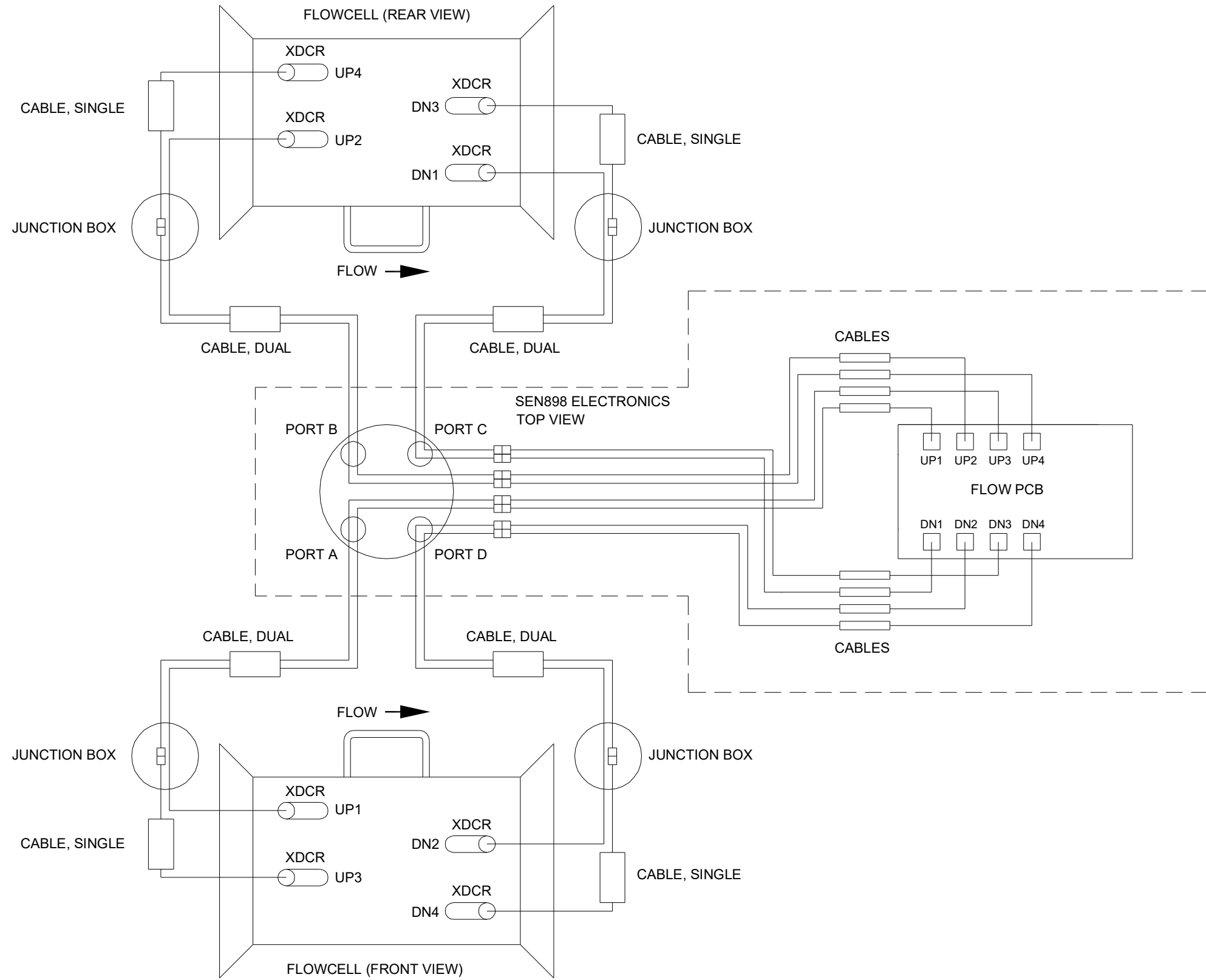

Figure 29: Sentinel LNG to SEN898 Electronics - Interconnection Diagram (ref. dwg #702-887)



## Chapter 3. General Programming

### 3.1 Introduction

The **Sentinel LNG** flow transmitter includes a User Program that provides access to the various programmable features of the instrument. This chapter describes step-by-step programming instructions using the internal keypad, shown in Figure 30 below.

### 3.2 Keypad Features

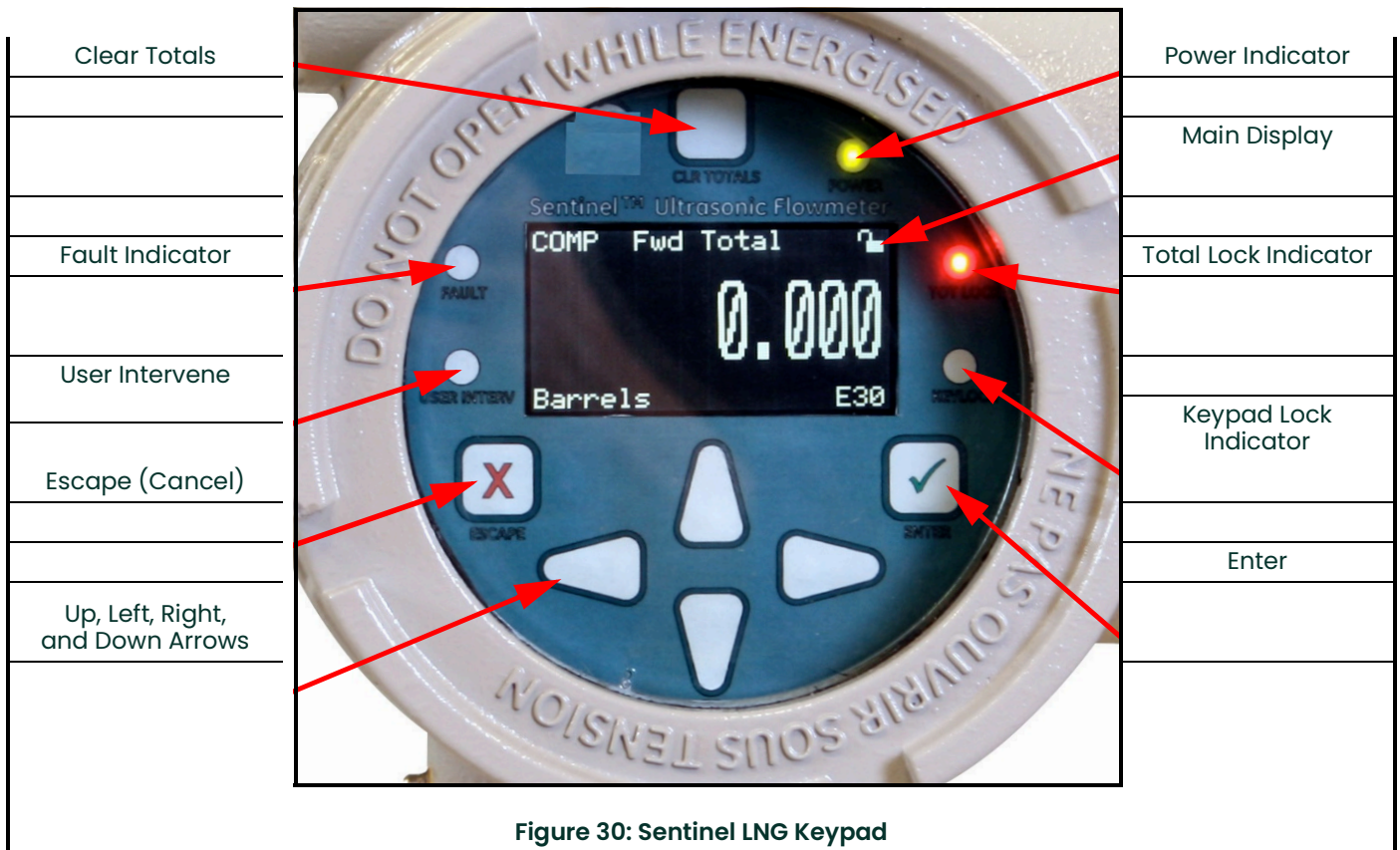

Figure 30: Sentinel LNG Keypad

The **Sentinel LNG** has seven keys: a **Clear Totals** key, four arrow keys, an **Escape** **X** key, and an **Enter** **✓** key.

- Use the **Escape** **X** key to open the main menu on the display. (If locked, see *Unlocking and Locking* on page 40.)
- Use the arrow keys to navigate among menu choices and to increment/decrement numeric entries.
- Use the **Escape** **X** key to cancel a numeric entry change, or exit a menu.
- Use the **Enter** **✓** key to accept a numeric entry or select a menu option.

### 3.2.1 Indicator Lights

If the **Fault Indicator** is lit, an instrument fault is detected. An error indication will be displayed in the lower right-hand corner of the Measurement View.

If the **User Intervene Indicator** is lit, an alarm has been triggered and will be kept latched until cleared by the user. See *Wiring the Alarm Relay* on page 25 and *Inputs/Outputs* on page 51 for more information.

The **Keypad Lock Indicator** will be lit if the Keypad Lock-Out Switch, internal to the instrument, has been engaged.

**Note:** *If the Keypad Lock Indicator is lit, the keypad will not be functional.*

The **Total Lock Indicator** will be lit if the Totals Lock-Out Switch, internal to the instrument, has been engaged.

**Note:** *If the Total Lock Indicator is lit, totals are not able to be reset by the Clear Totals Key or through programming.*

The **Power Indicator** is normally lit when the instrument is powered.

### 3.2.2 The Magnetic Stylus

Each of the keys can be selected using a hand-held magnet called a *Magnetic Stylus*, which is included with the meter. By touching the clear window at a key location, that key will be selected and will flash a red light to verify the contact.

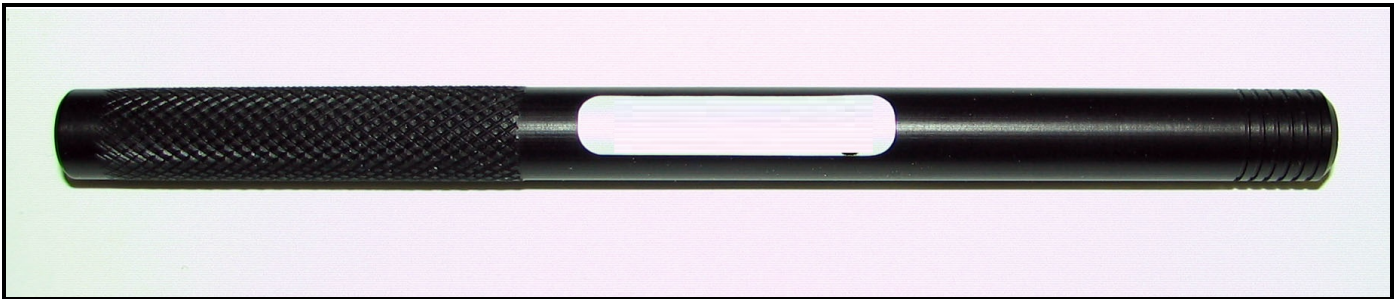

**Figure 31: Magnetic Stylus**

## 3.3 Program Menu Options

### 3.3.1 Channel Program

For the Channel Program setup, refer to the appropriate section for a discussion of the following PROG menu options, beginning on page 43.

- Status - activate or deactivate the channels/paths.
- Fluid - enter Reynolds Correction data (not supported at this time).
- Signal - enter the zero cutoff parameter.
- Error Limits - enter minimum and maximum signal, velocity, amplitude and soundspeed.

### 3.3.2 Composite Program

For the composite program setup, refer to the appropriate section for a discussion of the following Composite menu options, beginning on page 47.

- Fluid - enter fluid type in normal or Tracking Windows Mode.
- Signal - enter the number of errors allowed and the Compensation Status (additional option).
- Inputs - enter the temperature, pressure and density parameters.
- API Setup (additional option) - enter the table type and conditions.

### 3.3.3 Advanced Program

**Note:** *The Advanced Program is accessible only to persons with Field Service, Factory or Engineering status.*

For the advanced program setup, refer to Chapter 4, *Advanced Programming*.

- Transducer - enter data for preprogrammed or special clamp-on transducers
- K Factor - enter the Meter Correction (k) Factor as a single value or as a table of values
- Pipe - enter pipe parameters
- Weight Factors - enter the appropriate weight parameter.

To measure flow rate with the **Sentinel LNG**, activate the channel/path(s) and enter the transducer, pipe and fluid parameters. Appendix A includes a complete set of menu maps for the User Program, including Figure 231 on page 212 for the PROG menu.

**Note:** *This manual describes the programming of Channel 1, only. To program Channels 2 through 4, simply repeat the same procedures presented for Channel 1.*

## 3.4 Unlocking and Locking

To prevent unauthorized tampering with either the display or the user program, the **Sentinel LNG** has multiple security codes. Once the security level has been set, one of these codes is required to change just the display (Display Lock), or the display and the user program (Full Lock).

**Note:** To speed up the key response of the **Sentinel LNG**, deactivate CH1-CH4, as described on page 43. Remember to reactivate the channels when programming is complete.

### 3.4.1 Unlocking the Sentinel LNG

To unlock the display and/or the user program:

1. Press **[ESC]**, **[ENT]**, **[ESC]**. A Security Check window, similar to Figure 32 below, appears.



**Figure 32: Security Check Window**

2. Using the arrow keys, change the code number to the value desired for your security level. The security passcodes can be configured under USER<sup>®</sup> EDIT PASSCODES when the user is logged in as User Admin.

Full Lock	0000
Display Locked	2719
User 1	0001
User 2	0002
User 3	0003
User 4	0004
User Admin	0005
Field Service	----
Factory	----
Engineering/Unlock	----

3. Press **[ENT]**. The display screen reappears, with the lock removed, partially unlocked, or lettered to represent the level. Security will remain at this level until you change the level in the user program, as described on the next page, or if it times out and returns to full lock.

### 3.4.2 Locking the Sentinel LNG

The security level can be accessed in two ways.

From the display screen:

1. Press the [u] key three times, until the lock in the upper right corner is highlighted.
2. Press **[ENT]**, and proceed to step 4 below.

From the User Program:

1. Press **[ESC]**. The **Sentinel LNG** enters the User Program.
2. Press the [u] key until USER is bracketed.
3. Press the [q] key until Set Security is highlighted. Press **[ENT]**.
4. The screen shows up to ten options (depending on the current security level):
  - Full Lock – This will be the default level during meter power-up. Any User who wishes to access the menu will have to press the keys in the following combination (**Escape-Enter-Escape**) to unlock the meter with a “Valid Passcode”. The entered “Passcode” is validated and the user is allowed to access the menu based on privileges. The meter will go back to Full-Lock mode if no keypad activity is noted for a “Determined Time”.
  - Display Locked – This level can be achieved by entering a “Valid Passcode” assigned for this role. In this Mode/Level, the User has privilege only to view data. The User will be allowed to select the display parameters. Any other changeable parameter is denied access.
  - User-1 / User-2 / User-3 / User-4 – The User has to enter a “Valid Passcode” to have access to the menu attached to this role. The User with this role will have rights of Display Locked mode and some predetermined “write privilege” with which he may modify parameters (attached to this role).
  - User Admin – This User will have “Administrator privilege” in addition to privileges of Lower level. This user is given the rights to change the “Passcode” for all user-levels. (This does not include Full Lock and Display Locked). The Administrator has the privilege to modify the timeout value, which is used to determine the time taken to switch back to Full Lock mode (if no keypad activity is noted). The “Administrator privilege” does not include access to Service or Factory Menu. The Administrator has no rights or control on Service/Factory/Engineering Levels or their “Passcodes”.
  - Field Service – This User has access to the “Service Menu” in addition to “Administrator privilege”. It is not accessible by User Admin.
  - Factory – This User has access to “Factory privilege” in addition to “Service privileges”. It is not accessible by User Admin.
  - Engineering – This User is the only user with Full access to the meter. Only this user has rights to change the “Passcodes” for Factory and Service. It is not accessible by User Admin.

### 3.4.2 Locking the Sentinel LNG (cont.)

Scroll to the desired option and press **[ENT]** twice.

5. Press **[ESC]** to return to the User Program, or continue pressing **[ESC]** to return to the display screen. If you have chosen to fully lock the **Sentinel LNG**, the screen appears similar to Figure 33 below, with a solid lock in the upper right corner. (For a meter with only the user program locked, the lock shows a keyhole in the center.)



Figure 33: Screen with Locked Program

## 3.5 Setting Security

### 3.5.1 Edit Passcodes

This User option is made available only to Security Levels of User-Admin, Field Service, Factory and Engineering (see Table 8 on page 4 and the Security Level descriptions on page 41). On selection, the Passcodes for User-1 to User-4 and User-Admin can be modified. The Passcodes for Field Service, Factory, Engineering, Full-Lock and Program-Lock cannot be customized.

### 3.5.2 Security Timeout

This User option is made available only to Security Levels of User-Admin, Field Service, Factory and Engineering (see Table 8 on page 4 and the Security Level descriptions on page 41). This option enables the Admin, Field Service, Factory and Engineering users to set a timeout period, after which the meter will switch back to Full-Lock mode, if no keypad activity is noted. The Timeout ranges from 1 minute to 60 minutes. The Security Timeout period set is applicable only for User-1 to User-Admin. For other Security Levels, the Timeout period is invalid.

### 3.5.3 Set Security

The User is allowed to set a security level below the current level.

## 3.6 Channel Programming

### 3.6.1 Activating a Channel/Path/CHX (Status)

Use the Status submenu of the PROG menu, to activate or deactivate a channel/path. The channel/path should be activated when the unit is received, however, it should be verified that the channel/path is active before data is acquired. While following the programming instructions, refer to Figure 231 on page 212. Remember to record all programmed data in Appendix C, *Data Records*.

To access the Status submenu:

1. Press **[ESC]**. The **Sentinel LNG** enters the User Program.
2. Press the [u] key until PROG is bracketed in the top left corner and press **[ENT]**.
3. Use the [p] and [q] keys to scroll to the desired channel and press **[ENT]**. The screen appears similar to Figure 34 below.

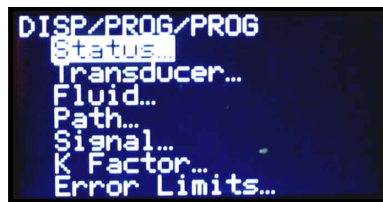

Figure 34: The PROG Menu

4. Press **[ENT]** to open the Status submenu.



Figure 35: The Status Menu

5. The screen offers two options, ON and OFF. Use the [p] and [q] keys to scroll to the desired selection and press **[ENT]**.

**Note:** On any menu, if you scroll to a different option, press **[ENT]** twice to select it (once to enter and again to confirm).

6. Press **[ESC]** (or **[ENT]** twice if you have selected the other option) to return to the channel menu.

After the above steps are completed, the user program returns to the PROG menu. Do one of the following:

- To program in other menus, refer to Appendix A, *Menu Maps*, to navigate to the desired menu.
- To leave the User Program, press **[ESC]** three times.

### 3.6.2 Entering Fluid Data (Not supported at this time)

The Fluid submenu enables selection of the Reynolds Correction factor. While following the programming instructions, see Figure 231 on page 212. Remember to record all programmed data in Appendix C, *Data Records*.

**Note:** From the **PROG** menu, proceed directly to Step 4. To select a different option, scroll to that option and press **[ENT]** twice to select it (once to enter and again to confirm the selection).

To access the Fluid submenu:

1. Press **[ESC]**. The **Sentinel LNG** enters the User Program.
2. Press the [u] key until **PROG** is bracketed in the top left corner and press **[ENT]**.
3. Use the [p] and [q] keys to scroll to the desired Channel and press **[ENT]**.
4. Scroll to the Fluid submenu and press **[ENT]**. The word Reynolds appears.

#### 3.6.2.1 Reynolds Correction Data

Reynolds Correction is a correction factor based on the Kinematic Viscosity and flow rate of the fluid. It is necessary, as the velocity of the fluid measured along a diametrical path must be related to the total area average velocity over the entire pipe cross-section. This factor should be ON in most applications, including all those that use clamp-on transducers. To access Reynolds Correction data:

1. From the Fluid window, select Reynolds and press **[ENT]**. The screen shows three options: Off, Single and Table.
2. Scroll to the desired option, and press **[ENT]**. The menu varies, depending on the selection in Step 1.
  - If Off is chosen, no further choices are available.
  - If Single is chosen, the **Sentinel LNG** will select and automatically display the Kinematic Viscosity. To change the value, press **[ENT]**. Use the arrow keys to change the value (available in document #914-004, *Soundspeeds and Pipe Size Data*), and press **[ENT]**.
  - If Table is selected, the screen displays four options: Units, Rows Used, Edit Table and Reset Table.
    - a. Select Units and press **[ENT]** and the screen displays two more options: Soundspeed and Diagnostic. Select Soundspeed and press **[ENT]** and the screen displays Meters/sec. Press **[ESC]** or **[ENT]** to return to the previous screen. Select Diagnostic and press **[ENT]** and the meter requests the type of signal to be used, Signal Up or Signal Dn. Scroll to the appropriate signal, and press **[ENT]**.
    - b. From the Unit Menu, select Rows Used and press **[ENT]**. Use the arrow keys to enter the desired number (from 2 to 20) and press **[ENT]**.
    - c. Select Edit Table and press **[ENT]**, and the table opens with a series of rows. Scroll to the desired row, and press **[ENT]**.
    - d. For each row, the screen displays the Reynolds Correction number (X) and the Kinematic Viscosity (KV). If you wish to change either value, scroll to the value and press **[ENT]**. Use the arrow keys to change the value (available in *Soundspeeds and Pipe Size Data*, document #914-004), and press **[ENT]**.
    - e. Repeat steps **c** and **d** until all available data (from 2 to 20 rows) has been programmed.
    - f. Press **[ESC]** to return to the **PROG** menu, or continue pressing **[ESC]** until the display screen reappears.
    - g. To confirm changes to the table, from the Unit Menu, select Reset Table... and press Enter. To reset the table select Yes and press Enter. To not reset the table, select No and press Enter.

### 3.6.3 Entering Signal Parameters

In the Signal submenu, set parameters that affect the transducer signal:

**CAUTION!** The **SIGNAL** default settings are suitable for most applications. Consult the factory before changing any of these settings.

**Note:** Under **Channel Programming**, the only signal parameter that can be changed is Zero Cutoff.

While following the programming instructions, refer to Figure 231 on page 212.

**Note:** From the **PROG** menu, proceed directly to Step 4. To select a different option, scroll to that option and press **[ENT]** twice to select it (once to enter and again to confirm the selection).

To enter the Signal submenu:



1. Press **[ESC]**. The **Sentinel LNG** enters the User Program.
2. Press the [u] key until PROG is bracketed and press **[ENT]**.
3. Use the [p] and [q] keys to scroll to the desired Channel and press **[ENT]**.
4. Scroll to the Signal option and press **[ENT]**.
5. The prompt requests the Zero Cutoff. Near “zero” flow, the **Sentinel LNG** may have fluctuating readings due to small offsets (caused by factors such as thermal drift in the fluid). The zero cutoff causes velocity measurements less than the cutoff to be reported as zero. To set the cutoff, press **[ENT]**, and use the arrow keys to enter the new value. Press **[ENT]** to confirm the entry.

Entering parameters in the Signal option has been completed. Press **[ESC]** to return to the PROG menu, or continue pressing **[ESC]** until the display screen reappears.

### 3.6.4 Entering Error Limits

The Error Limits option enables setting limits for an incoming signal. When the signal falls outside the programmed limits, an error indication appears on the display screen. To set error limits, follow the steps below.

**Note:** From the **PROG** menu, proceed directly to Step 4. To select a different option, scroll to that option and press **[ENT]** twice to select it (once to enter and again to confirm the selection).

1. Press **[ESC]**. The **Sentinel LNG** enters the User Program.
2. Press the [u] key until **PROG** is bracketed in the upper left corner and press **[ENT]**.
3. Use the [p] and [q] keys to scroll to the desired Channel and press **[ENT]**.
4. Scroll to the Error Limits option and press **[ENT]**.
5. The first prompt requests the Min Signal limit for the transducer signal received by the **Sentinel LNG**. The E1:LOW SIGNAL error message appears if the signal strength falls below the limit programmed here. Press **[ENT]**. Use the arrow keys to change the value and press **[ENT]**.
6. Repeat the steps above for the Max Signal limit.
7. The next prompt calls for the Min Velocity limit. Press **[ENT]**. Use the arrow keys to change the value and press **[ENT]**.
8. Repeat the steps above to change the Max Velocity limit. (The E3:VELOCITY RANGE error message appears if the velocity falls outside the minimum and maximum limits.)
9. The meter now requests the Min Amplitude, the lower limit for the amplitude discriminator. The discriminator measures the size of the transducer signal sent from the **Sentinel LNG**. If the signal falls outside these limits, the E5:AMPLITUDE error message appears. Press **[ENT]**. Use the arrow keys to change the value and press **[ENT]**.
10. Repeat these steps for the Max Amplitude, the upper limit for the discriminator.
11. The next prompt calls for the acceptable Soundspeed limits, based on conditions in the particular system. The E2:SOUNDSPEED error message appears if the fluid soundspeed exceeds that entered in the Fluid submenu by more than this percentage. Press **[ENT]**. Use the arrow keys to change the percentage and press **[ENT]**.
12. The final prompt requests the Acceleration limit for detecting cycle skipping. The E6:ACCELERATION error message appears if the velocity changes by more than this limit from one reading to the next. Press **[ENT]**. Use the arrow keys to change the value and press **[ENT]**.

You have finished entering data in the **PROG** menu. Do one of the following:

- To program in other menus, refer to Appendix A, *Menu Maps*, to navigate to the desired menu.
- To return to the display screen, press **[ESC]** until the display screen reappears.
- To configure the display, proceed to the next chapter.

## 3.7 Composite Programming

Under the PROG menu, select Composite... and press [ENT].

### 3.7.1 Entering Fluid Type

1. Scroll to Fluid Type and press [ENT]. Two other options appear, Normal and Tracking. Tracking refers to Tracking Windows, which are used to detect the receive signal when you are unsure of the fluid soundspeed, or when the fluid soundspeed changes drastically under process conditions.
2. Scroll to the desired option and press [ENT].
3. Make a selection between Preprogrammed and Other fluids. Scroll to the desired option, and press [ENT].
  - For Normal fluids, the expected fluid Temperature can be programmed. Scroll to the Temperature option and press [ENT]. Then use the arrow keys to enter the process temperature, and press [ENT].
  - For fluids monitored with a Tracking Window, the meter enables the selection of Water (up to 100° or 260°C) or Oil. Scroll to the desired listing and press [ENT].
4. The menu now varies, depending on the selections in steps 6 and 7.
  - If Preprogrammed Fluids has been selected, the **Sentinel LNG** supplies a list of preprogrammed fluids. As shown in Table 1 below, the list varies, depending on whether you have selected normal or tracking window fluid types. In either case, scroll to the desired fluid and press [ENT].
  - If Other was selected, the **Sentinel LNG** requests the fluid soundspeed (for Normal fluids) or minimum and maximum soundspeed (for Tracking Window fluids). In either case, scroll to the Soundspeed option and press [ENT]. Use the arrow keys to enter the appropriate soundspeed, and press [ENT].

**Table 1: Preprogrammed Fluid Types**

Water (0-260°C)	Lube Oil (X200)	Freon (R-12)	Water (0-100°C)
Sea Water	Methanol (20°C)	Diesel	Water (0-260°C)
Oil (22°C)	Ethanol	Gasoline	Oil
Crude Oil	LN2 (-199°C)		

5. Press the [ESC] key to return to the Fluid Type window.

### 3.7.2 Entering Signal Parameters

In the Signal submenu, set parameters that affect the transducer signal:

**CAUTION!** The **SIGNAL** default settings are suitable for most applications. Consult the factory before changing either of these settings.

- Error Allowed
- Compensation Status (additional option)

While following the programming instructions, refer to Figure 231 on page 212.

**Note:** From the **COMPOSITE** menu, proceed directly to Step 4. To select a different option, scroll to that option and press **[ENT]** twice to select it (once to enter and again to confirm the selection).

To enter the Signal submenu:

1. Press **[ESC]**. The **Sentinel LNG** enters the User Program.
2. Press the [u] key until **PROG** is bracketed and press **[ENT]**.
3. Use the [p] and [q] keys to scroll to **Composite** and press **[ENT]**.
4. Scroll to the **Signal** option and press **[ENT]**.
5. Select **Error Allowed**, press **[ENT]**, use the arrow keys to enter the new value, and press **[ENT]** to confirm the entry.
6. If **Dimensional Compensation** is an included option, at the next parameter, **Compensation Status**, the screen shows the two options, **On** or **Off**. Scroll to the desired option, and press **[ENT]**.

Entering parameters in the Signal option has been completed. Press **[ESC]** to return to the **PROG** menu, or continue pressing **[ESC]** until the display screen reappears.

### 3.7.3 Setting Up Input Data Feeds

In the Inputs submenu, set the status for three types of inputs:

- Temperature
  - Pressure
  - Density
1. From the **COMPOSITE** menu, select **Inputs**, and press **[ENT]**. The next screen lists three types of inputs: **Temperature**, **Pressure**, and **Density**.
  2. Select the input to be changed and press **[ENT]**. The input status is described by two options: **Fixed** or **Active**.
  3. To experience a stationary input, select **Fixed**, and press **[ENT]**. Press **[ENT]** again to reveal the **Fixed** input value.
  4. To set a different value, use the arrow keys to change the digits, and press **[ENT]**.
  5. To experience an active input, select **Active**, and press **[ENT]**. Press **[ESC]** to return to the previous menu.

### 3.7.4 Setting Up API

In the API Setup submenu, set the table types and conditions for several API options:

1. If the API option is included, from the COMPOSITE menu, select API Setup, and press [ENT]. The next screen displays API Table Type and API Conditions.

#### 3.7.4.1 API Table Type

1. Select API Table Type and press [ENT]. The next screen displays four table types: Table A-Crude or JP, Table B-Gen Product, Table C-User Def TE, and Table D-Lubricants.
2. For Tables A, B and D, select a specific table, press [ENT], and the screen returns to the API Setup menu.
3. Select Table C, press [ENT], and the Thermal Exp Coeff screen appears. To change the coefficient, press [ENT]. On the next screen, use the arrow keys to change the digits, and press [ENT] to save the change, or [ESC] to reject the change. The screen returns to the previous display. Press [ESC] twice to return to the API Setup display.

#### 3.7.4.2 API Conditions

1. Select API Conditions. Press [ENT]. The next screen displays two options: Base Condition and Flow Measure At...
2. Select Base Condition and press [ENT]. The next screen displays four options: 60°, 20°, 15° and User Defined... Select a given temperature or define a new one.
3. To establish a new base temperature, select User Defined, press [ENT], and the User Def Base Temp screen appears. Press [ENT], and the User Defined temperature is able to be changed.
4. Using the arrow keys, change the appropriate digits, and press [ENT]. Press [ESC] twice and return to the APIcond screen.
5. Select Flow Measure At... and press [ENT]. A screen appears listing two options: Observed and Alternate...
6. To measure at Observed, select Observed and press [ENT]. Two settings appear: Temp(alt) and Pres(alt).
7. To change either alternate condition, select the option, and press [ENT].
8. Using the arrow keys, change the appropriate digits, and press [ENT].
9. Change the other alternate condition if needed, and press [ESC] to return to the Flow Measurement At... screen.
10. To measure at Alternate, select Alternate and press [ENT]. Three settings appear: Temp(obs), Pres(obs), and Dens(obs).
11. To change an observed condition, select the option, and press [ENT].
12. Using the arrow keys, change the appropriate digits, and press [ENT].
13. Change the other observed conditions if needed, and press [ESC] four times to return to the PROG menu.

## 3.8 Configuration

1. From the main menu, use the right arrow key to scroll to CONFIG. The screen displays five options: Units, Communication, Reset Totals, Totalizer Errors and Date/Time. Use the arrow keys to select an option to be configured.
2. To choose a measurement type, select Units, and press [ENT]. The screen displays Metric and English. Select one, press [ENT] and the screen returns to the CONFIG menu.
3. To choose a communication type, select Communication and press [ENT]. The screen displays three options: Panalink, Modbus (if option is included) and HART.
4. Select the desired communication software, press [ENT], and set up the components by making the appropriate selections from each list of options.
5. To reset the totals, from the CONFIG menu, select Reset Totals and press [ENT].

**Note:** *If the totalizer lock is enabled, the previous totals will not be cleared.*

- a. Select a Channel, the Composite setup, or All, and press [ENT].
  - b. From the next menu, select whether to reset the forward total, the reverse total, or both, and press [ENT].
  - c. Press [ESC] to return to the CONFIG menu.
6. To set up error handling, from the CONFIG menu, select Totalizer Errors, and press [ENT].
  - a. Select a Channel or the Composite setup and press [ENT].
  - b. Answer the question, Totalize on Error?, by selecting Yes or No. Then press [ENT].
  - c. Repeat the process for other channels, if necessary, and press [ESC] to return to the CONFIG menu.
7. To reset the date and/or time, from the CONFIG menu, select Date/Time, and press [ENT].
  - a. Press [ENT] again to edit the text.
  - b. Use the arrow keys to select and change numbers in the date/time format.
  - c. Press [ENT] to accept the change.

## 3.9 Inputs/Outputs

From the main menu, use the arrow keys to scroll to IO. The screen displays five options. Use the arrow keys to select an option to be configured.

- Analog Outputs
- Freq/Totals
- Alarms
- Slot 1
- Slot 2

While following the programming instructions, refer to Figure 234 on page 215 or Figure 235 on page 216.

**Note:** From the IO menu, proceed directly to Step 3. To select a different option, scroll to that option and press [ENT] twice to select it (once to enter and again to confirm the selection).

To enter the IO Menu:

1. Press [ESC]. The **Sentinel LNG** enters the User Program.
2. Press the [>] key until IO is bracketed and press [ENT].
3. Use the [^] and [v] keys to scroll to wanted IO option

### 3.9.1 Analog Outputs

1. Select Analog Output to bring you to the menu.
2. Select Status. Select Off to disable output or On to enable output.
3. Select the Channel of the data source you want to output.
4. Select the Publisher you want to output.
5. Select the Units for the Publisher output.
6. Enter a value for the Base (low end) of the chosen output range that corresponds to a 4mA output.
7. Enter a value for the Span (high end) of the chosen output range that corresponds to a 20mA output.
8. Choose the Error Level, the way the output will respond during an error condition:

Option	Output Response
Hold Value	Holds the last "good" reading.
Force Hi (20mA)	Forces Output to 20mA.
Force Lo (4mA)	Forces Output to 4mA.
Force HH	Forces Output to 21mA
Force LL	Forces Output to 3.8mA
Force Value	Enables the user to enter a value between 4mA and 20mA, to be output during an error.

9. Select Mode, either Passive or Active.

### 3.9.2 Frequency/Totalizers

1. Select Freq/Totals to bring you to the menu.
2. Select Linked or Independent

**Note:** If you select *Linked*, both outputs will be setup the same, just 90° out of phase. If you select *Independent*, you will set up each output separately.

3. Select Freq/Total #1.
  - a. Status-Select On or Off
  - b. Mode-Select Frequency or Totalizer

## c. Drive Ctl-Select Open Drain or Push-Pull

**3.9.2.1 Frequency**

1. Units - Choose the channel, parameter and units to output.
2. Fbase - Enter the lowest value of the Frequency range you want to output.
3. Fspan - Enter the highest value of the Frequency range you want to output.
4. Value(min) - Enter the value of the parameter you want to correspond to the min. value of the frequency range.
5. Value(max) - Enter the value of the parameter you want to correspond to the max. value of the frequency range.
6. Choose the Error Level, the way the output will respond during an error condition. Choose Force LO, Force HI, Hold Last, or Force Value. When the meter goes into Error, the choosen Error level will be output through the Frequency Output.:

Option	Output Response
Force Lo	Forces Output to Fbase.
Force Hi	Forces Output to Fspan.
Hold Last	Holds the last "good" reading.
Force Value	Enables the user to enter a value between the Frequency Range, to be output during an error.

**3.9.2.2 Totalizer**

1. Units - Choose the channel, parameter and units to output
2. Unit/Pulse - Choose how many units of the chosen parameter are accumulated until a pulse is sent out.
3. Pulse Width - Choose the length of each pulse output.

**Note:** *Make sure the meter is not going to be outputting more than one pulse during this time, as this could lead to missed pulses.*

4. Polarity - Choose the Negative or Positive edge of the pulse.



### 3.9.3 Alarms

1. Select Status, and choose either OFF, Normal, or Failsafe.

- a. OFF - Disables alarm functionality.
- b. Normal - Selection for conventional operation.
- c. Failsafe - Selection for fail-safe operation.

2. If Normal or Failsafe has been chosen, select Type.

- a. Level

Units - Defines the Unit of Measure for the alarm.

Trip Point - Defines the level where the alarm trips.

Dead Band - Defines the amount past the trip point where the alarm resets.

Trip Direction - Defines the direction of the alarm trip, above the set Trip Point or Below the set Trip Point

Error Level -

Reset - Reset would force the alarm state to reset on error or fault condition. Reset would be such that NO would be NO, unless configured for failsafe.

Trip - Trip would force the alarm to Trip direction on error or fault condition.

Hold Last - Hold Last would hold the current state of the alarm on an error or fault condition.

- b. Direction

The alarm can be tripped on forward or reverse flow. It uses volumetric in  $m^3/s$ . The alarm will look for a positive or negative change in this flow reading.

- c. Fault Alarm

Trips the alarm on a particular fault, like E1 or E2. Can configure for individual faults, all faults or flow faults.

3. Choose Latch State

- a. Latch - Enables the alarm to hold its state. This selection causes the User Intervene Indicator to be lit when an alarm occurs.
- b. No Latch - The alarm is reset when the error condition clears.
- c. Clear Latch - Changes the latched state. This will turn off the User Intervene Indicator if the meter is no longer in error.

### 3.9.4 Analog Inputs (Additional Option)

If an option card is installed, Analog Inputs are available to the user.

1. Select the appropriate Slot for the Option Card.
2. Select the Ain item that you want to set up.
3. Enter a Value for the Label if you want it changed.
4. Select Mode and choose Off to turn off the input, or choose Temperature, Pressure or Density to set it up as one of those inputs.
  - a. Choose the Units for the input.
  - b. Enter the Base (low end) of the input.
  - c. Enter the Span (high end) of the input.
5. Select Cal to Trim the inputs.

If a Calibration is not going to be performed, load nominal calibration values by selecting Reset Trim. This will enable 4-20 to be read with undetermined accuracy. In order to meet accuracy, a proper Calibration must be performed.

- Make sure the inputs are wired correctly according to Figure 28 on page 35.
- Set the input to 4mA, for the Low end.
- Select Trim Base.
- Select Yes.
- Set the input to 20mA, for the High end.
- Select Trim Span.
- Select Yes.
- Calibration is complete.

### 3.9.5 RTD (Additional Option)

If an option card is installed, an RTD Input may be available to the user, depending on the option card ordered.

1. Select the appropriate Slot for the Option Card.
2. Select the Temp(RTD) option
3. Enter in a Value for the Label if you want it changed
4. Select Mode and choose Off to turn off the input, or choose Temperature and select the input Temperature units.
5. Select CAL.
  - a. Make sure the RTD is connected to the terminal board correctly, according to Figure 28 on page 35.
  - b. Panametrics Sensing's calibration process involves using a temperature bath and an iRTD (reference).
  - c. The iRTD is connected to iRTD Win Software to read the values.
  - d. The Meter is set up to display 1C:RTD.
  - e. Under IO/Slot 1/1C:Temp(RTD)/Mode choose temperature and enter in the right units.
  - f. A 2 to 5 point calibration is allowed with **Sentinel LNG**.

Cal points must be entered with the lowest temperature starting at setpoint #1, and in increasing order to the highest setpoint.

Cal points must be performed over the full range to be measured. Temperatures that are out of the calibrated range (not on or between the highest and lowest setpoints) will not have calibration information applied to them

and will not be corrected. "Falling off of the cal range," or increasing the temperature beyond the last setpoint could cause data to be discontinuous.

Empty locations in the calibration table should be filled with the value '0'.

- g. The Setpoint is the actual temperature that you are trying to read.
  - h. The Offset is the temperature the meter is reading from the probe minus the reference reading.
  - i. Run all points with the values set to 0, and then fill them in when all cal points are complete.
6. Select Reset Table if you want to return all Calibration Entries back to 0.

### 3.10 Display

1. From the main menu, use the arrow keys to scroll to DISP. The screen displays four options: Views, Contrast, Backlight, and Mode. Use the arrow keys to select an option to be configured.
2. To set up display Views, select it, and press [ENT]. 1 View and 2 Views appear as options.
3. Move through the categories and set up each view as desired. Press [ESC] to return to the DISP menu.
4. To change the display Contrast, select it, and press [ENT]. Using the arrow keys, change the percentage digits as desired, and press [ENT]. The screen returns to the DISP menu.
5. To change the display Backlight, select it, and press [ENT]. Using the arrow keys, change the percentage digits as desired, and press [ENT]. The screen returns to the DISP menu.
6. To change the display Mode, select it, and press [ENT]. Select Normal or Reverse and press [ENT]. The screen returns to the DISP menu.

### 3.11 Calibration

1. Connect the Analog Output to an ammeter.
2. From the main menu, use the arrow keys to scroll to CAL. The screen displays one option: 4-20 Loop. Press [ENT] and four categories appear: Base Trim, Span Trim, Percent and Mode.
3. Select Mode, press [ENT], and select Test(Trim).
4. Set the percentage to 0% and press [ENT].
5. Select Base Trim, press [ENT], and using the arrow keys, enter what the ammeter is reading.
6. Set the percentage to 100% and press [ENT].

7. Select Span Trim, press [ENT], and using the arrow keys, enter what the ammeter is reading.
8. Go to Mode and select Normal.
9. Calibration of the 4-20mA Output Loop is complete.

## 3.12 User Security

- From the main menu, use the arrow keys to scroll to USER. The Edtcd screen displays three options: Edit Passcodes, Security, and Set Security.

### 3.12.1 Edit Passcodes

This User option is made available only to Security Levels of User-Admin, Field Service, Factory and Engineering (see Table 8 on page 4 and the Security Level descriptions on page 41). On selection, the Passcodes for User-1 to User-4 and User-Admin can be modified. The Passcodes for Field Service, Factory, Engineering, Full-Lock and Program-Lock cannot be customized.

- To enter or edit user passcodes, select Edit Passcodes, and press [ENT]. Select the USER/ADMIN number to be added or changed, and press [ENT]. Use the arrow keys to add or change the appropriate digits, and press [ENT].

### 3.12.2 Security Timeout

This User option is made available only to Security Levels of User-Admin, Field Service, Factory and Engineering (see Table 8 on page 4 and the Security Level descriptions on page 41). This option enables the Admin, Field Service, Factory and Engineering users to set a timeout period, after which the meter will switch back to Full-Lock mode, if no keypad activity is noted. The Timeout ranges from 1 minute to 60 minutes. The Security Timeout period set is applicable only for User-1 to User-Admin. For other Security Levels, the Timeout period is invalid.

- To change the Security Timeout, select Security, and press [ENT]. Use the arrow keys to change the appropriate digits, and press [ENT].

### 3.12.3 Set Security

The User is allowed to set a security level below the current level.

- To set or change the security level, select Set Security, and press [ENT]. The screen lists ten options: Full Lock, Display Locked, User1 through 4, User Admin, Field Service, Factory, and Engineering. Select the appropriate level of security and press [ENT].

## 3.13 Factory Status

1. From the main menu, use the arrow keys to scroll to FACTORY. The screen displays five options: Versions, Default Meter, Upgrade, System Info, and Tag.
2. To set the version type, select Versions, and press [ENT]. The screen displays two options: Main and Option Cards.
3. Select Main, and press [ENT], and the screen displays Version Info. Press [ESC] and the screen returns to the Versions menu.
4. Select Option Cards, and press [ENT], and the screen displays Option Card Version Info. Press [ESC] and the screen returns to the Versions menu. Press [ESC] to return to the FACTORY menu.

**IMPORTANT:** Do not return the meter to default settings without speaking to someone at the factory first.

5. To return the meter to the default settings, from the FACTORY menu, select Default Meter and press [ENT]. Select Yes to confirm or No to cancel, and press [ENT]. The screen returns to the FACTORY menu.

**IMPORTANT:** Do not upgrade the meter's code without speaking to someone at the factory first.

6. To upgrade the meter's code, from the FACTORY menu, select Upgrade, and press [ENT]. Select Yes to confirm or No to cancel, and press [ENT]. The screen returns to the FACTORY menu.
7. To access system information, select System Info, and press [ENT]. The screen displays DATE/TIME and UpTime. Press [ESC] to return to the FACTORY menu.
8. To change the Tag, select the given name, and press [ENT]. Use the arrow keys to change the letters to the new name Tag. When complete, press [ENT], and the screen returns to the FACTORY menu.

## Chapter 4. Advanced Programming

**Note:** The Advanced Program is accessible only to persons with Field Service, Factory or Engineering status.

The Advanced Program enables the entry of parameters in the following categories:

- Transducer – enter data for preprogrammed or special clamp-on transducers
- K Factor – enter the Meter Correction (K) Factor as a single value or as a table of values
- Pipe – enter pipe parameters
- Weight Factors – enter the appropriate weight parameter.

To measure flow rate with the Sentinel LNG, activate the channel/path(s) and enter the transducer, pipe and fluid parameters. Appendix A includes a complete set of menu maps for the User Program, including Figure 231 on page 212 for the PROG menu.

### 4.1 Entering Transducer Parameters

To enter parameters for preprogrammed or special clamp-on transducers, use the Transducer menu. Remember to record all programmed data in Appendix C, *Data Records*.

To access the Transducer submenu, from the main screen:

1. Press [ESC]. The Sentinel LNG enters the User Program.
2. Press the [▶] key until **PROG** is bracketed in the top left corner and press [ENT].
3. Use the [▲] and [▼] keys to scroll to the desired Channel and press [ENT].
4. Scroll to the Transducer submenu and press [ENT]. **Clamp-on and Wetted options appear.**

#### 4.1.1 Clamp-On Transducers

1. To set up Clamp-on transducers, scroll to Clamp-on and press [ENT].
2. Scroll to either Preprogrammed (for the standard transducers) or Other (for special transducers), and press [ENT].
3. The program also calls for the Wedge Temperature. Scroll to the Wedge TMP option and press [ENT]. Then use the [▲] and [▼] keys to enter the temperature, and press [ENT].

**Note:** The wedge temperature of the transducer can be approximated by inputting an average value for the surface temperature of the outside pipe wall.

4. Do one of the following:
  - For preprogrammed transducers, scroll to the desired Transducer Number (407 [2 MHz], 408 [4 MHz], 409 [500 kHz] or 410 [1 MHz]) and press [ENT]. Then press [ESC] three times to return to the PROG menu.
  - For other Clamp-on transducers, proceed to *Other Transducers* on the next page.

**IMPORTANT:** Other (special) transducers have no engraved number on the housing and are rarely used. Examine the transducer housing carefully for a number.

#### 4.1.2 Other Transducers

1. The first required parameter is the Frequency. Press [ENT] to open the Frequency window. Then scroll to the frequency of your transducer (from 0.25 to 4.00 MHz) and press [ENT].
2. The meter next asks for the Time Delay ( $T_w$ ). Scroll to the  $T_w$  option and press [ENT]. Then use the arrow keys to enter the time provided by Panametrics Sensing (in microseconds), and press [ENT].
3. The next parameter is the Wedge Angle, the angle of the transducer's ultrasonic transmission in the transducer wedge. Scroll to the Wedge Ang option and press [ENT]. Use the arrow keys to enter the provided angle (in degrees), and press [ENT].
4. To enter the Wedge Soundspeed, scroll to the Wedge SS option and press [ENT]. Use the arrow keys to enter the provided soundspeed (in m/s or ft/s), and press [ENT].
5. The final parameter is the Temperature Coefficient. Scroll to the TempCo option and press [ENT]. Use the arrow keys to enter the provided coefficient, and press [ENT]. Set the coefficient to 0 if you are unsure of the value.

Entering parameters for other transducers is complete. Press **[ESC]** to reach the **PROG** menu and continue programming, or continue pressing **[ESC]** to resume displaying data.

### 4.1.3 Wetted Transducers

1. To set up Wetted transducers, select Wetted from the Transducer submenu and press **[ENT]**.
2. Scroll to either Preprogrammed (for the standard transducers) or Other (for special transducers), and press **[ENT]**.
3. For preprogrammed transducers, scroll to the desired Transducer Number (BWT [500kHz], #51 [1 MHz], or #52 [2MHz] and press **[ENT]**. Then press **[ESC]** three times to return to the PROG menu.
4. For Other transducers, from the Wetted menu select Other and press Enter.
5. To change the frequency select Frequency, scroll to the desired frequency value and press Enter.
6. To change the Time Delay, select Tw... and press Enter.
7. Using the arrow keys, change the time delay as needed, then press Enter.

## 4.2 Entering Path Data

In the Path submenu, specify and check the path taken by the transducer signal. Remember to record all programmed data in Appendix C, *Data Records*.

**Note:** From the **PROG** menu, proceed directly to Step 4. To select a different option, scroll to that option and press **[ENT]** twice to select it (once to enter and again to confirm the selection).

To access the Path submenu:

1. Press **[ESC]**. The Sentinel LNG enters the User Program.
2. Press the **[▶]** key until PROG is bracketed and press **[ENT]**.
3. Use the **[▲]** and **[▼]** keys to scroll to the desired Channel and press **[ENT]**.
4. Scroll to the Path submenu and press **[ENT]**.
5. Path Length and Axial Length appear with numeric values. To change a value, select the length type and press Enter.
6. Use the arrow keys to change the numbers and press Enter.

Press **[ESC]** to return to the PROG menu, or continue pressing **[ESC]** until the display screen reappears.

## 4.3 Entering Signal Parameters

In the Signal submenu, set parameters that affect the transducer signal:

**CAUTION!** The SIGNAL default settings are suitable for most applications. Consult the factory before changing any of these settings.

- |                  |                      |                         |                 |
|------------------|----------------------|-------------------------|-----------------|
| • Delta-T Offset | • Velocity Averaging | • Maximum Samples/Cycle | • Gain Mode     |
| • Zero Cutoff    | • Sample Size        | • Tx Bark Code          | • Delay Time    |
| • Peak Detection | • Batch Size         | • RxW Size              | • Active Tw Tbc |

While following the programming instructions, refer to Figure 231 on page 212.

**Note:** From the **PROG** menu, proceed directly to Step 4. To select a different option, scroll to that option and press **[ENT]** twice to select it (once to enter and again to confirm the selection).

To enter the Signal submenu:

1. Press **[ESC]**. The Sentinel LNG enters the User Program.
2. Press the **[▶]** key until PROG is bracketed and press **[ENT]**.
3. Use the **[▲]** and **[▼]** keys to scroll to the desired Channel and press **[ENT]**.
4. Scroll to the Signal option and press **[ENT]**.
5. The first prompt, Delta-T Offset, is the difference between the upstream and downstream transit times of the transducer signals. It should normally be set to 0. Press **[ENT]**, use the arrow keys to enter the new value, and press **[ENT]** to confirm the entry.

### 4.3 Entering Signal Parameters (cont.)

6. The next prompt requests the Zero Cutoff. Near “zero” flow, the Sentinel LNG may have fluctuating readings due to small offsets (caused by factors such as thermal drift in the fluid). The zero cutoff causes velocity measurements less than the cutoff to be reported as zero. To set the cutoff, press **[ENT]**, and use the arrow keys to enter the new value. Press **[ENT]** to confirm the entry.
7. The next prompt requests the Peak Detection method. In the “Peak” method, the peak is identified by testing a derivative of the signal. In the “Threshold” method, the peak is identified as the point where the signal crosses a threshold that is a percentage of the maximum signal detected. The peak method is more reliable in identifying the signal in dynamic conditions, while the threshold method is more reliable in marginal signal conditions.

**Note:** Do not change the peak detection method or values unless recommended by the factory.

- a. Press **[ENT]**. The screen shows the two display options, Peak and Threshold. Scroll to the desired option, and press **[ENT]**.
- b. The next screen depends on your selection in Step a.
  - Select Peak, and no further options are available. Press **[ESC]** to return to the Signal menu.
  - Select Threshold and press **[ENT]**, the screen shows three parameters: Min Threshold, Max Threshold and Percent of Peak. For each parameter, press **[ENT]**. Use the arrow keys to enter the new value, and press **[ENT]**.
8. The next prompt requests Velocity Averaging, in which users select a velocity measurement to smooth out noise in the signal. Press **[ENT]**, and use the arrow keys to change to the desired number. Press **[ENT]** to confirm the entry.
9. The next parameter is the Sample Size, the number of pulses each transducer (upstream and downstream) emits. It is set to 8 by default. Press **[ENT]**, and use the **[▲]** and **[▼]** keys to scroll to the new number (from 1 to 32). Press **[ENT]** to confirm the entry.
10. The next prompt requests Batch Size. Press **[ENT]** and use the **[▲]** and **[▼]** keys to scroll to the new number (from 1 to 32). Press **[ENT]** to confirm the entry.
11. The next parameter is the Max Samples/Cycle. Press **[ENT]** and use the **[▲]** and **[▼]** keys to scroll to the new number (32, 16 or 8). Press **[ENT]** to confirm the entry.
12. The next parameter is the Tx Bark Code. Press **[ENT]** and use the **[▲]** and **[▼]** keys to scroll to the new option (AUTO, OneBit, TwoBit, Fourbit, ElevenBit, or Pulse1Bit to Pulse16Bit). Press **[ENT]** to confirm the entry.
13. The next prompt is RxW Size. Press **[ENT]** and use the **[▲]** and **[▼]** keys to scroll to the new option (8192, 4096, 2048, 1024, 512, or 256). Press **[ENT]** to confirm the entry.
14. The next prompt is Gain Mode. Press **[ENT]** and use the **[▲]** and **[▼]** keys to scroll to AUTO or Manual. If you select AUTO and press **[ENT]** the screen returns to the Signal menu. If you select Manual, DAC Counts appears. Press **[ENT]**, use the arrow keys to enter the new value, and press **[ENT]**.
15. The next prompt is Delay Time. To change the delay time, press **[ENT]**, use the arrow keys to enter the new value, and press **[ENT]**.
16. The next prompt is ActiveTw Tbc. To change the numeric value, press **[ENT]**, use the arrow keys to enter the new value, and press **[ENT]**.

Entering parameters in the Signal option has been completed. Press **[ESC]** to return to the **PROG** menu, or continue pressing **[ESC]** until the display screen reappears.

### 4.4 Entering the Meter Correction (K) Factor

With the K Factor submenu, calibrate or adjust the Sentinel LNG readings to another flow reference. While following the programming instructions, refer to Figure 231 on page 212. To enter K Factor data:

**Note:** From the **PROG** menu, proceed directly to Step 4. To select a different option, scroll to that option and press **[ENT]** twice to select it (once to enter and again to confirm the selection).

1. Press **[ESC]**. The Sentinel LNG enters the User Program.
2. Press the **[▶]** key until **PROG** is bracketed in the top left corner and press **[ENT]**.
3. Use the **[▲]** and **[▼]** keys to scroll to the desired Channel and press **[ENT]**.
4. Scroll to the K Factor submenu and press **[ENT]**.
5. The screen shows three options: Off, Single and Table. Scroll to the desired option, and press **[ENT]**.
6. The menu varies, depending on the selection in Step 5.



- Select Off, and no further choices are available.
- Select Single, and the Sentinel LNG displays the K Factor. To change the value, press [ENT]. Use the arrow keys to change the value and press [ENT].

**IMPORTANT:** If the Reynolds Correction factor in the Fluid option has been enabled, the K factor should be set to 1.00. Otherwise, the typical factor is between 0.5 and 2.00.

- Select Table, and the screen displays four options: Units, Rows Used, Edit Table and Reset Table.
  - a. Select Units and press [ENT] and the screen displays the selected measurement units (either metric or English). Press [ESC] or [ENT] to return to the previous screen.
  - b. Select Rows Used and the program requests the number of rows desired. Enter the number (from 2 to 20) and press [ENT].
  - c. Select Edit Table and the table opens with a series of rows. Scroll to the desired row, and press [ENT].
  - d. For each row, the screen displays the X (velocity) value and the K Factor. To change either value, scroll to the value and press [ENT]. Use the arrow keys to change the value and press [ENT].
  - e. Repeat steps c and d until all available data (from 2 to 20 rows) has been programmed.
- Press [ESC] to return to the PROG menu, or continue pressing [ESC] until the display screen reappears.
  - a. Select Units and press [ENT] and the screen displays two more options: Velocity and Diagnostic. Select Velocity and press [ENT] and the screen displays Meters/sec. Press [ESC] or [ENT] to return to the previous screen. Select Diagnostic, press [ENT] and Reynolds # appears. Press [ESC] or [ENT] to return to the previous screen.
  - b. From the Unit Menu, select Rows Used and press [ENT]. Use the arrow keys to enter the desired number (from 2 to 20) and press [ENT].
  - c. Select Edit Table and press [ENT], and the table opens with a series of rows. Scroll to the desired row, and press [ENT].

## 4.4 Entering the Meter Correction (K) Factor (cont.)

- d. For each row, the screen displays the Reynolds Correction number (X) and the Kinematic Viscosity (K Fact). If you wish to change either value, scroll to the value and press **[ENT]**. Use the arrow keys to change the value (available in *Soundspeeds and Pipe Size Data*, document #914-004), and press **[ENT]**.
- e. Repeat steps c and d until all available data (from 2 to 20 rows) has been programmed.
- f. Press **[ESC]** to return to the **PROG** menu, or continue pressing **[ESC]** until the display screen reappears.
- g. To confirm changes to the table, from the Unit Menu, select Reset Table... and press Enter. To reset the table select Yes and press Enter. To not reset the table, select No and press Enter.

## 4.5 Entering Pipe Parameters

In the Pipe submenu, preprogrammed or special pipe parameters can be specified. While following the programming instructions, refer to Figure 231 on page 212. Remember to record all programmed data in Appendix C, *Data Records*.

**Note:** From the **PROG** menu, proceed directly to Step 4. If a different option is desired, scroll to that option, and press **[ENT]** twice to select it (once to enter and again to confirm the selection).

To access the Pipe submenu:

1. Press **[ESC]**. The Sentinel LNG enters the User Program.
2. Press the **[▶]** key until **PROG** is bracketed and press **[ENT]**.
3. Use the **[▲]** and **[▼]** keys to scroll to Composite and press **[ENT]**.
4. Scroll to the Pipe submenu and press **[ENT]**.

## 4.6 Entering the Pipe Material

1. The menu offers two options, Material and Lining. Be sure the Material option is highlighted, and press **[ENT]**.
2. Two other options now appear, Preprogrammed and Other. Scroll to the desired option, and press **[ENT]**.
3. The menu now varies with your choice in Step 2.
  - For preprogrammed materials, a list of materials opens. Table 2 below covers the available preprogrammed materials on the list. Press the **[▼]** or **[▲]** keys to scroll to the appropriate material. Press **[ENT]** to confirm the choice.
  - For other materials, the meter asks for the material Soundspeed. Press **[ENT]** to open the window. Then use the arrow keys to enter the known soundspeed, and press **[ENT]**.

**Table 2: Preprogrammed Pipe Materials**

Category	Specific Material	Category	Specific Material
Al - Aluminum	Rolled or None	Monel	None
Brass	None	Nickel	None
Cu - Copper	Annealed, Rolled or None	Plastic	Nylon, Polyethylene, Polypropylene, PVC (CPVC), or Acrylic
CuNi - Copper/Nickel	70% Cu 30% Ni or 90% Cu 10% Ni	Steel	Carbon Steel, Mild or Stainless Steel
Glass	Pyrex, Flint, or Crown	Tin	Rolled
Gold	Hard-drawn	Titanium	None
Inconel	None	Tungsten	Annealed, Carbide, Drawn
Iron	Armco, Ductile, Cast, Electrolytic	Zinc	Rolled

4. The next required parameter is either the outside diameter (OD) or the circumference (OD x Pi). Scroll to the measured parameter and press **[ENT]**. For either measurement, enter the desired value and press **[ENT]**.
 

**Note:** Obtain the required information by measuring either the pipe outside diameter (OD) or circumference at the transducer installation site. The data may also be obtained from standard pipe size tables found in Soundspeeds and Pipe Size Data (914-004).
5. The meter also requires the Wall Thickness (WT). Scroll to the WT option, and press **[ENT]**. Use the arrow keys to enter the known thickness, and press **[ENT]**.
 

**Note:** To obtain an accurate pipe wall thickness measurement, use an ultrasonic thickness gauge.
6. If certain materials (such as carbon or stainless steel, cast iron, PVC and CPVC) have been selected, the Sentinel LNG offers the option of entering the pipe dimensions by a standardized schedule. (This option does not appear unless one of these materials has been selected; if so, proceed to step **a** below.) Once the nominal pipe size and schedule number are entered, the Sentinel LNG determines the OD and wall thickness from an internal table.
  - a. Scroll to the Schedule option, and press **[ENT]**. A list of pipe sizes opens, from 15 to 200 mm (0.5 to 8 in.).
  - b. Scroll to the desired pipe size, and press **[ENT]**. A list of schedules opens.
  - c. Scroll to the desired schedule, and press **[ENT]**.

Entering the pipe parameters is complete. Press **[ESC]** to return to the Pipe Material/Lining window, or continue pressing **[ESC]** to return to the data display window.

## 4.7 Entering Pipe Lining Data

To access the Lining option:

1. From the Pipe submenu, scroll to the Lining option, and press **[ENT]**.
2. Two options appear, Material and Thickness. Be sure Material is highlighted, and press **[ENT]**.
3. Two other options now appear, Preprogrammed and Other. Scroll to the desired option, and press **[ENT]**.
4. The menu now varies with your choice in Step 3.

- For preprogrammed linings, the screen shows a list of Lining Materials, listed in Table 2-2 below. Scroll to the appropriate material. If the pipe has no lining, select “None.” Press **[ENT]** to confirm the choice.
- For other materials, the next screen asks for the lining Soundspeed. Press **[ENT]** to open the soundspeed window. Use the arrow keys to enter the known soundspeed, and press **[ENT]**.

**Table 3: Preprogrammed Lining Materials**

Lining Material Options	
None	Mortar
Tar/Epoxy	Rubber
Glass (Pyrex)	PTFE
Asbestos Cement	

**Note:** *If your pipe lining is not on the drop-down list, consult the factory for further information.*

Entering data in the Pipe submenu is complete. Now, do one of the following:

- To program in other options, press **[ESC]** to return to the **PROG** menu.
- To program in other menus, refer to Appendix A, *Menu Maps*, to navigate to the desired menu.
- To leave the User Program, press **[ESC]** until the display screen reappears.

## Chapter 5. Using PanaView

### 5.1 Introduction

This chapter provides comprehensive instructions for programming the data required to place the Sentinel LNG system into operation. In order to program the Sentinel LNG, the user must have a personal computer connected to the meter, and the PanaView™ software, shipped with the unit, installed on that computer.

**Note:** See the PanaView™ Graphical User Interface User's Manual for information on those User Program features not covered in this chapter. The Sentinel LNG is designed to be programmed and operated with PanaView™ software only.

### 5.2 Wiring the RS232 Interface

The Sentinel LNG uses an RS232 interface to communicate with a PC. For details on wiring your RS232 interface, please refer to Chapter 2 (*Installation*) of this manual and to the document *EIA-RS Serial Communications (916-054)*.

### 5.3 Establishing Communications with Panaview™

After your hardware and software have been installed as described in Chapter 2 of this manual and in Chapters 2 (*Installation*) and 3 (*Initial Setup*) of the PanaView™ User's Manual, the procedure for establishing communications with a meter may be started.

#### 5.3.1 Adding a Communications Port

Under File open a New Meter Browser. The browser is designed to access computers and instruments with the look and feel of a file management system. To connect to the instrument using a remote computer, first add that computer to your network. If the computer is connected directly to the instruments, add the communication ports to the browser network.

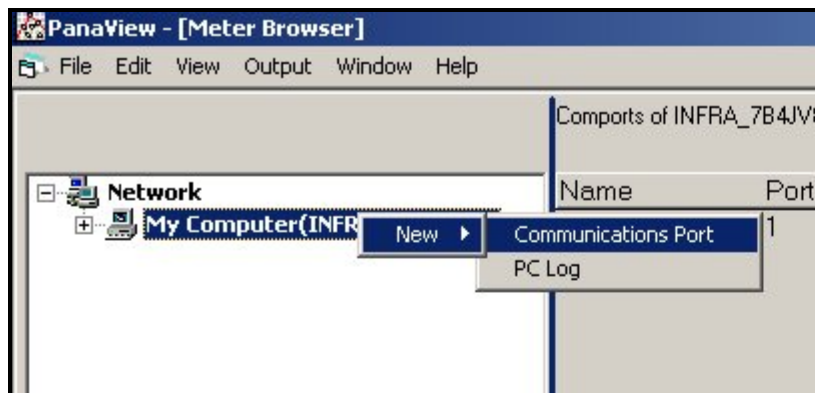

Figure 36: Adding a New Communication Port to the PC

Place the mouse pointer over the name of the computer and press the right mouse button. This activates the selection menu for this object (see Figure 36 above).

Select My Computer > New > Communications Port > and add a port by pressing the left mouse button.

### 5.3.1 Adding a Communications Port (cont.)

Once the port is added, the port properties will need to be set. See Figure 37 below which shows the default properties for the meter. The communication settings can be modified at any time by selecting the port on the network tree with the right mouse button and choosing Properties.

**Note:** Refer to *Adding a New Communication Port in Chapter 4 of the PanaView™ Instrument Interface Software Operation and Installation Guide (910-211C)*.

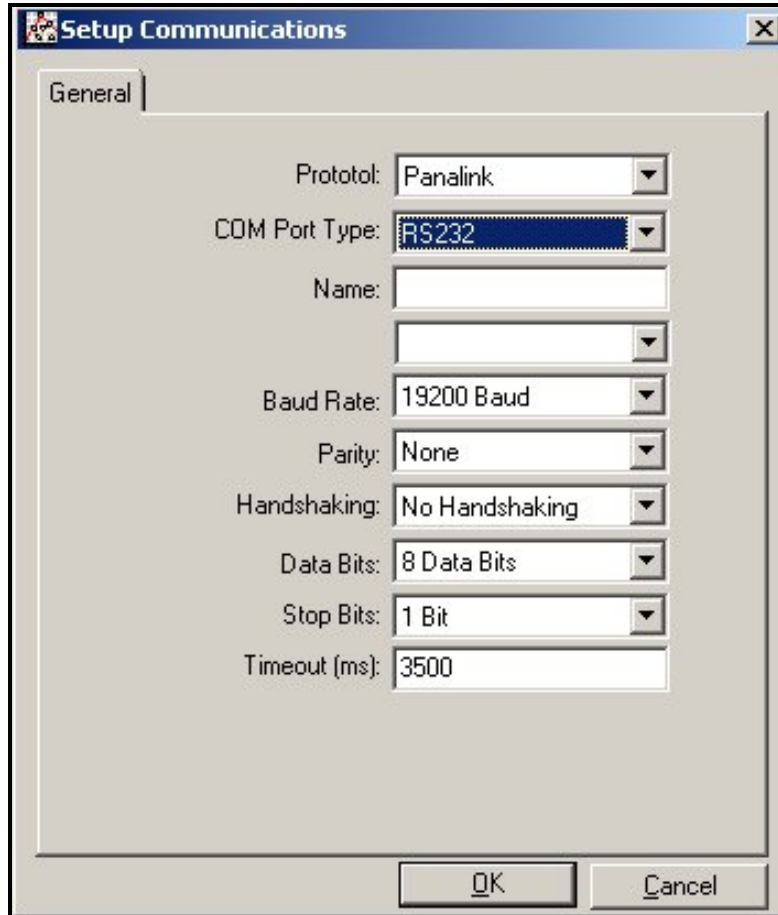

Figure 37: Default Communication Parameters

### 5.3.2 Adding the Sentinel LNG to the Communications Port

Select the desired communication port by clicking once on it with the left mouse button (see Figure 38 below). Then press the right mouse button to activate the pop-up menu. Select New > Meter > from the pop-up menu.

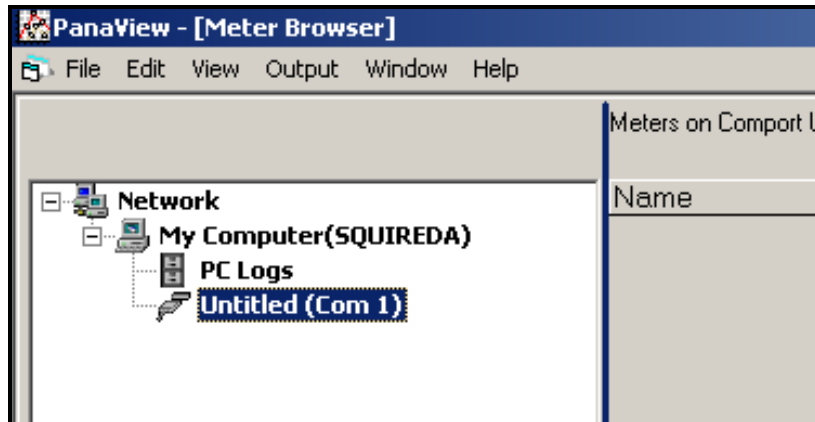

Figure 38: Adding the Sentinel LNG to the Comm Port

If the node ID is known, select “I know the node ID of the meter I am adding to the network,” then click the OK button (see Figure 39 below). If the node ID is not known proceed to page 69)

**Note:** The default node ID is 2. If another node ID was previously programmed, that data must be available in order to select “I know the node ID of the meter I am adding to the network.”

**Note:** The network referred to in Figure 39 below is the network of meters under a single communication port. Up to sixteen meters can be connected to form a PanaView™ meter network.

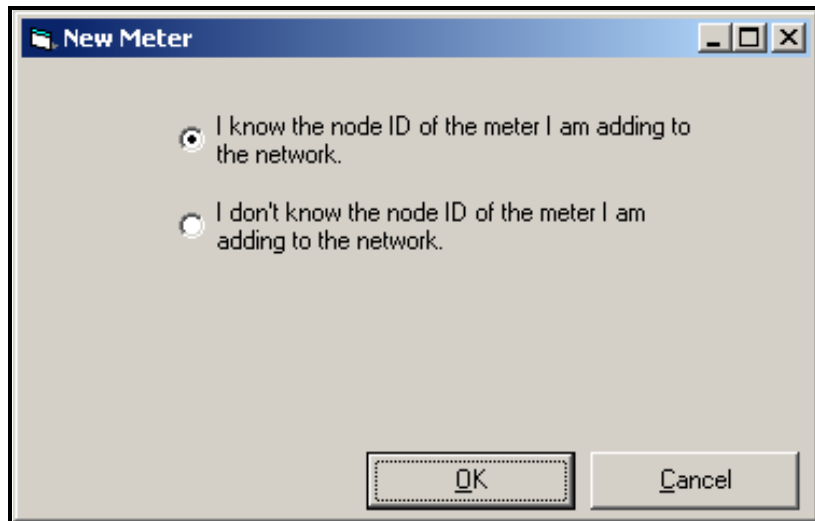

Figure 39: Instrument Node ID Acknowledgement

### 5.3.2 Adding the Sentinel LNG to the Communications Port (cont.)

Enter the ID number in the ID: entry, a meter name in the Name: entry, and then click on the OK button.

**Note:** Do not enter any data in the Clock: entry.

The screenshot shows the 'Add Meter - COM1' dialog box. It has a title bar with a close button. The main area is divided into several sections:

- General Information:** Name: New Meter, Model Name: ?????, Serial #: (empty), Firmware Version: ????, Up Time: (empty), PCI Order Number: ?????, Clock: (empty). Below these are 'Set' and 'Sync to PC' buttons.
- Node ID:** ID: 16, with 'Set Node ID' and 'Get Node ID' buttons.
- Meter Communication Parameters:** Com Port: COM 1, Port Type: RS232, Baud Rate: 115200, Data Bits: 8, Parity: None, Stop Bits: 1.
- Buttons:** OK and Cancel buttons at the bottom right.

Figure 40: Setting the Node ID



### 5.3.2 Adding the Sentinel LNG to the Communications Port (cont.)

If the node ID is not known, select "I don't know the node ID of the meter I am adding to the network" and then click on the OK button (see Figure 41 below).

**Note:** The network referred to in Figure 41 below is the network over which the new meter and the computer are communicating.

**Note:** The new meter must be the only powered meter on the network.

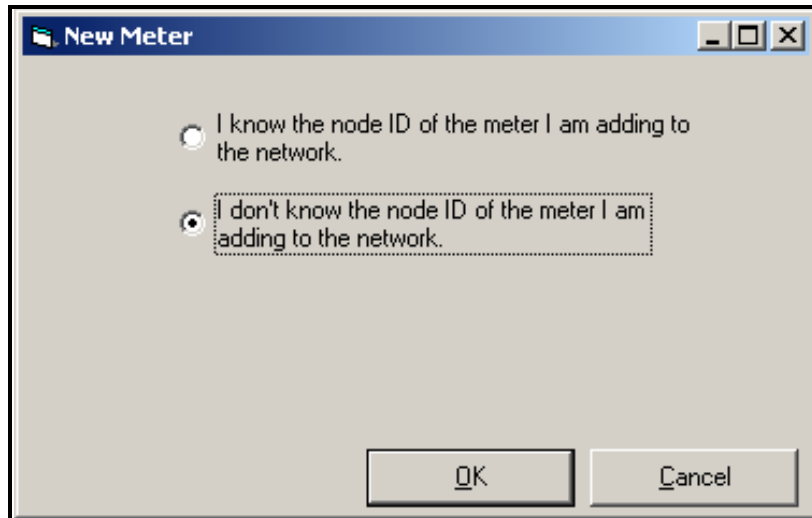

Figure 41: Instrument Node ID Disacknowledgement

At the next prompt (see Figure 42 below) select "It is the only meter connected to the communication port" and then click on OK.

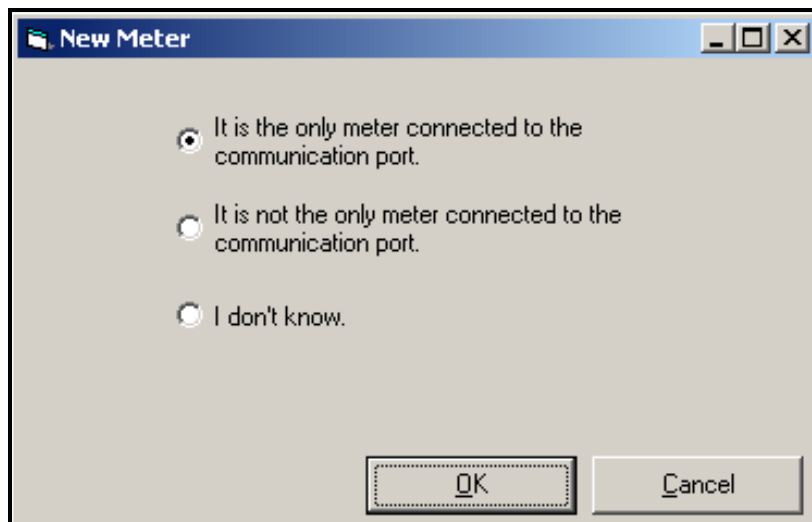

Figure 42: Searching the Port for Instrument Node ID

### 5.3.2 Adding the Sentinel LNG to the Communications Port (cont.)

If *PanaView*™ found the meter, a window will pop up and inform the user which Node ID the meter is set to. The operator can select to use the existing Node ID or a different Node ID (see Figure 43 below).

**Note:** *The Node ID can be changed later on by going to the meter properties.*

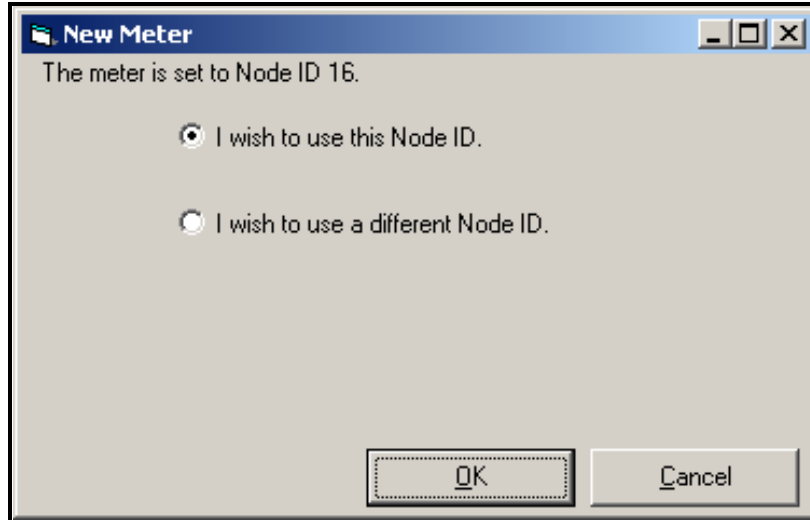

Figure 43: Selecting the Node ID

Once communication has been established, the Node ID can be set to any "master" Node ID. A "master" Node ID is an integer which is a multiple of 16.

**Note:** *A "slave" Node ID is all the numbers between two consecutive masters. However the term "slave" does not apply to the Sentinel LNG.*

If "I wish to use a different Node ID" is selected, the window in Figure 40 on page 68 appears, and the user must then enter the Node ID number in the ID entry.

Once the Node ID is entered in the Add Meter window ID box, click on the OK button to add the meter to the *PanaView*™ network.

## 5.4 Meter Security

After the node address is set, the instrument will be added to the network of instruments on *PanaView™* and the operator will be given the opportunity to program the flowmeter parameters. Before any meter parameters can be changed, the operator must be specified.

Each property menu window includes a SECURITY button which enables the user to set security for individual meter parameters. From a property menu window, press the SECURITY button and the following screen appears. To restrict other people from changing parameters, enter a passcode in the four single-digit windows, press Enter to accept the passcode and press Lock Out to set security. To change a parameter, the passcode must be entered.



The Security Form dialog box has a title bar that says "Security Form". Below the title bar is the text "Enter Passcode". There are four input boxes, each containing the digit "0". Below the input boxes are two buttons: "Cancel" and "Enter". At the bottom of the dialog is a larger button labeled "Lock Out".

Figure 44: Security Form

## 5.5 Meter Properties

1. To set meter properties, click twice on the meter name and a list of parameter menus appears.

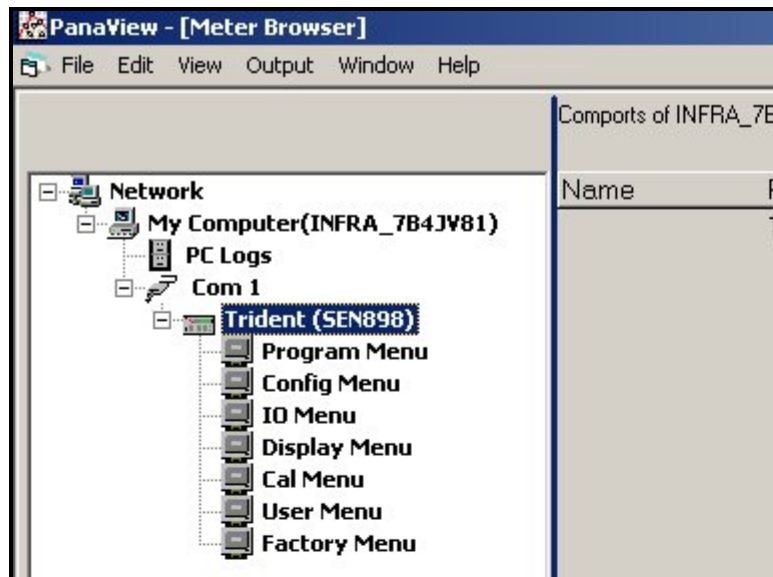

Figure 45: Parameter Menus

## 5.6 Program Menu

1. To set up a channel, click twice on Program Menu and the following screen appears.

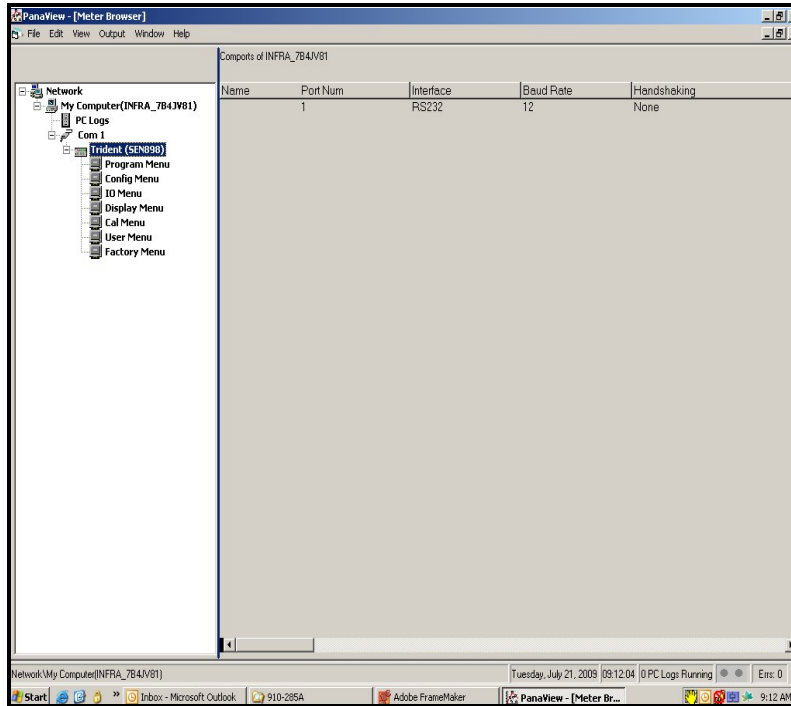

Figure 46: Program Channels

2. Click twice on the appropriate Channel # and the following screen appears.

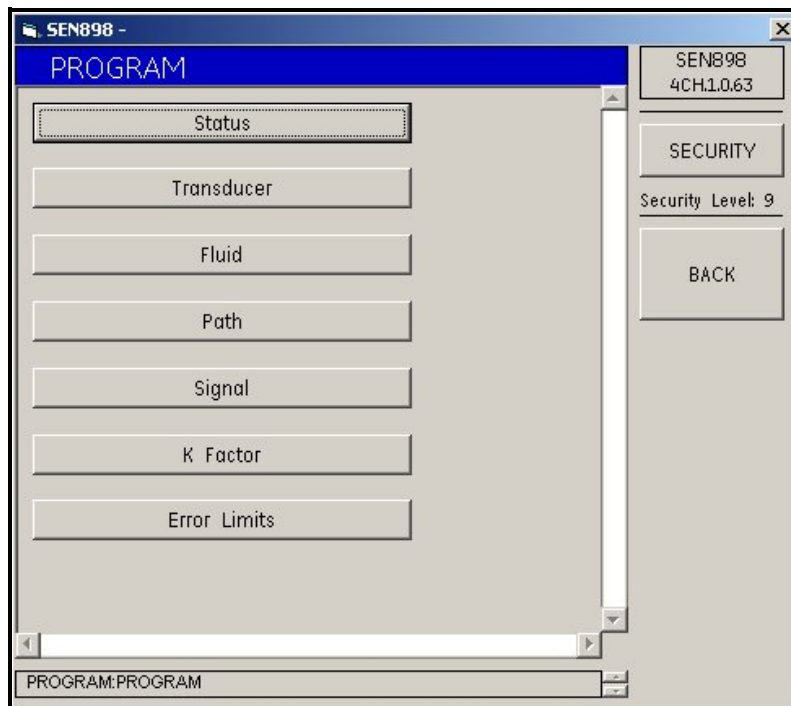

Figure 47: Meter Properties

### 5.6.1 Status Setup

1. To select whether the channel is on or off, click on Status and the following screen appears. Click On or Off twice, and the screen returns to the PROGRAM menu.

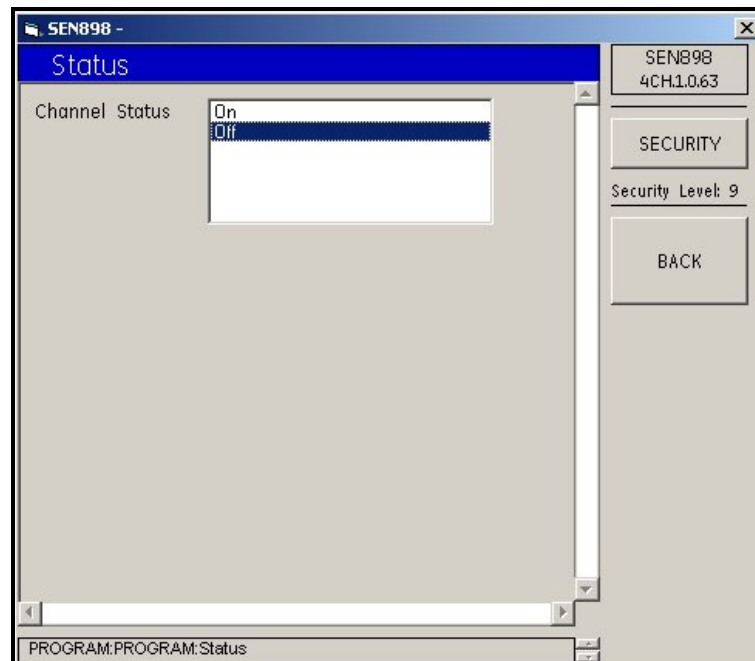

Figure 48: Channel Status

### 5.6.2 Transducer Setup

1. To select the transducer type, click on Transducer and the following screen appears.

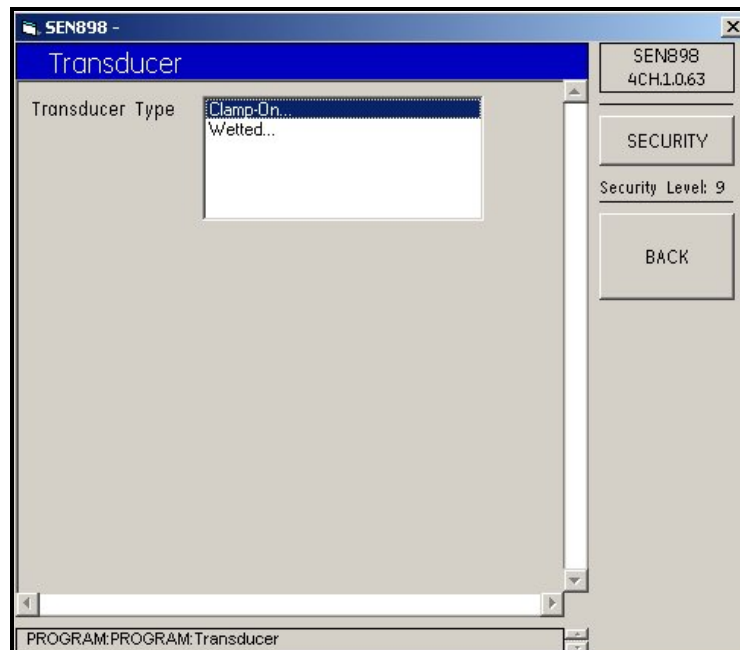

Figure 49: Transducer Types

## 5.6.2 Transducer Setup (cont.)

- Click twice on one option. If Clamp-On is selected, the following screen appears.

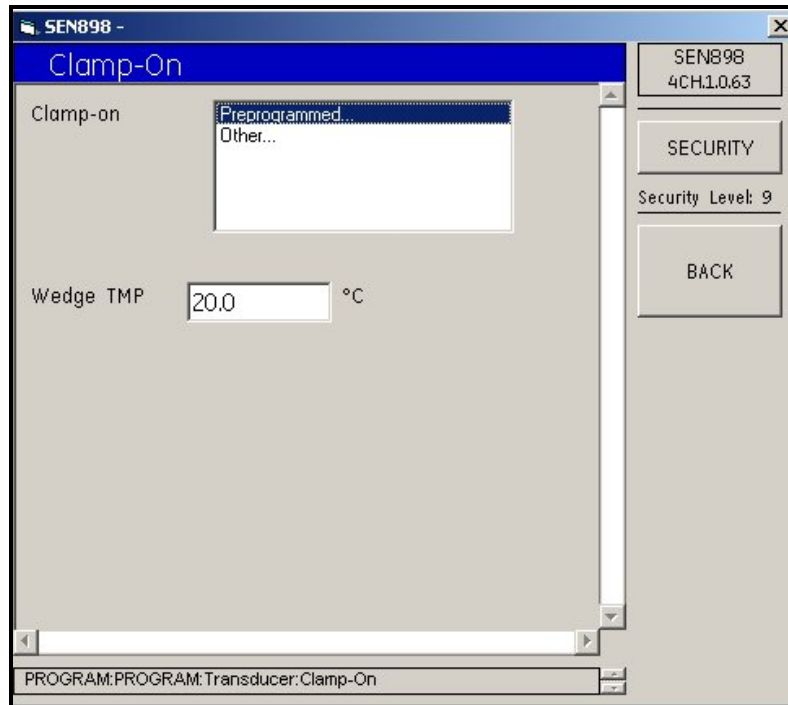

Figure 50: Clamp-On Transducer Options

- To change the wedge temperature, enter the appropriate numbers into the text box (the box turns yellow), and click on BACK. The Wedge TMP Verification screen appears. Click Yes to save the change, or No to return to the previous value.

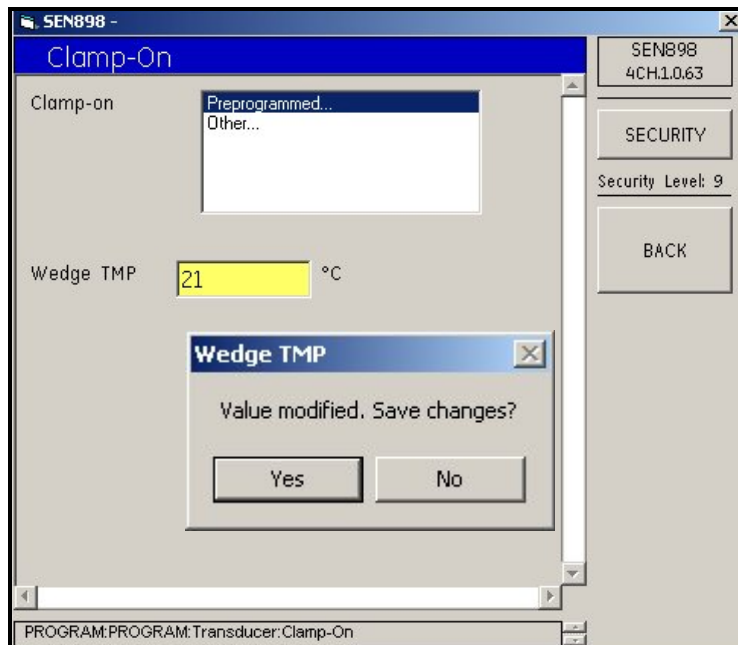

Figure 51: Wedge Temperature Verification

## 5.6.2 Transducer Setup (cont.)

- Click twice on Preprogrammed... or Other... If Preprogrammed is selected, the following screen appears.

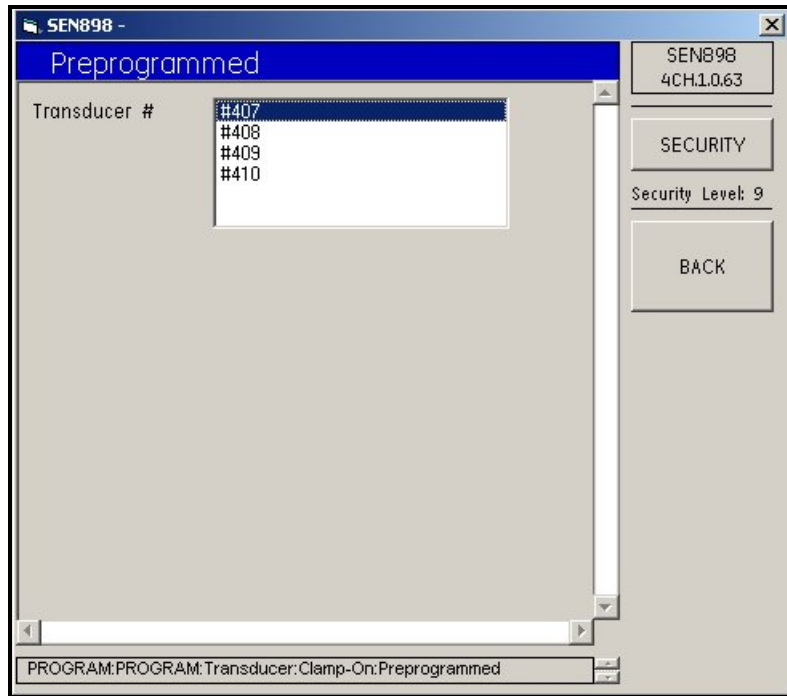

Figure 52: Preprogrammed Transducer Options

- Click twice on the appropriate transducer number and the screen returns to the Clamp On menu.
- If Other... is selected, the following screen appears.

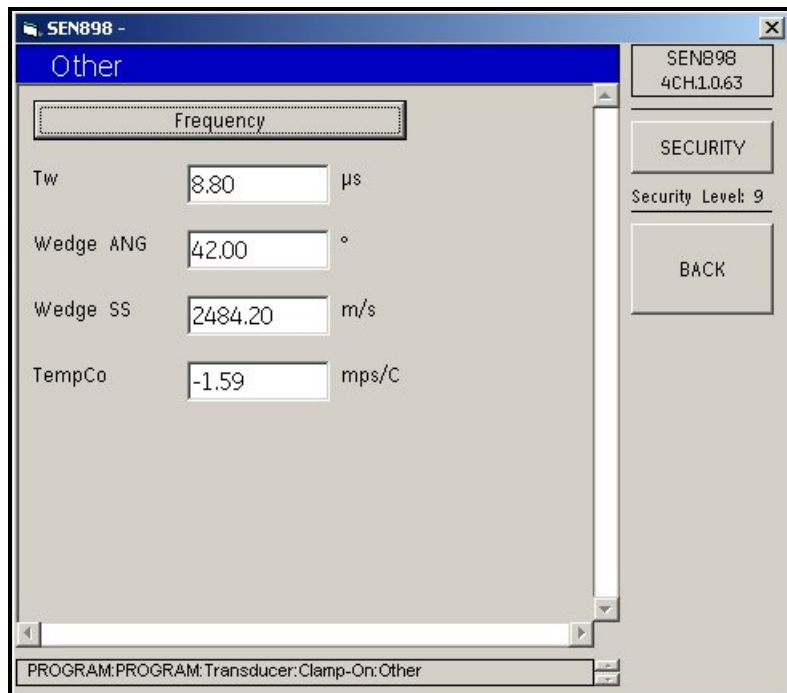

Figure 53: Other Transducer Menu

## 5.6.2 Transducer Setup (cont.)

- To change one or more of the transducer characteristics, enter the appropriate numbers into the text box (the box turns yellow), and click on BACK. The Verification screen appears. Click Yes to save the change, or No to return to the previous value.

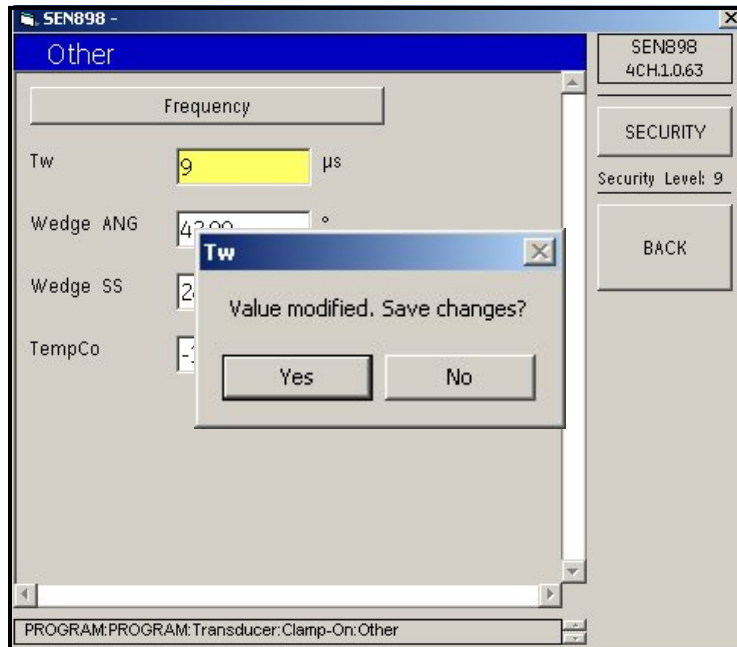

Figure 54: Tw Value Verification

- To select a frequency, click on Frequency, and the following screen appears.

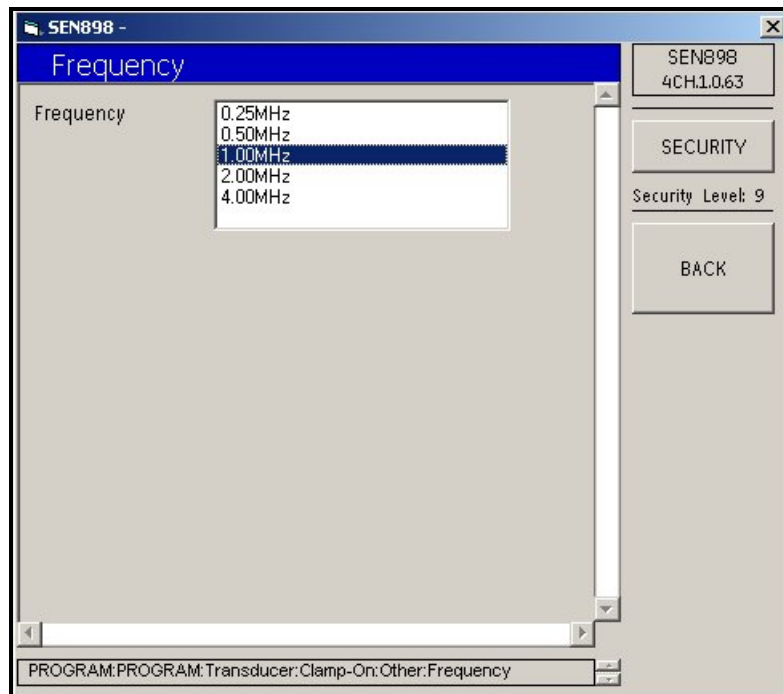

Figure 55: Transducer Frequency Options



## 5.6.2 Transducer Setup (cont.)

9. Click twice on the appropriate frequency and the screen returns to the previous menu. Click on the BACK button and return to the PROGRAM menu.

**Note:** If *Wetted* was selected under *Transducer Type* (see Figure 49 on page 73), the following screen appears.

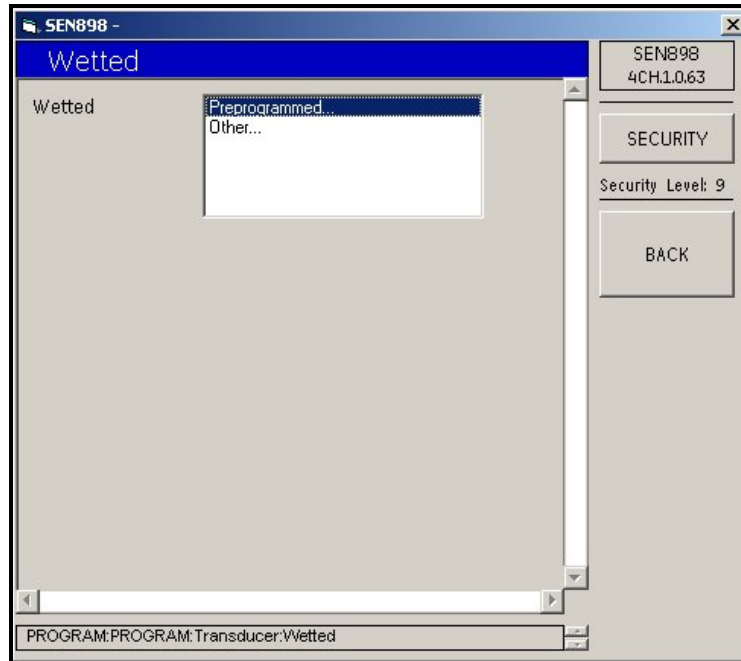

**Figure 56: Wetted Transducer Options**

10. Click twice on Preprogrammed... or Other... If Preprogrammed is selected, the following screen appears.

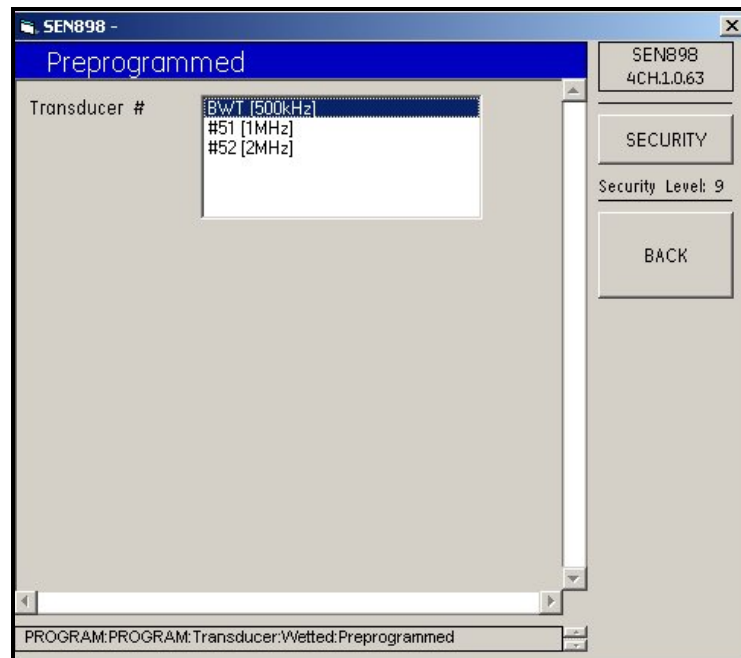

**Figure 57: Preprogrammed Transducer Options**

11. Click twice on the appropriate transducer number and the previous screen appears.

## 5.6.2 Transducer Setup (cont.)

12. If Other was selected under Wetted (see Figure 56 on page 77), the following screen appears.

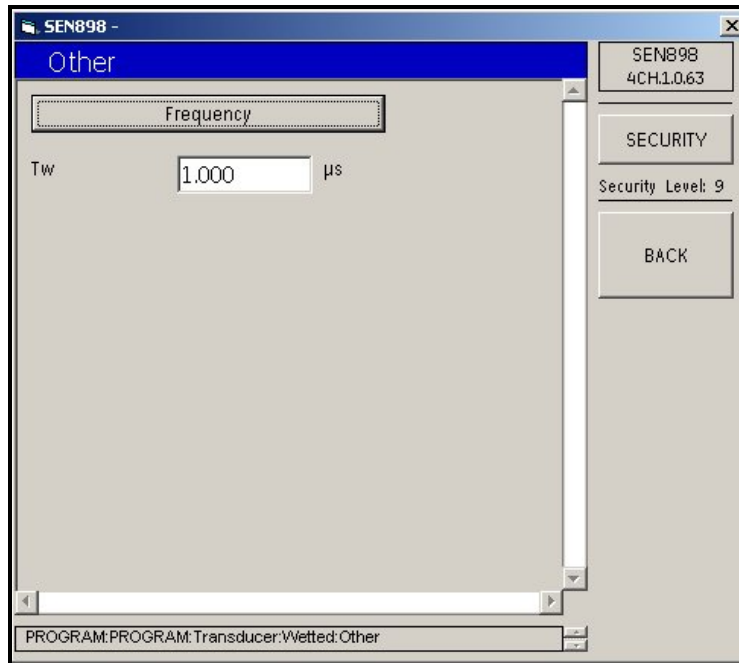

Figure 58: Other Transducer Menu

13. Click on Frequency and the following screen appears. Click twice on the appropriate value and the previous screen returns. If necessary, change the time value in the text box. Click on BACK to return to the Program Menu.

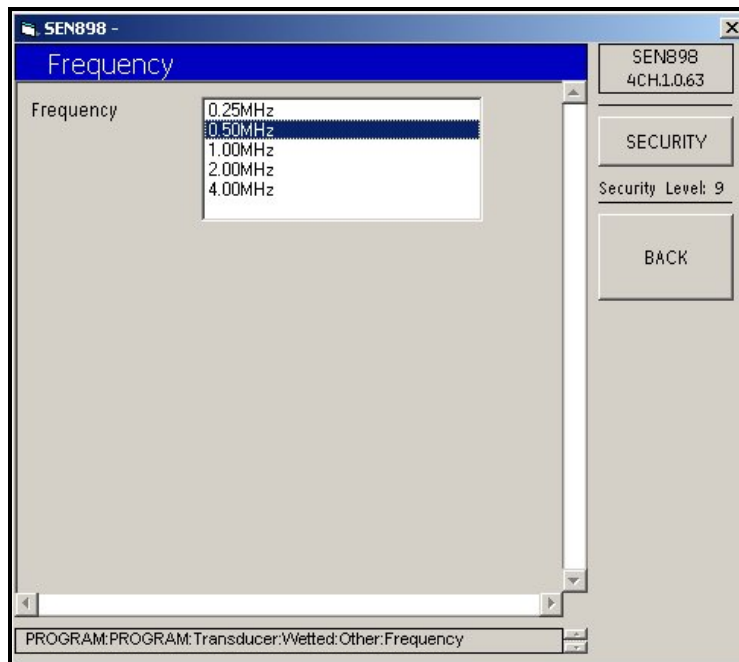
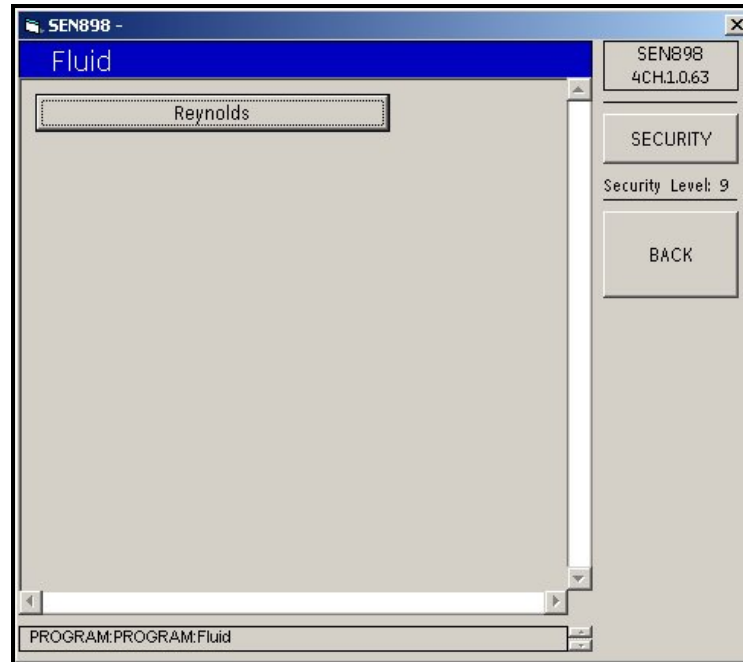

Figure 59: Frequency Options

## 5.6.3 Fluid Setup

1. From the Program Menu, click on Fluid. The following screen appears.



**Figure 60: Fluid Reynolds Correction**

2. To set up the Reynolds correction format, click on Reynolds and the following screen appears.

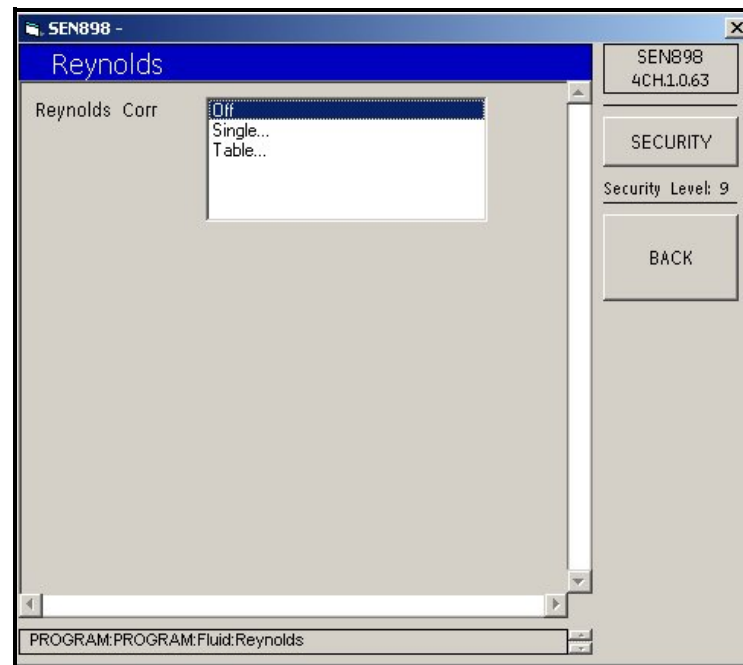

**Figure 61: Fluid Reynolds Correction Menu**

### 5.6.3 Fluid Setup (cont.)

- To turn off the Reynolds Correction Factor, click Off. Click Single... and the following screen appears.

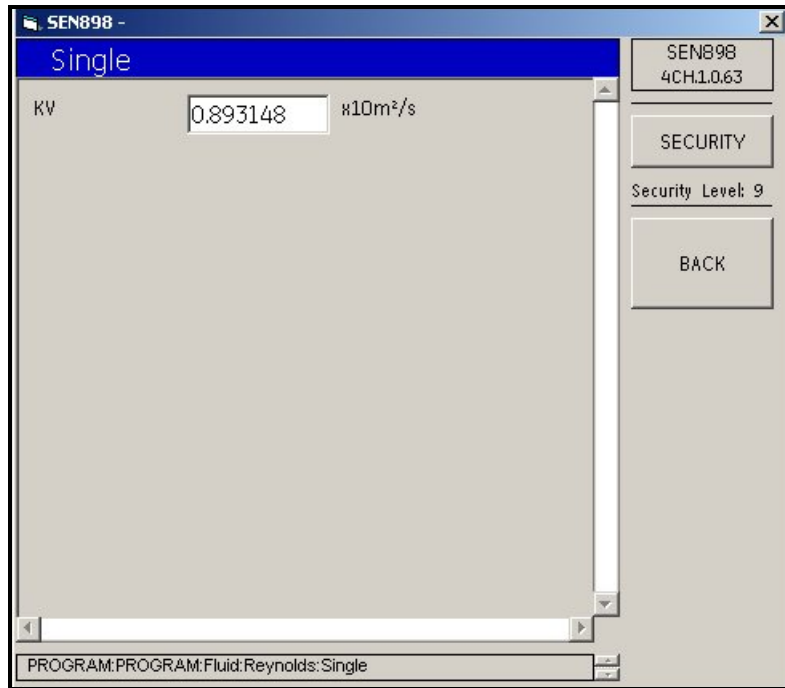

Figure 62: Reynolds Correction Single Option

- Enter the correct text box measurement and click BACK to return to the previous screen. If Table... was selected on the previous screen, the following screen appears.

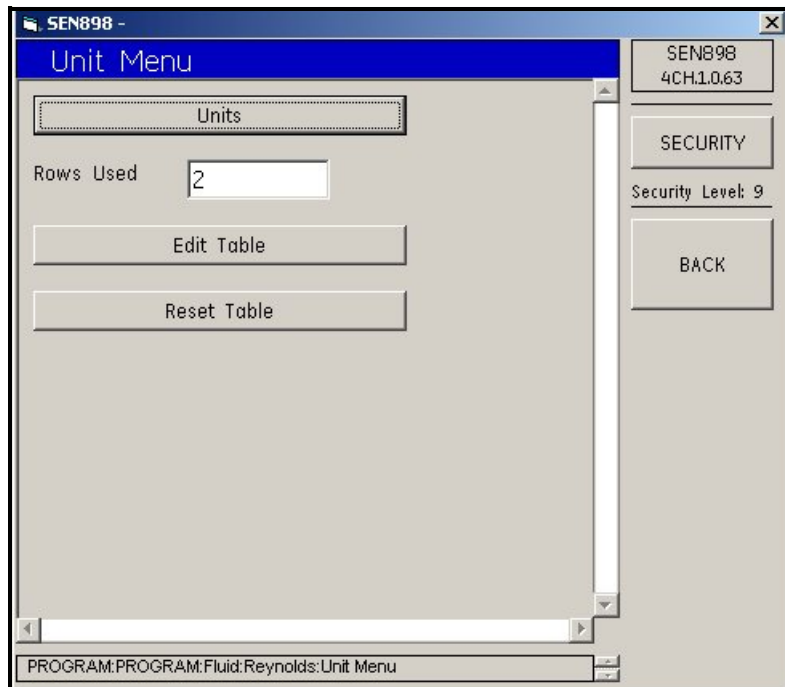
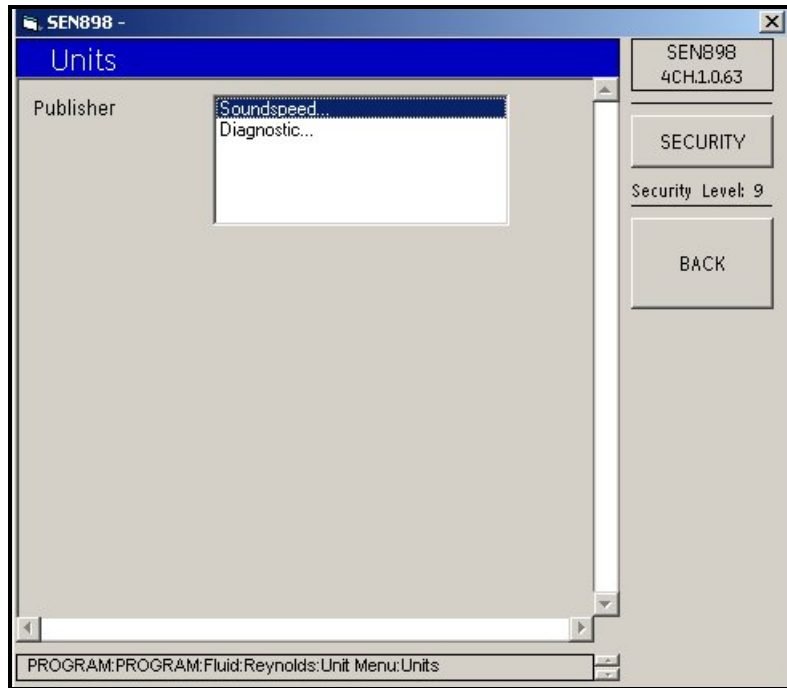

Figure 63: Reynolds Correction Unit Menu

### 5.6.3 Fluid Setup (cont.)

- Click on Units and the following screen appears.



**Figure 64: Reynolds Correction Units**

- Click twice on Soundspeed... and the unit option is Meters/sec. Click twice on Diagnostic... and the unit options are Signal Up or Signal Dn. Click on BACK to return to the Unit Menu.

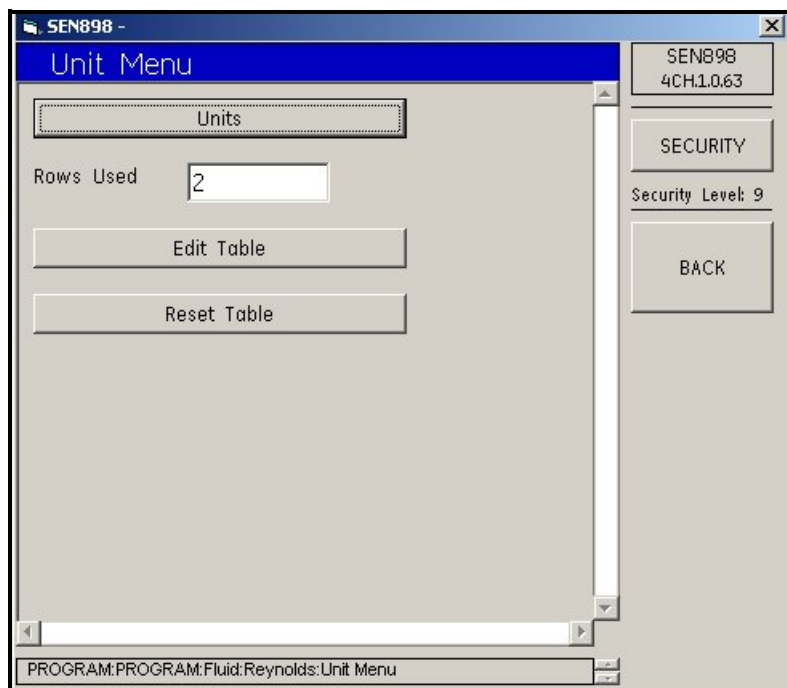

**Figure 65: Reynolds Correction Unit Menu**

### 5.6.3 Fluid Setup (cont.)

- Click on Edit Table and the following screen appears.

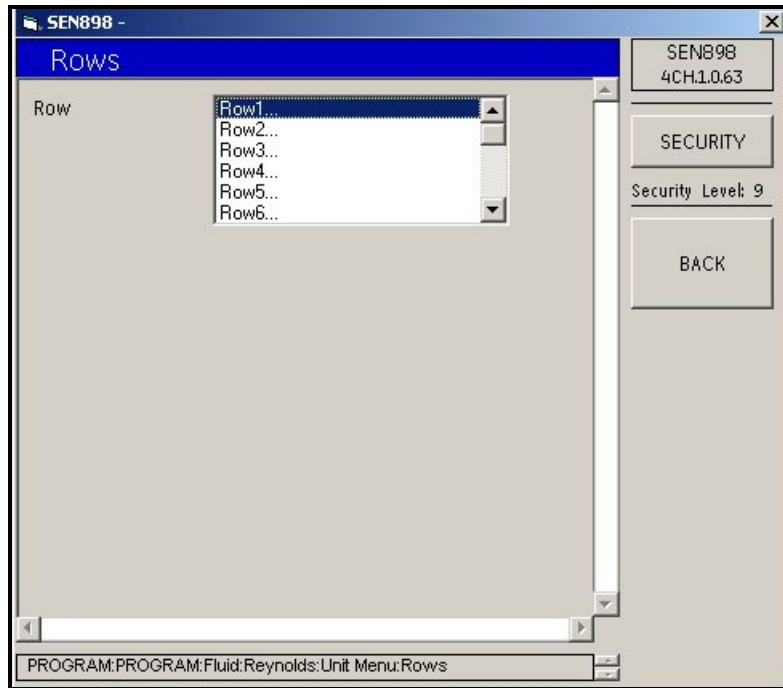

**Figure 66: Reynolds Correction Row Options**

- Click twice on the Row... to be changed and the following screen appears. Read the AutoFormsNumeric message, click OK, and enter the appropriate values in the text boxes above.

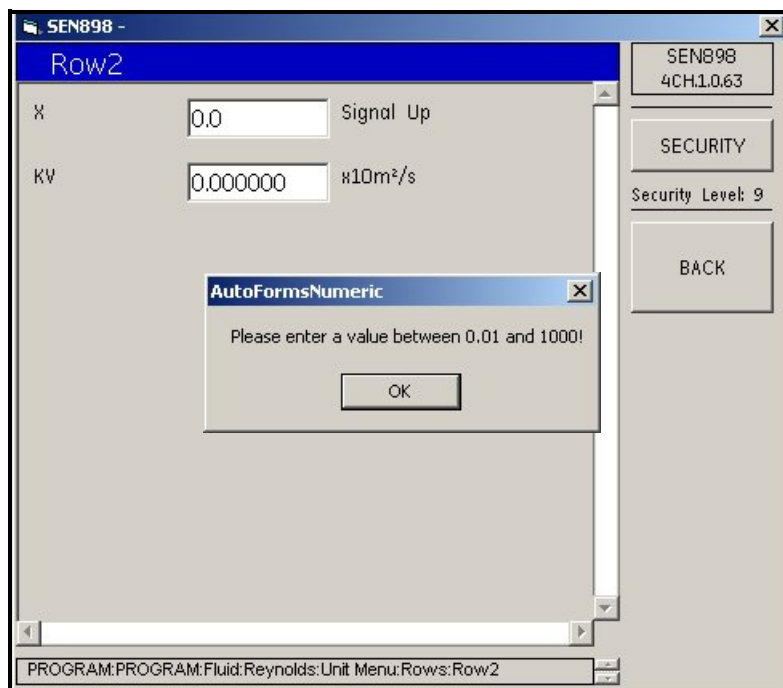

**Figure 67: Editing Row Values**

- Click on BACK twice to return to the Unit Menu and click on Reset Table to secure the value changes made above. The following screen appears.

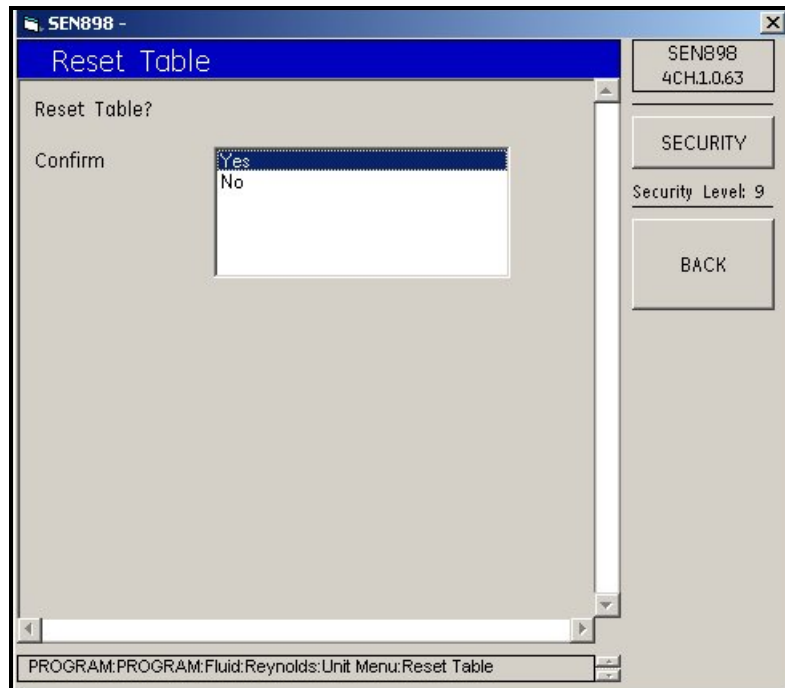
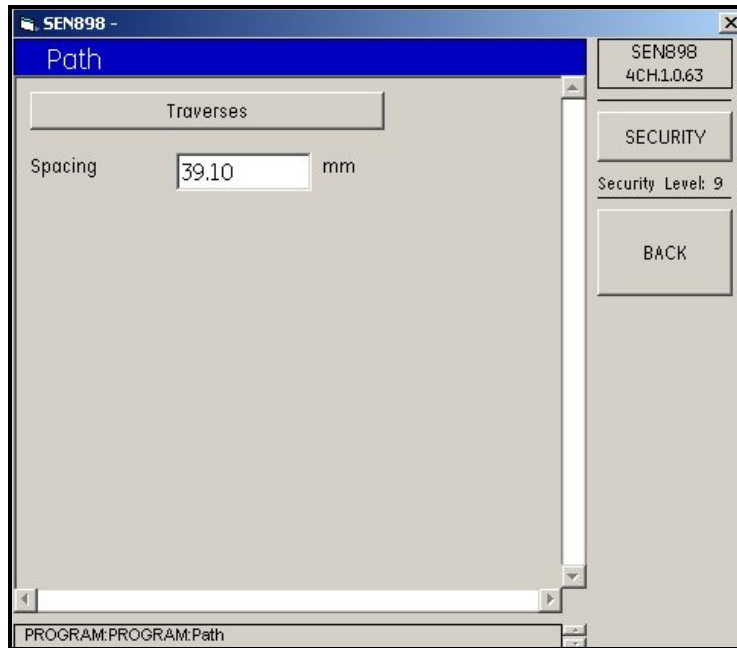

**Figure 68: Resetting the Table**

- Click twice on Yes to confirm the changes, and the screen returns to the Unit Menu. To enter more table values, repeat Steps 7 to 9. To program other parameters, click on BACK three times to return to the Program screen.

## 5.6.4 Path Setup

1. To change path data, click on Path and the following screen appears.



**Figure 69: Editing Path Data**

2. To edit the number of path traverses, click on Traverses, and the following screen appears. Click twice on the appropriate number, and the screen returns to the Path screen.

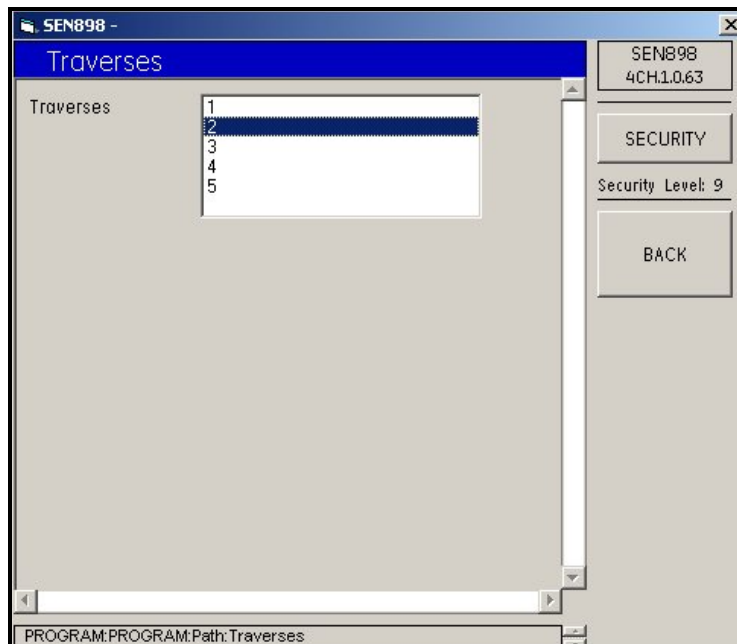

**Figure 70: Number of Traverses**

3. To change the path spacing, enter the number of millimeters into the text box and click on BACK. Click Yes on the Spacing Verification screen, and click on BACK. The screen returns to the Program menu.



### 5.6.5 Signal Setup

1. To set up or make changes to the signal values, click on Signal and the following screen appears.

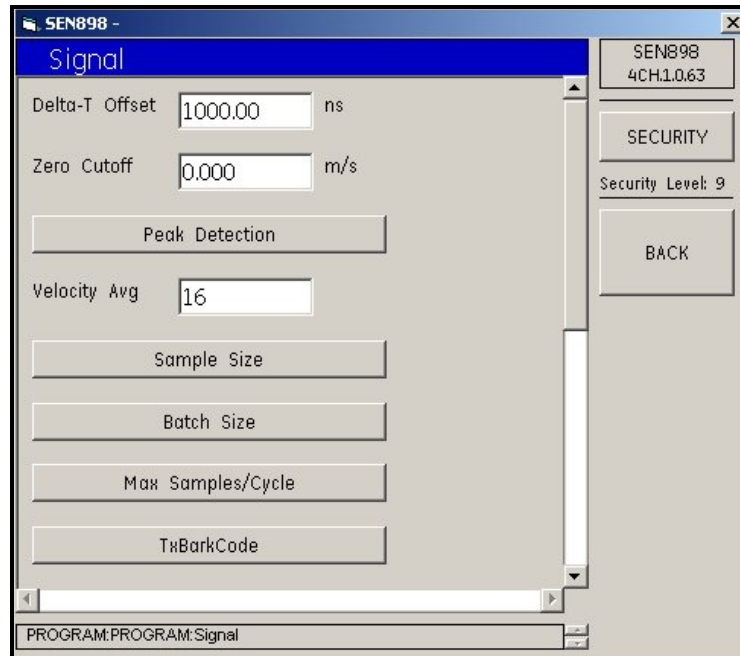

Figure 71: Editing Signal Values

2. Click on categories to be set, select a type from each list, and make changes to the text boxes as needed.

### 5.6.6 K Factor Setup

To set up the K Factor, from the Program screen, click on K Factor and proceed as in Fluid beginning on page 78.

### 5.6.7 Error Limits Setup

To set error limits, from the Program Menu, click on Error Limits and the following screen appears.

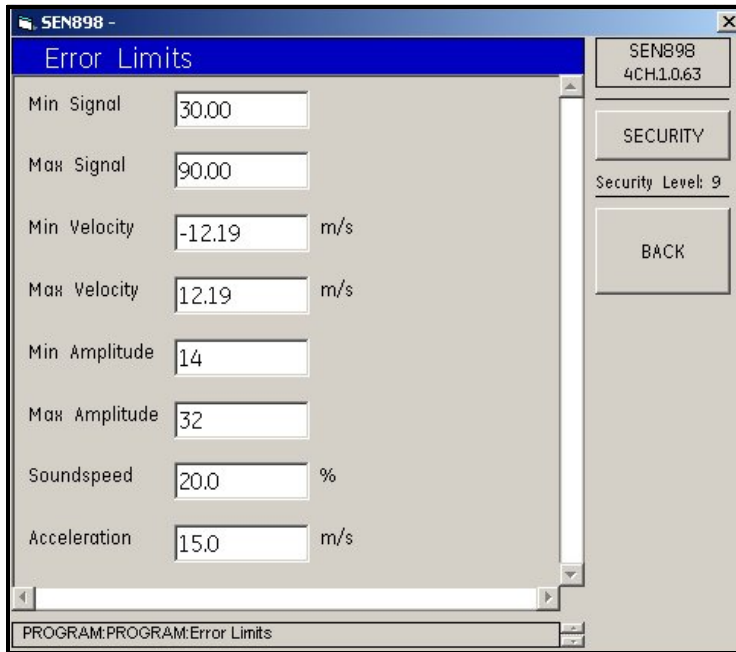

**Figure 72: Setting Error Limits**

Enter the appropriate values into the text boxes and click on BACK to return to the Program Menu.

## 5.7 Composite Programs

- From the PROGRAM menu, click twice on Composite, and the following screen appears.

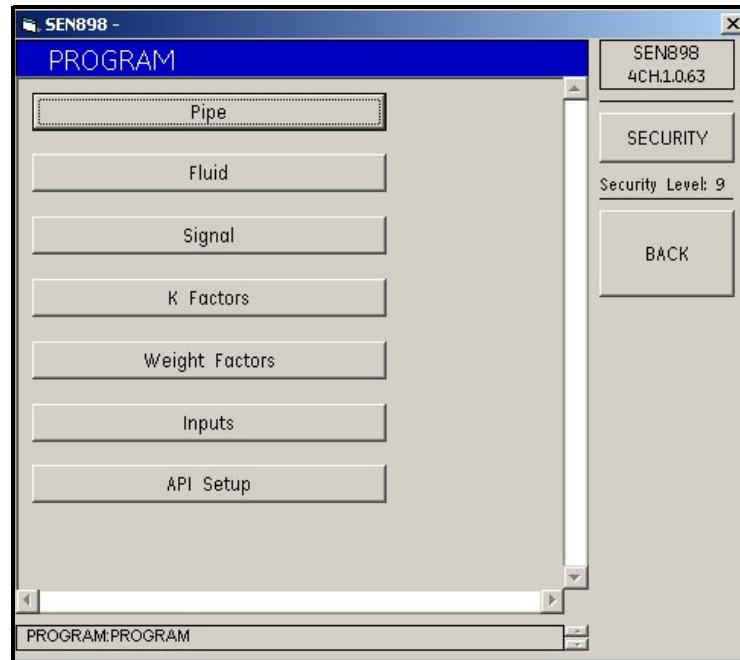

Figure 73: Composite Program Menu

### 5.7.1 Pipe Setup

- To enter pipe information, click on Pipe and the following screen appears.

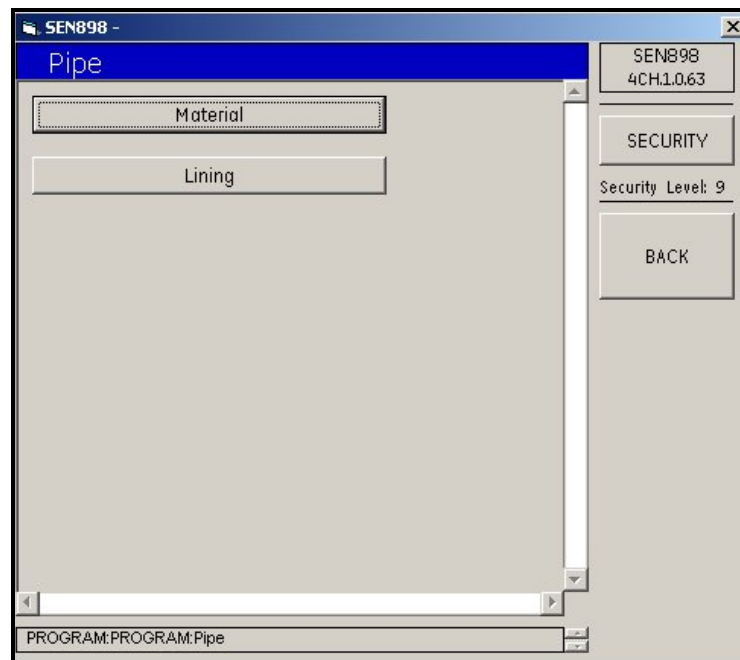

Figure 74: Pipe Information Menu

### 5.7.1 Pipe Setup (cont.)

2. Click on Material and the following screen appears.

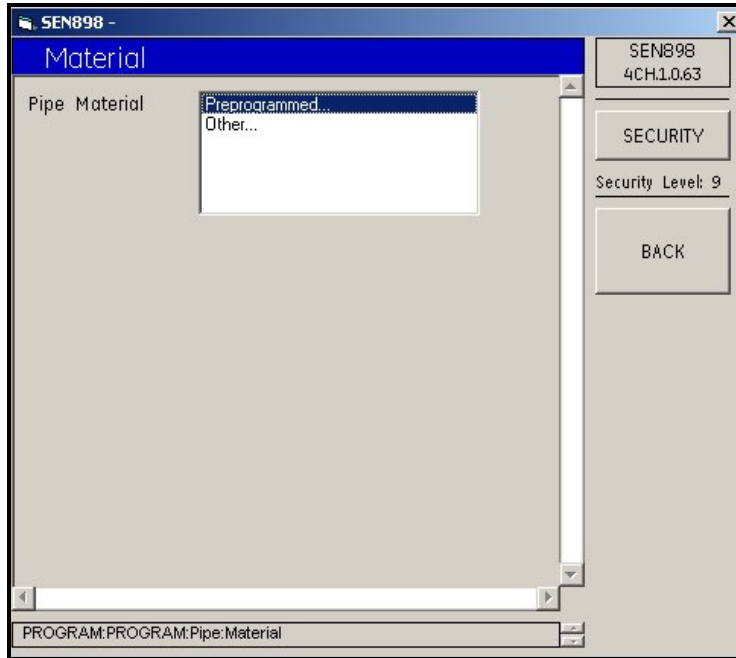

Figure 75: Pipe Material

3. If the pipe material is standard, click on Preprogrammed... and the following screen appears.

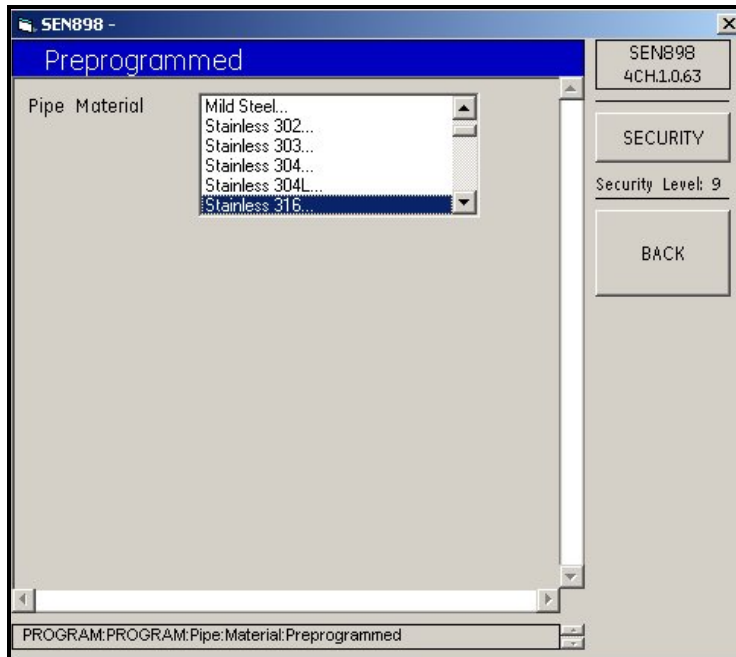
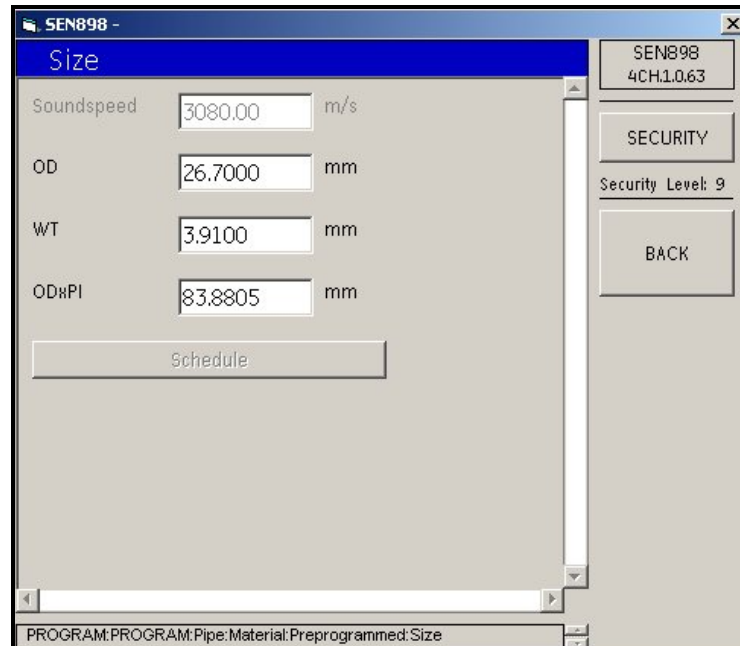

Figure 76: Preprogrammed Pipe Material

### 5.7.1 Pipe Setup (cont.)

4. Locate the type that matches the pipe, click on it twice, and the following screen appears.



**Figure 77: Preprogrammed Pipe Material**

5. Enter the pipe size into each text box according to the category listed. When finished, click three times on BACK to return to the Pipe Menu.
6. If the pipe material is not standard, from the Pipe Menu, click on Material, then click on Other... The following screen appears.

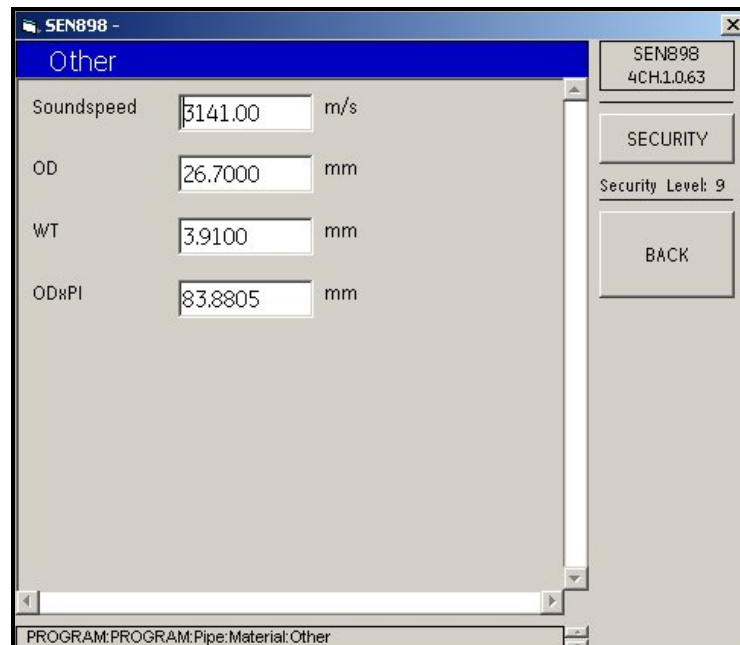

**Figure 78: Other Pipe Material**

### 5.7.1 Pipe Setup (cont.)

7. Enter the pipe size into each text box according to the category listed. When finished, click three times on BACK to return to the Pipe Menu.
8. To enter pipe lining characteristics, from the Pipe Menu click on Lining. The following screen appears.

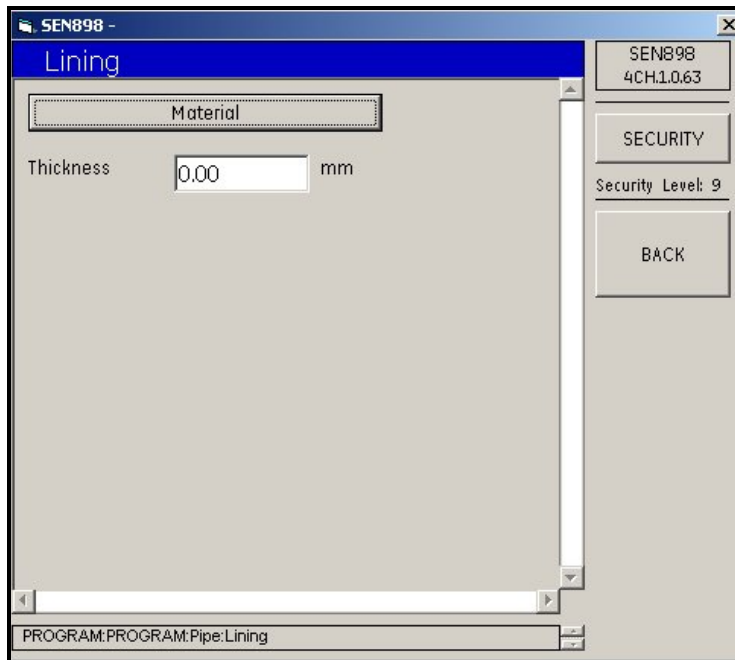

Figure 79: Lining Menu

9. Click on Material and the following screen appears.

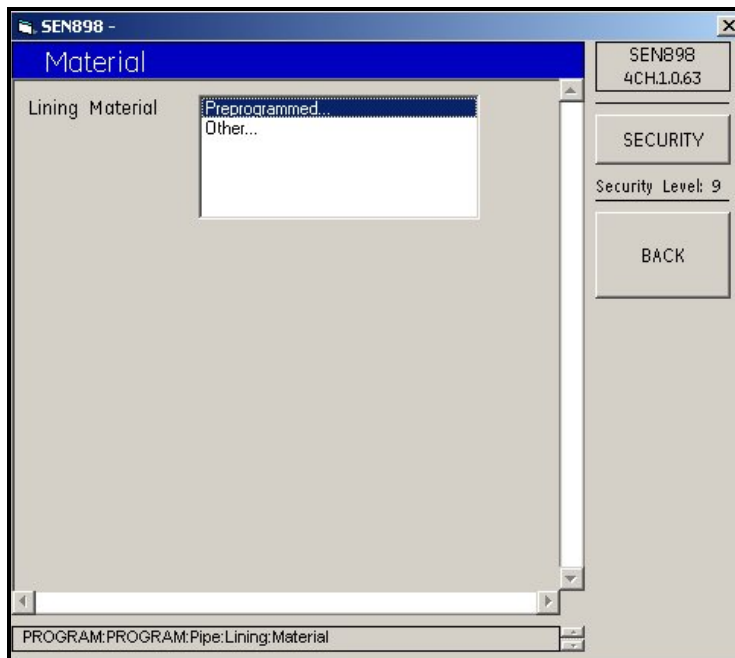

Figure 80: Lining Material Options

### 5.7.1 Pipe Setup (cont.)

10. If there is no pipe lining, or the pipe lining is standard material, click twice on Preprogrammed... The following screen appears.

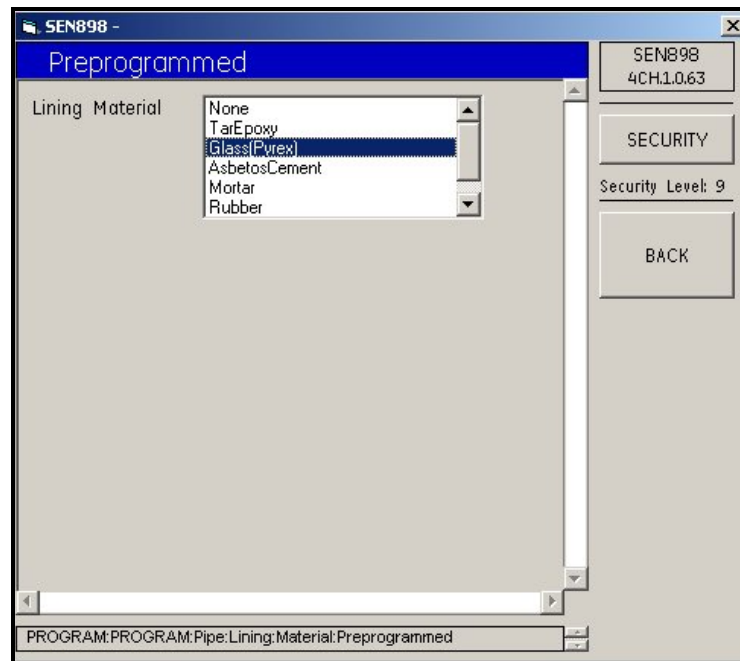

Figure 81: Lining Material Types

11. Click twice on the lining material and the screen returns to the previous menu.  
 12. If the lining is not standard, click twice on Other and the following screen appears.

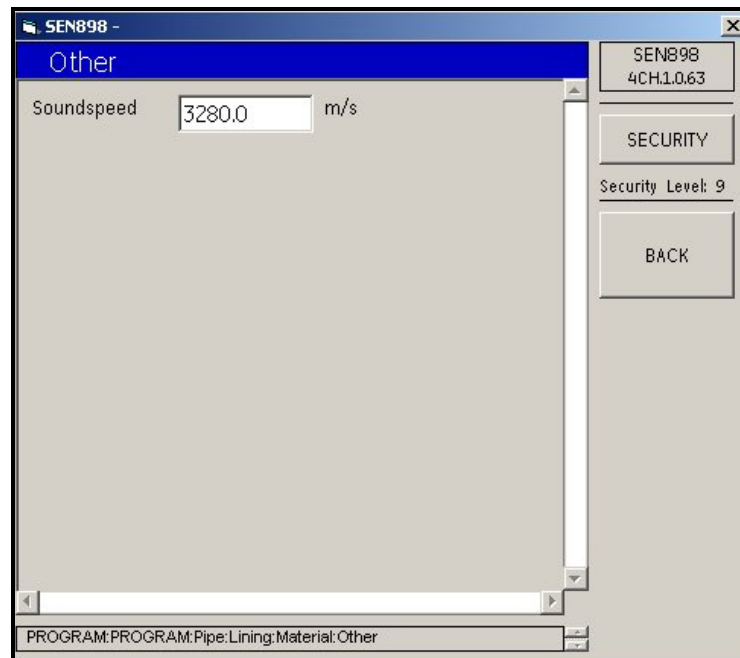

Figure 82: Other Lining Material Soundspeed

### 5.7.1 Pipe Setup (cont.)

13. Enter the Soundspeed of the lining material and click on BACK twice. The screen returns to the Lining Menu.
14. Whether the pipe lining is Preprogrammed... or Other..., the Lining Menu screen includes a text box labeled Thickness. Enter the lining material thickness in millimeters, click on BACK, and click Yes on the Thickness Verification screen.
15. The screen returns to normal mode as shown below. Click on BACK twice to return to the Program Menu.

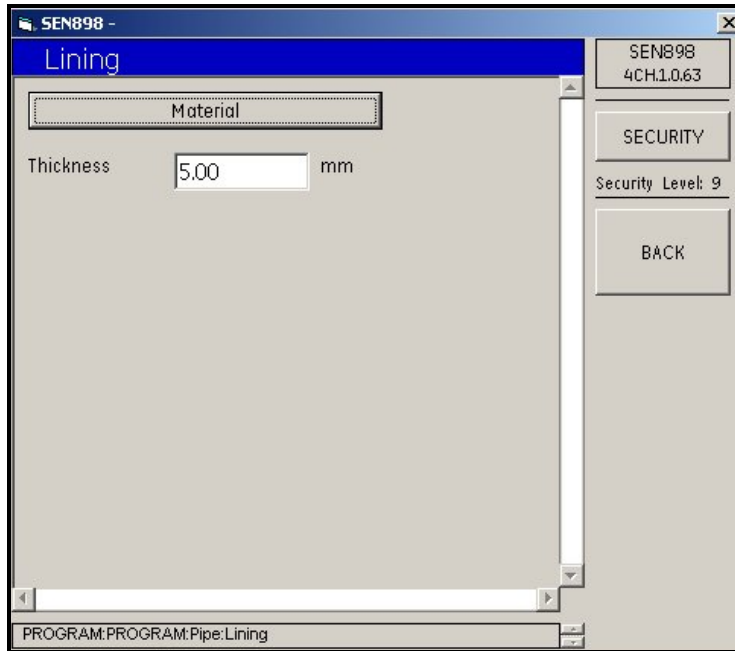

Figure 83: Lining Menu Complete



## 5.7.2 Fluid Setup

1. Click on Fluid and the following screen appears.

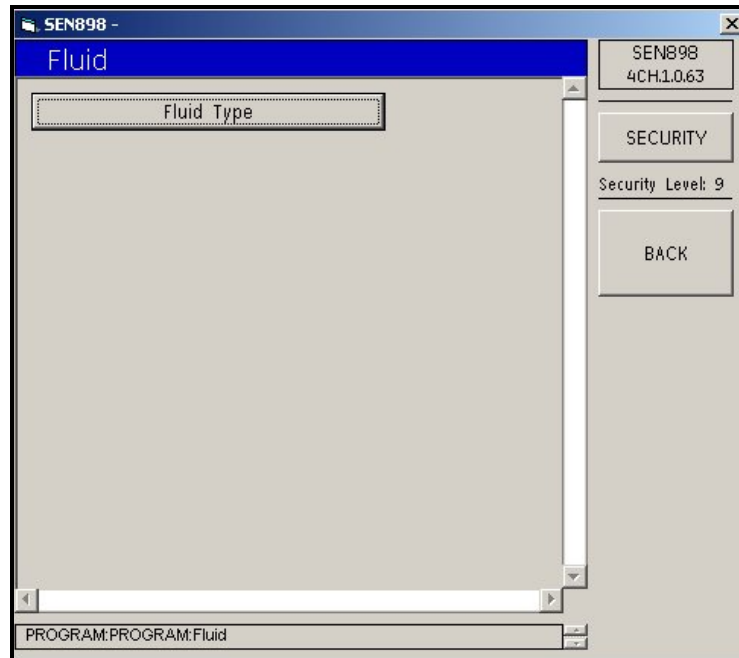

Figure 84: Fluid Menu

2. Click on Fluid Type and the following screen appears.

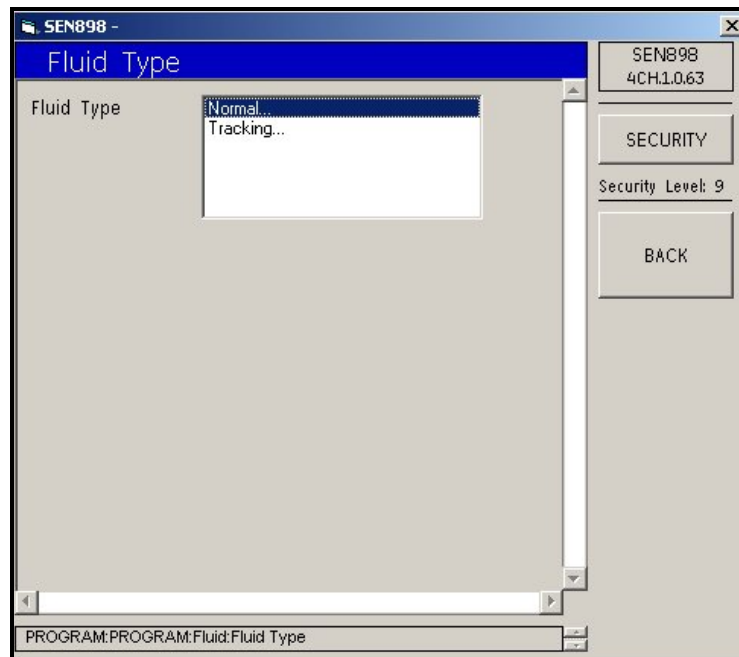
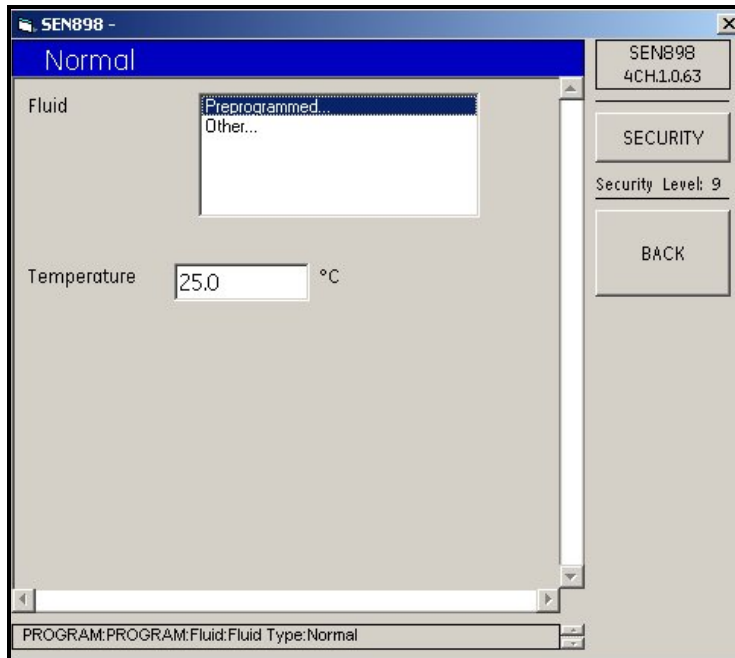

Figure 85: Fluid Type Menu

## 5.7.2 Fluid Setup (cont.)

- If the fluid is a normal type, click twice on Normal. The following screen appears.



**Figure 86: Normal Fluid Menu**

- If the fluid is standard, click twice on Preprogrammed... The following screen appears.

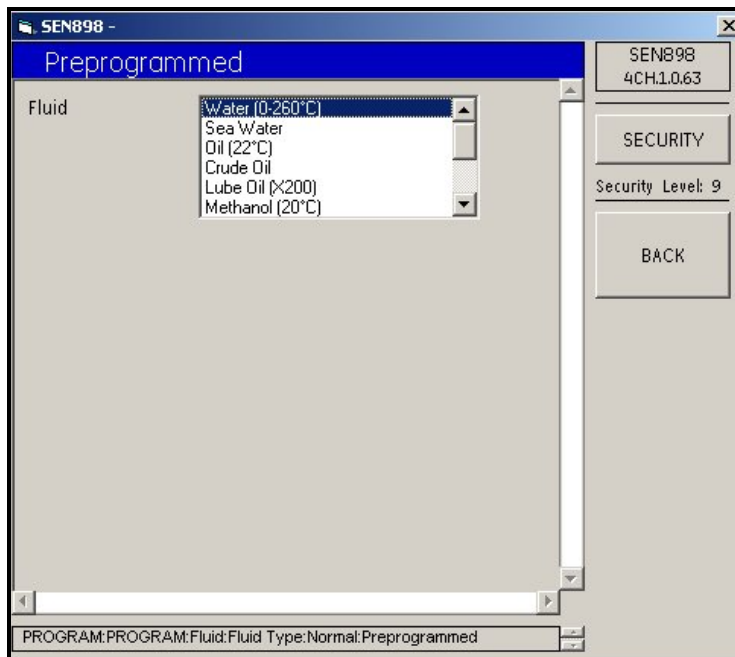
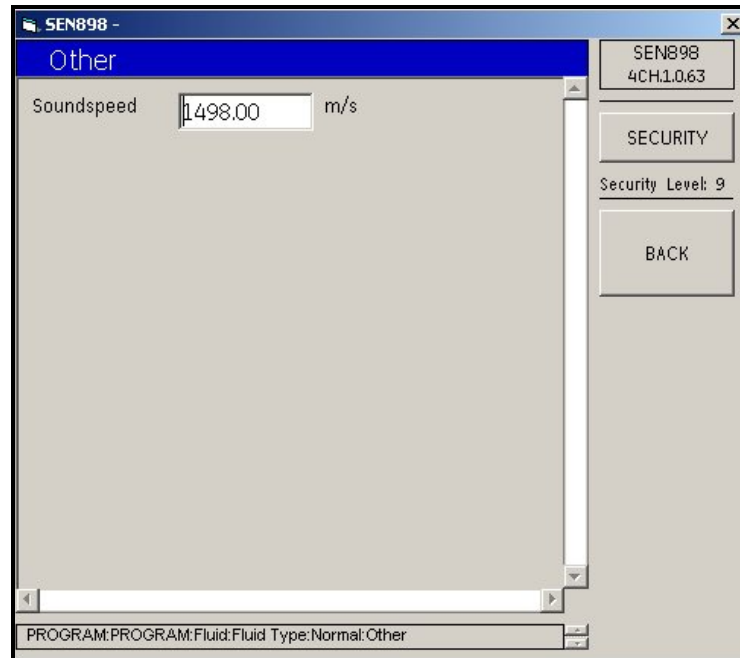

**Figure 87: Preprogrammed Fluid Menu**

- Select the correct fluid from the list and click on it twice. The window returns to the Normal screen.

## 5.7.2 Fluid Setup (cont.)

- If the fluid is not standard, on the Normal screen click twice on Other... and the following screen appears.



**Figure 88: Other Fluid Screen**

- Enter the fluid soundspeed, click on BACK, and click Yes to verify, or No to reject, the change. Click on BACK.
- On the Normal screen, to change the fluid Temperature, enter a new value into the text box and follow the procedure above.
- If the fluid type is not normal, on the Fluid Type screen click twice on Tracking... and the following screen appears.

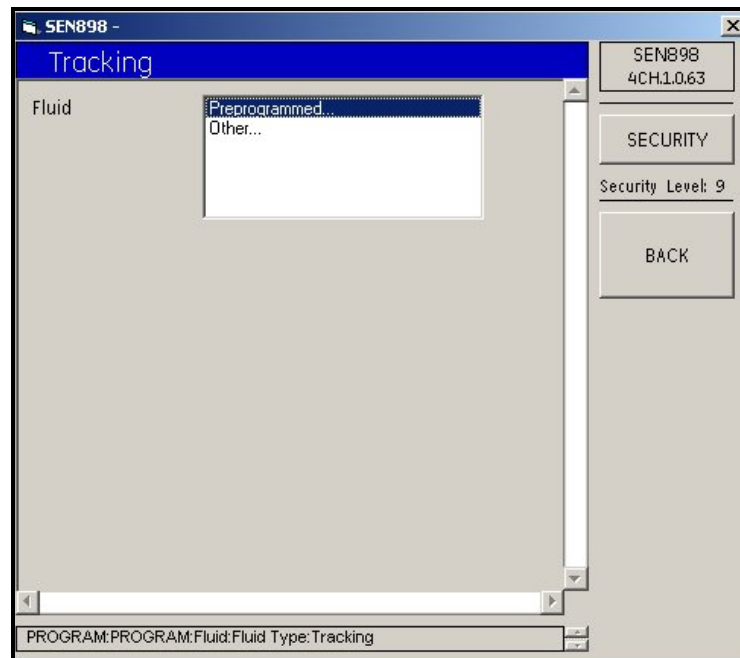

**Figure 89: Tracking Screen**

## 5.7.2 Fluid Setup (cont.)

10. If the fluid type is not standard, on the Tracking screen, click twice on Other and the following screen appears.

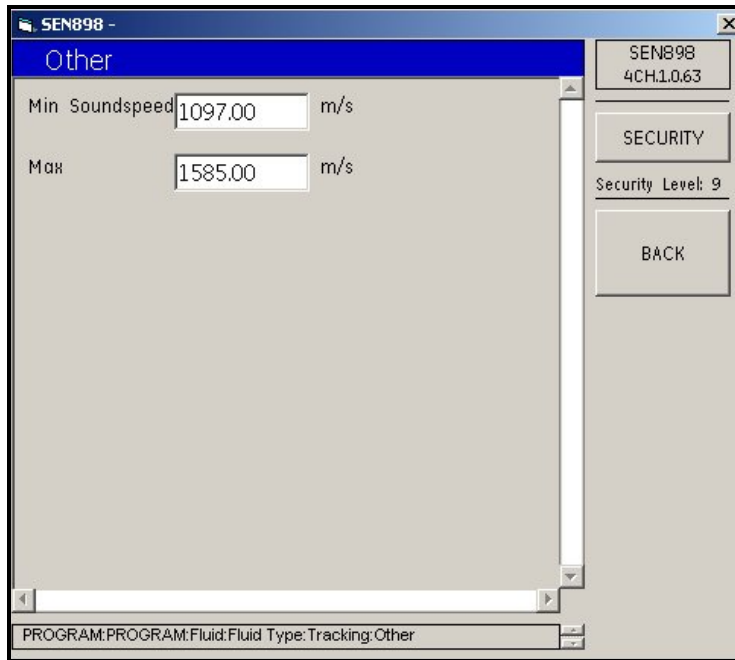
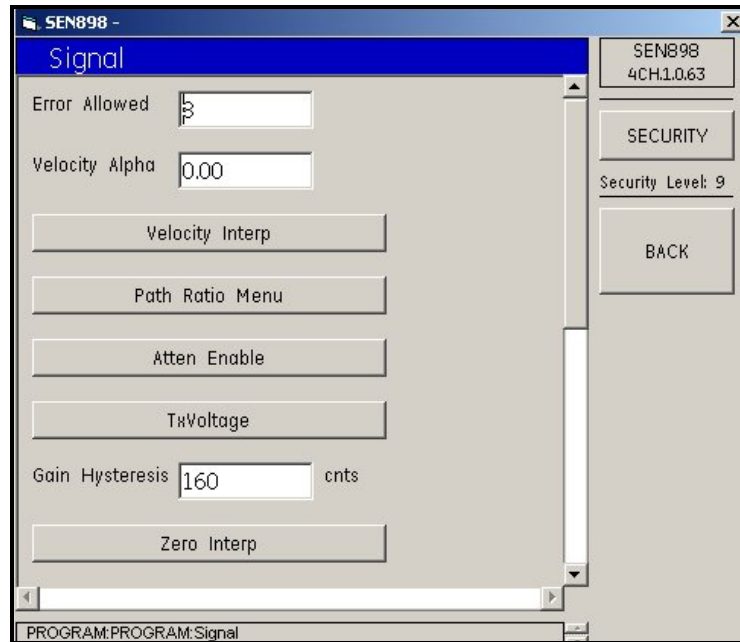

**Figure 90: Other Fluid Menu**

11. Enter the fluid Minimum and/or Maximum Soundspeed, click on BACK, and click Yes to verify, or No to reject the change. When the Fluid changes are complete, click on BACK to return to the composite Program menu.

### 5.7.3 Signal Setup

1. To set up or make changes to the signal values, click on Signal and the following screen appears.

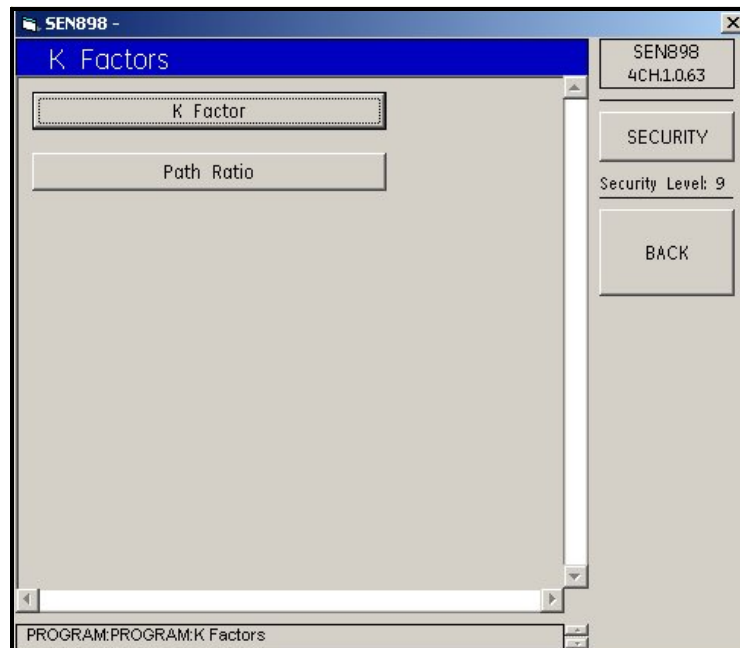

**Figure 91: Editing Signal Values**

2. Click on the categories that need to be set, select the appropriate type from each list, and make changes to the text boxes as needed.

### 5.7.4 K Factors Setup

1. To set up the K Factors, from the Program screen, click on K Factors and the following screen appears.



**Figure 92: K Factors Menu**

### 5.7.4 K Factors Setup (cont.)

- Click on K Factor and the following screen appears.

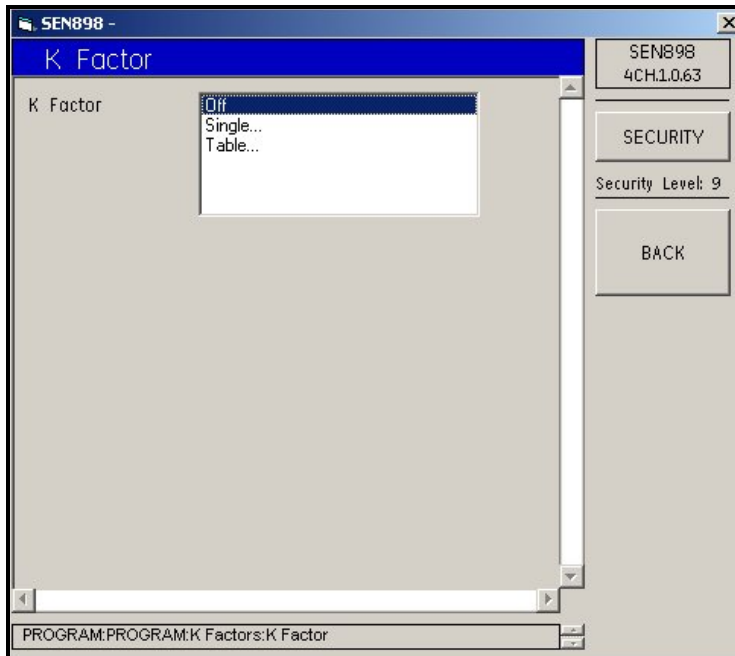

Figure 93: K Factor Options

- To change a single K Factor, click twice on Single.... The following screen appears.

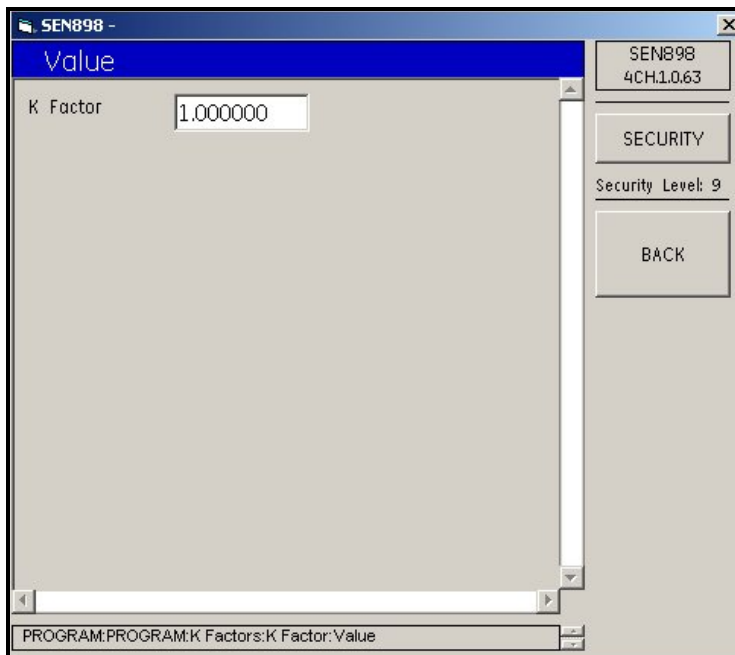
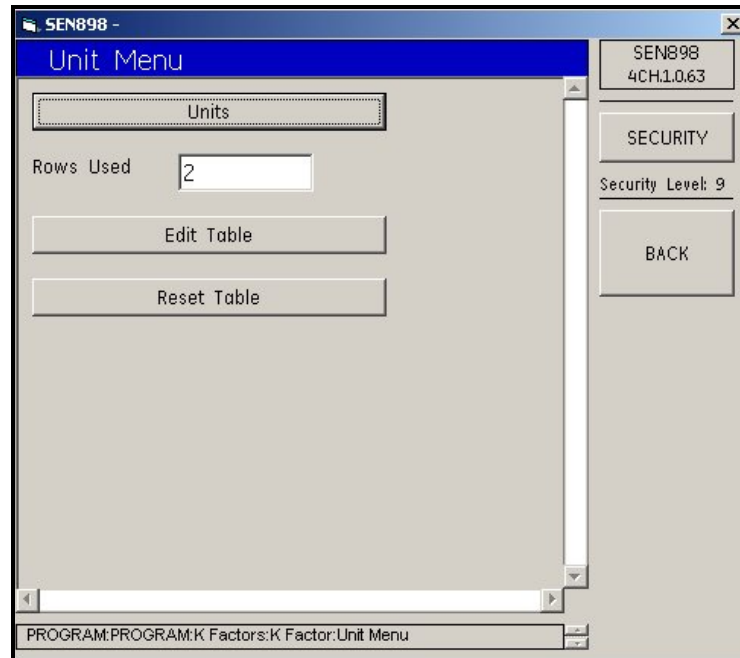

Figure 94: K Factor Value Option

- Enter the K factor and click on BACK. Click Yes to verify, or No to reject, the new K Factor, and click on BACK.

### 5.7.4 K Factors Setup (cont.)

5. On the K Factor screen, to change multiple K factors, click on Table... The following screen appears.



**Figure 95: K Factor Unit Menu**

6. Click on Units and the following screen appears.

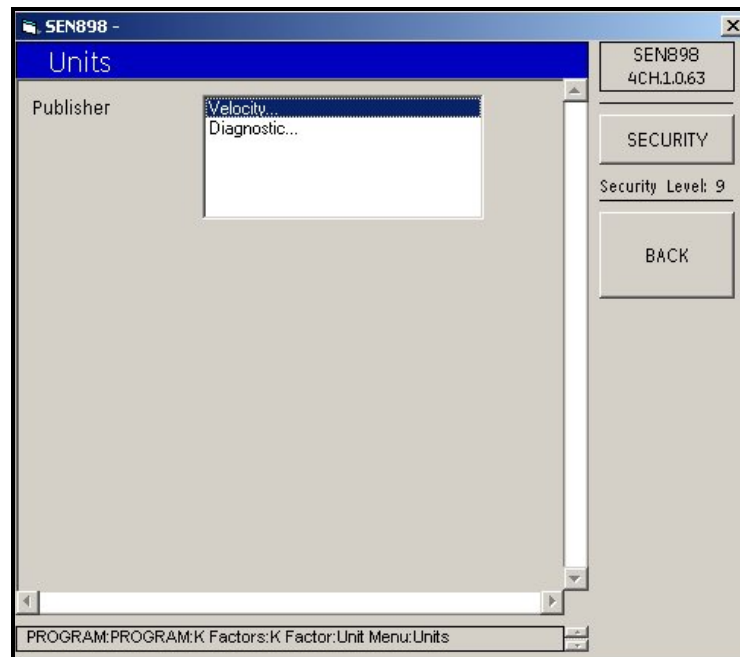

**Figure 96: Units Publisher Menu**

7. To check the velocity unit of measure, click twice on Velocity... and the screen shows the unit. Click BACK. To check the diagnostic unit, click twice on Diagnostic... and the screen shows the unit. Click BACK. Click BACK again to return to the Unit Menu.

### 5.7.4 K Factors Setup (cont.)

8. Click on Edit Table and the following screen appears.

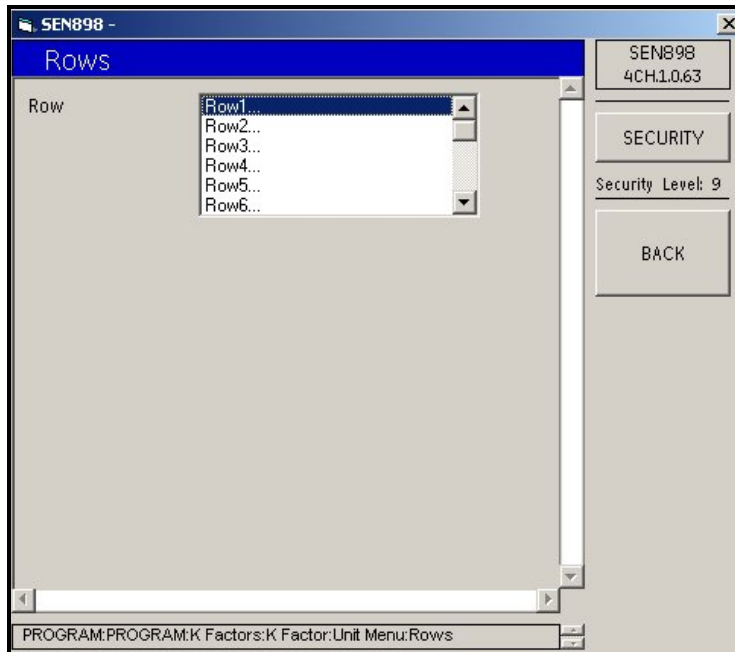

Figure 97: Rows Menu

9. Click twice on the row to be changed and the following screen appears.

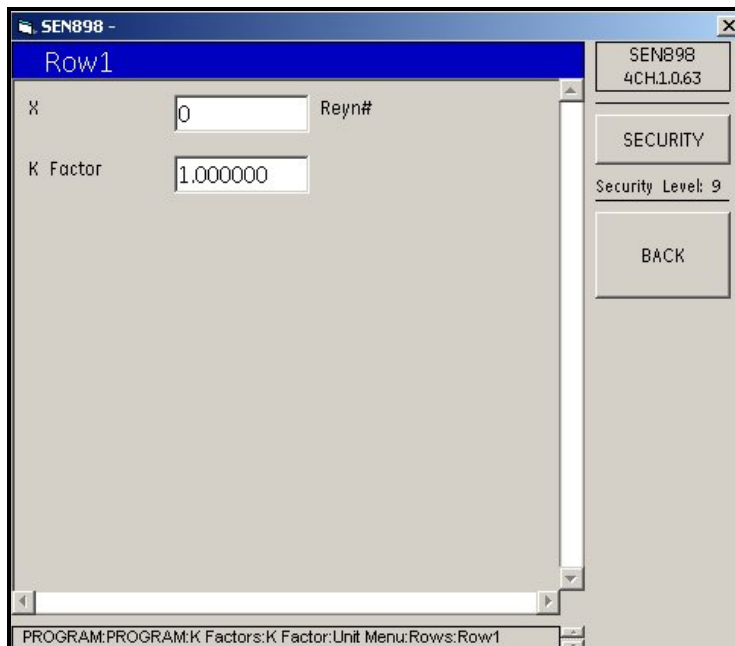

Figure 98: Row Menu

10. Enter a new Reynolds # and/or K Factor, click on BACK, click Yes to verify, or No to reject, the new X and/or K Factor values, and click on BACK.
11. When the Row changes are complete, click on BACK to return to the Unit menu.



### 5.7.4 K Factors Setup (cont.)

12. To confirm the unit changes, click on Reset Table and the following screen appears.

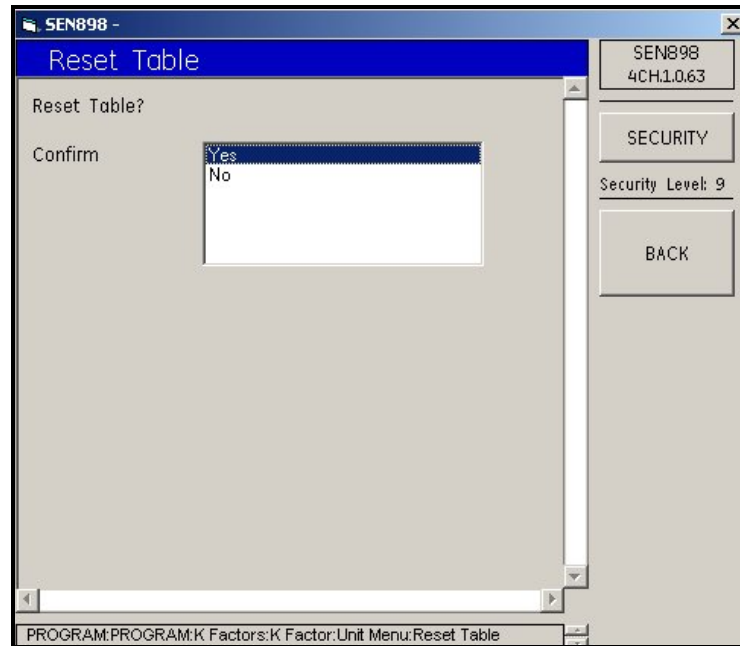

Figure 99: Reset Table Menu

13. To confirm the reset, click Yes. To reject the reset, click No. The screen returns to the Unit Menu. Click on BACK twice to return to the K Factor Menu.
14. Click on Path Ratio and the following screen appears.

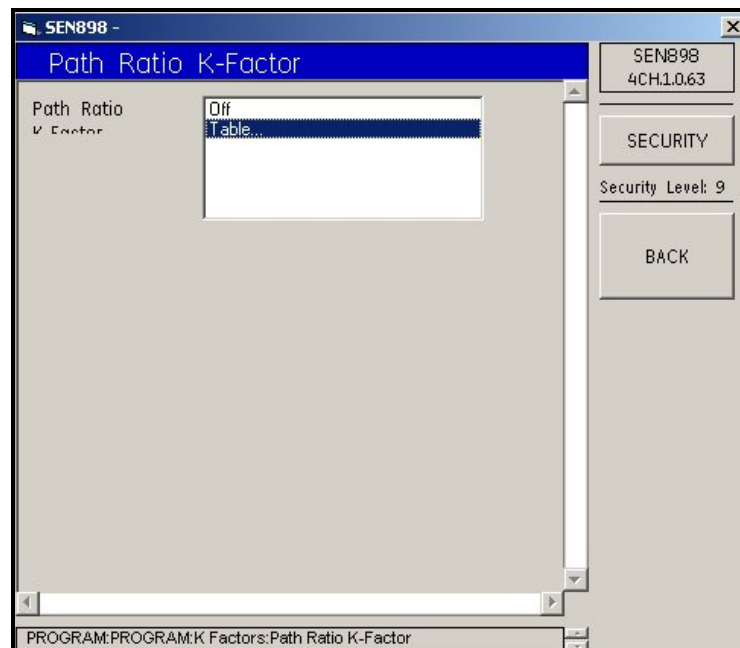

Figure 100: Path Ratio K-Factor Menu

15. To turn off the Path Ratio K-Factor, click Off... twice. The screen returns to the K Factors Menu. To edit the path ratio K factor, click twice on Table... and follow the previous instructions in Steps 10 through 15.

## 5.7.5 Weight Factors Setup

1. From the composite Program menu, click on Weight Factors, and the following screen appears.

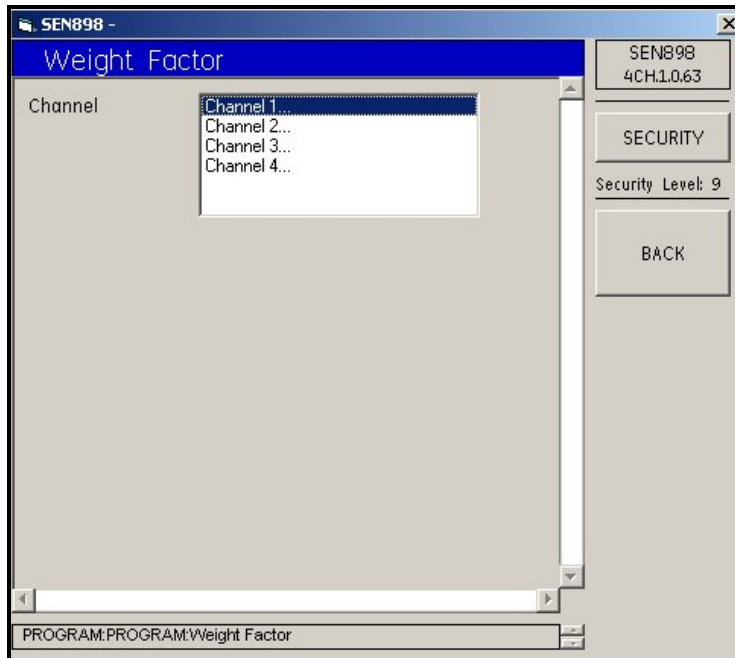

Figure 101: Weight Factor Menu

2. Click twice on the channel to be changed and the following screen appears. Enter the new weight into the text box and click on BACK. Click Yes to confirm the change or click No to reject the change. Click twice on BACK to return to the composite Program menu.

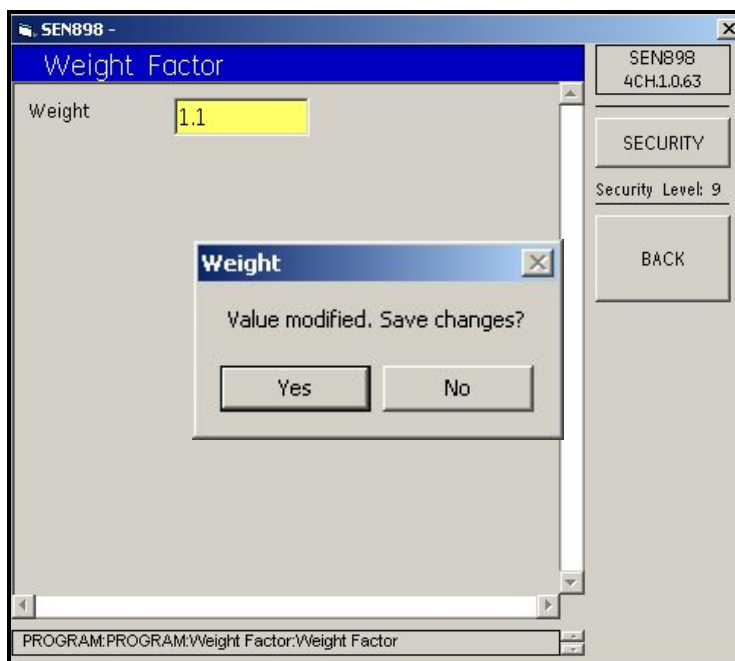
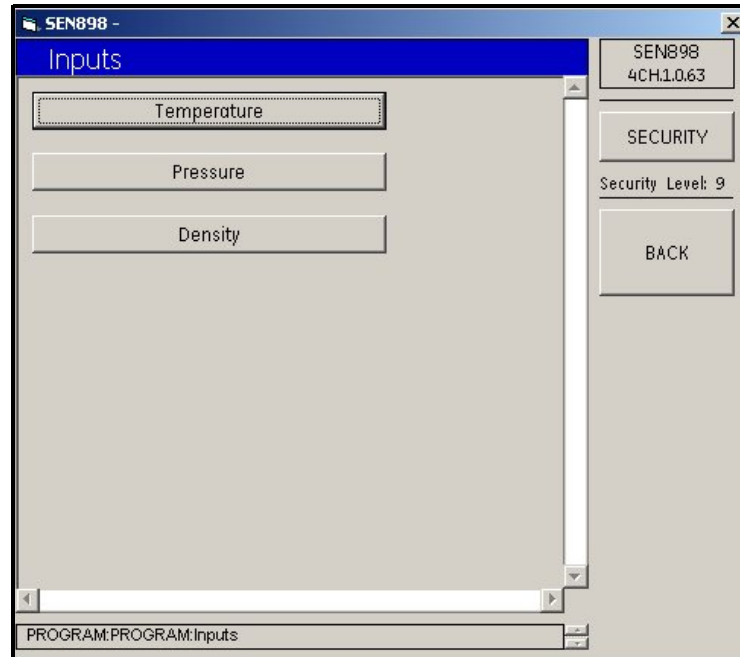

Figure 102: Weight Verification Screen

## 5.7.6 Inputs Setup

1. From the composite Program menu, click on Inputs and the following screen appears.



**Figure 103: Inputs Menu**

2. To change the input temperature, click on Temperature, and the following screen appears.

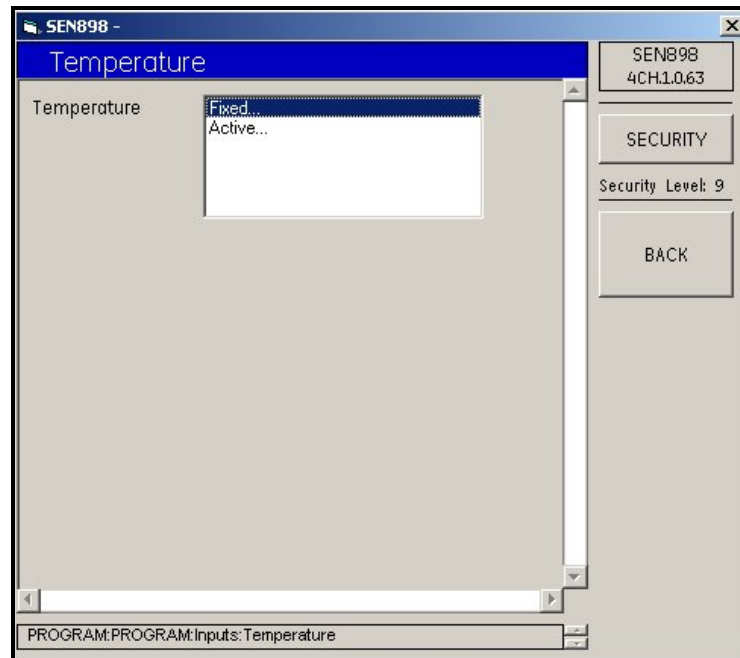

**Figure 104: Temperature Menu**

### 5.7.6 Inputs Setup (cont.)

3. To set a fixed temperature, click twice on Fixed... and the following screen appears.

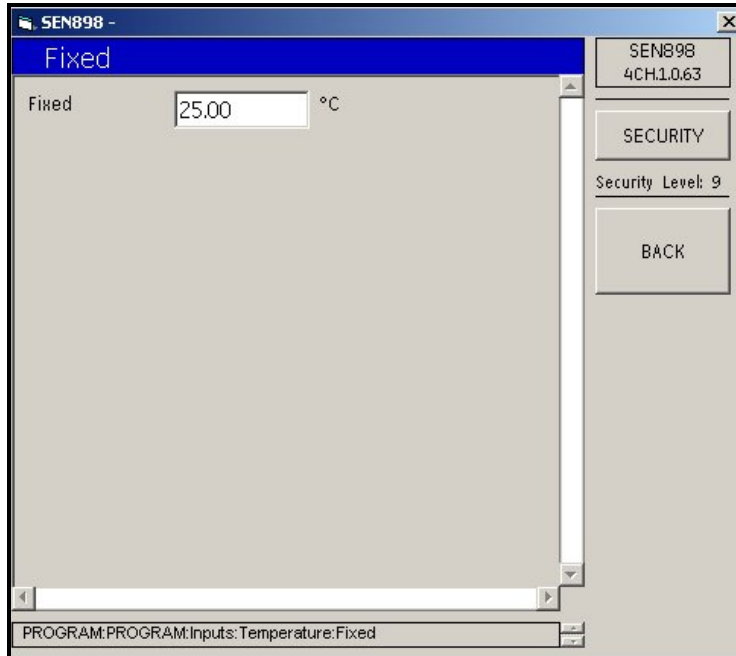

Figure 105: Fixed Temperature Screen

4. Enter the appropriate fixed temperature value into the text box and click on BACK. Click Yes to confirm the change or click No to reject it. Click on BACK and return to the Temperature menu.

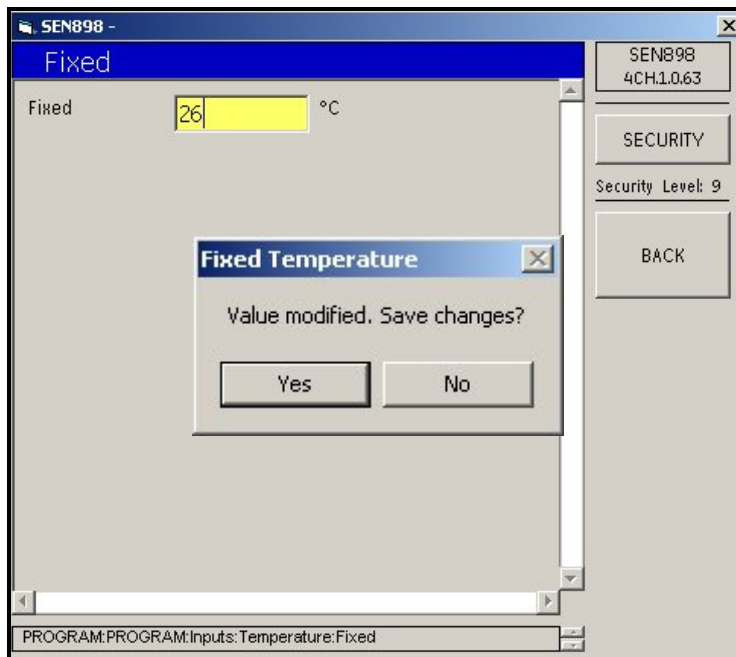
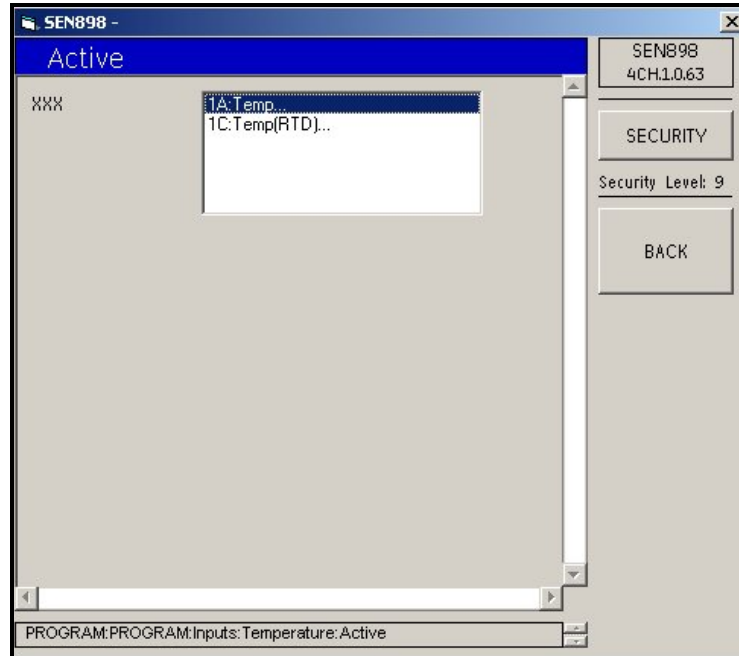

Figure 106: Fixed Temperature Verification Screen

### 5.7.6 Inputs Setup (cont.)

5. To select an active temperature, from the Temperature menu click twice on Active... The following screen appears.



**Figure 107: Active Temperature Menu**

6. Click twice on the appropriate temperature and the screen returns to the Temperature menu.
7. Click on BACK to return to the Inputs menu and click on Pressure. The following screen appears.

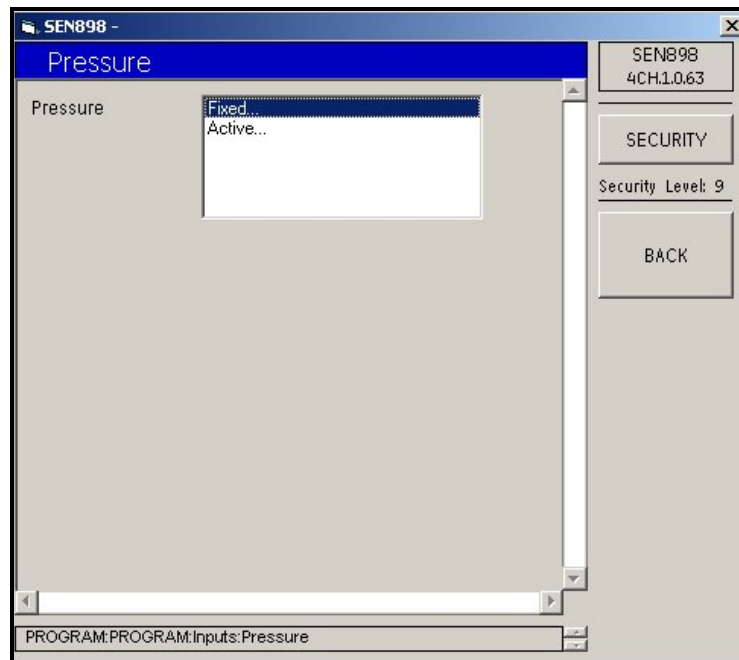

**Figure 108: Pressure Menu**

## 5.7.6 Inputs Setup (cont.)

- To set a fixed pressure, click twice on Fixed... and the following screen appears.

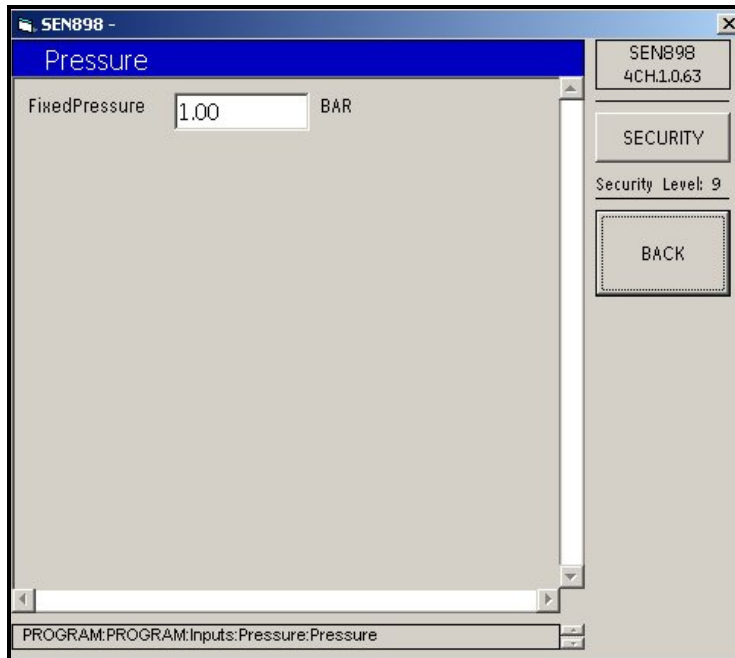

Figure 109: Fixed Pressure Screen

- Enter the appropriate fixed pressure value into the text box and click on BACK. Click Yes to confirm the change or click No to reject it. Click on BACK and return to the Pressure menu.

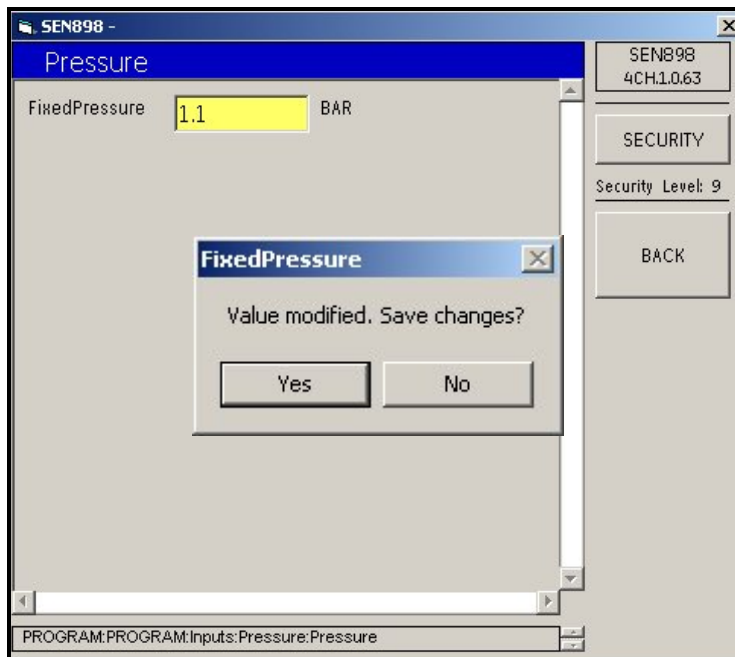

Figure 110: Fixed Pressure Verification Screen

### 5.7.6 Inputs Setup (cont.)

10. To select an active pressure, from the Pressure menu click twice on Active... The following screen appears.

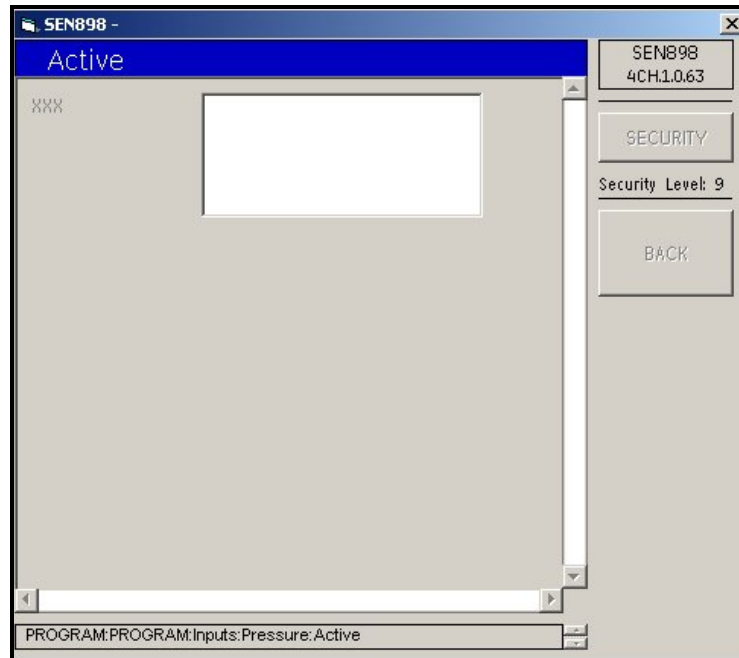

Figure 111: Active Pressure Menu

11. Click twice on the appropriate pressure and the screen returns to the Pressure menu.
12. Click on BACK to return to the Inputs menu and click on Density. The following screen appears.

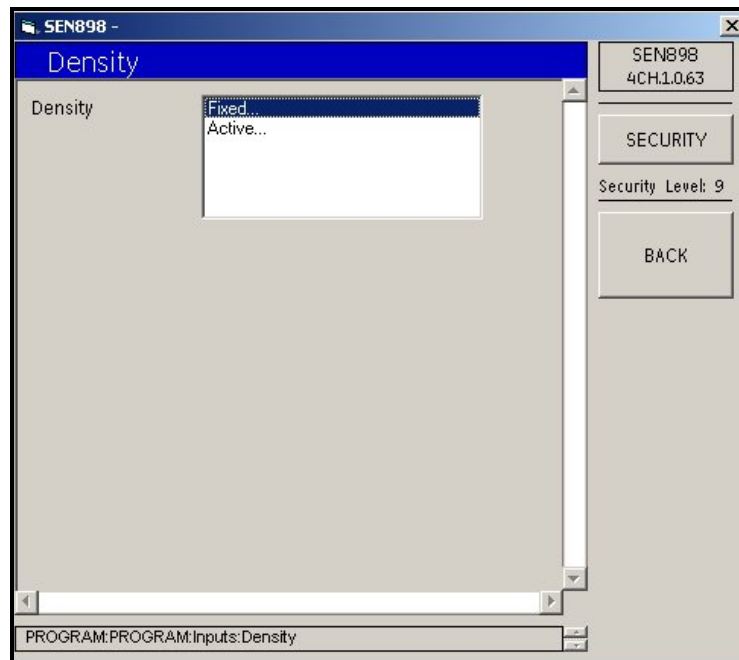

Figure 112: Density Menu

## 5.7.6 Inputs Setup (cont.)

13. To set a fixed density, click twice on Fixed... and the following screen appears.

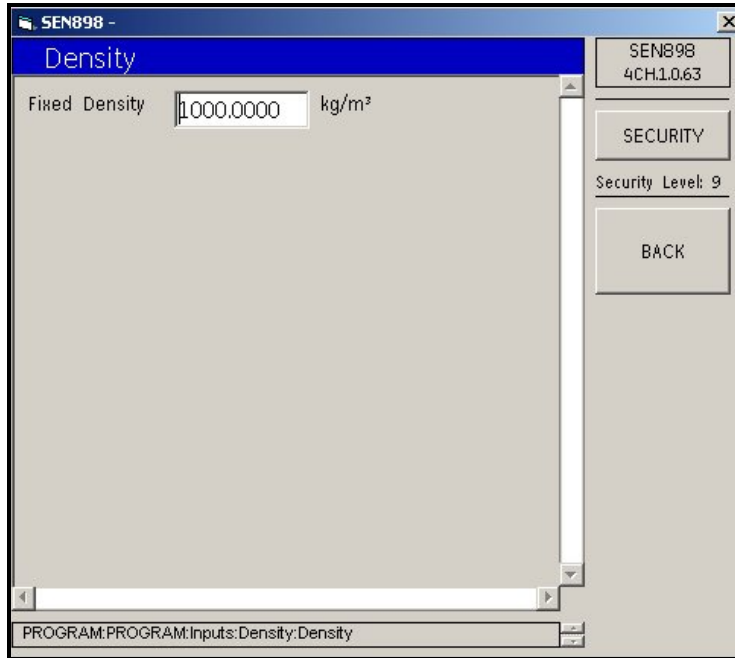

Figure 113: Fixed Density Screen

14. Enter the appropriate fixed density value into the text box and click on BACK. Click Yes to confirm the change or click No to reject it. Click on BACK and return to the Density menu.

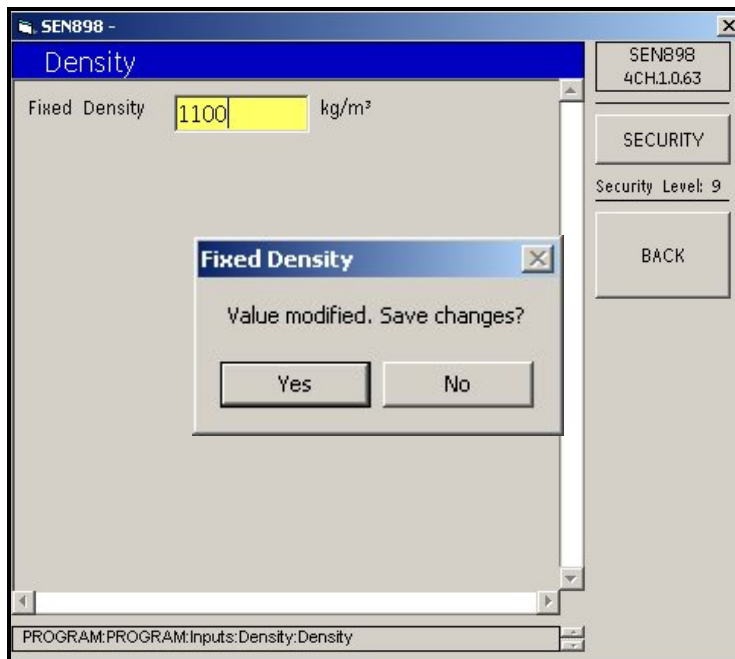

Figure 114: Fixed Density Verification Screen



### 5.7.6 Inputs Setup (cont.)

15. To select an active density, from the Density menu click twice on Active... The following screen appears.

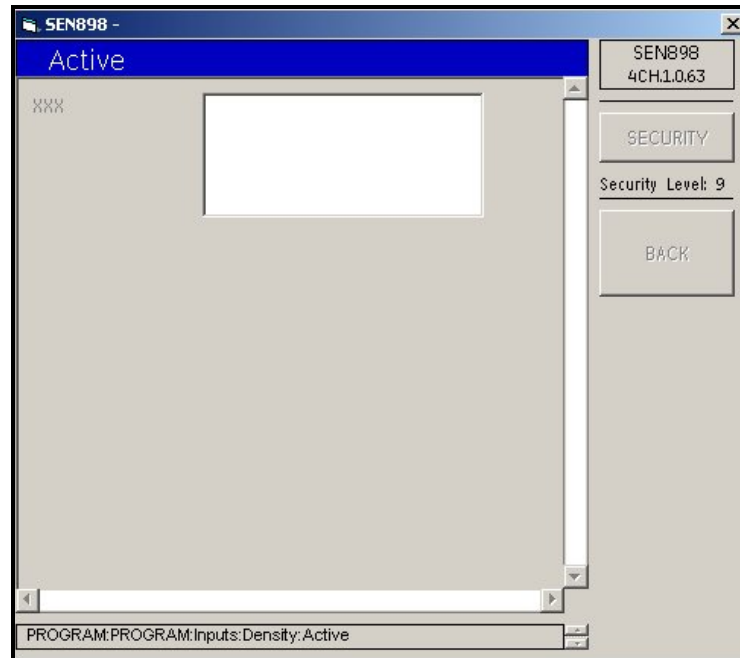

Figure 115: Active Density Menu

16. Click twice on the appropriate density and the screen returns to the Density menu. Click twice on BACK to return to the composite Program menu.

### 5.7.7 API Setup

From the composite Program menu, click on API Setup. The following screen appears.

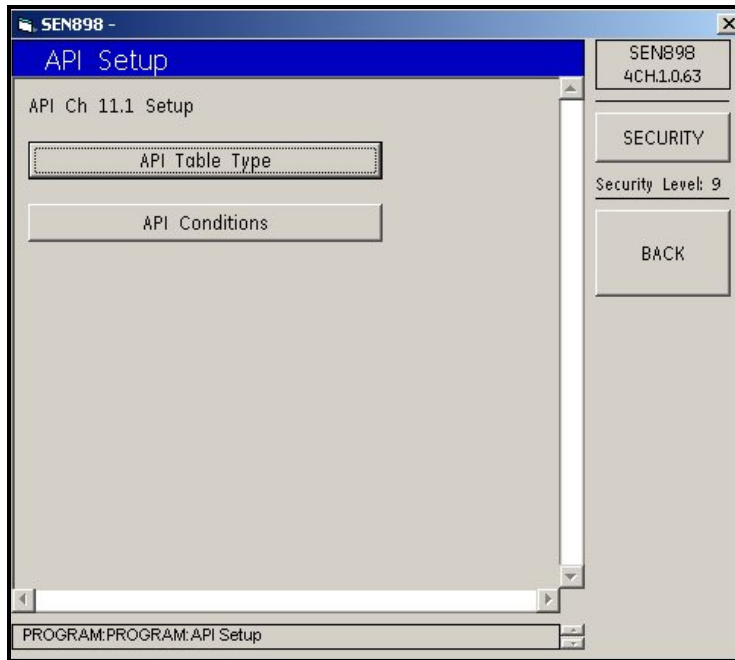

Figure 116: API Setup Menu

17. To select the type of table, click on API Table Type . The following screen appears.

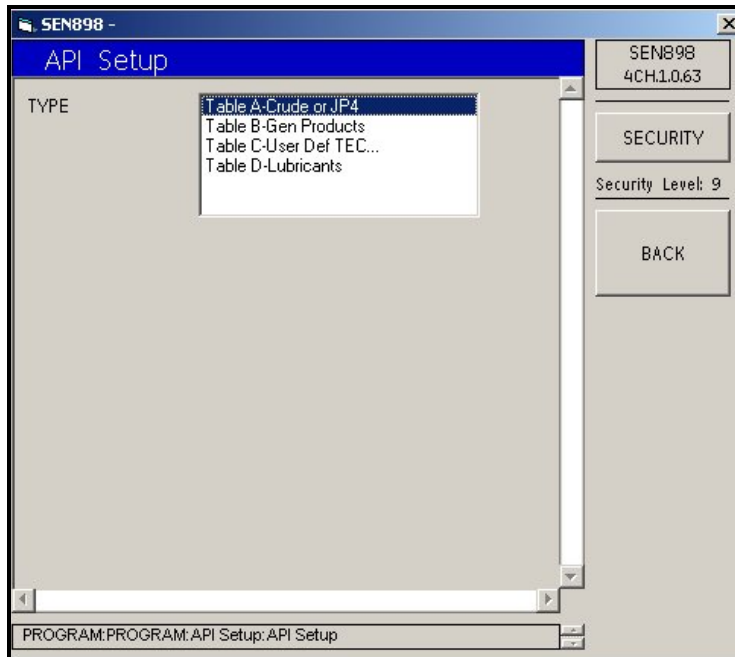

Figure 117: Table Type Menu

18. Click twice on the appropriate selection, and the screen returns to the API Setup Menu.

### 5.7.7 API Setup (cont.)

19. To set up API conditions, click on API Conditions, and the following screen appears.

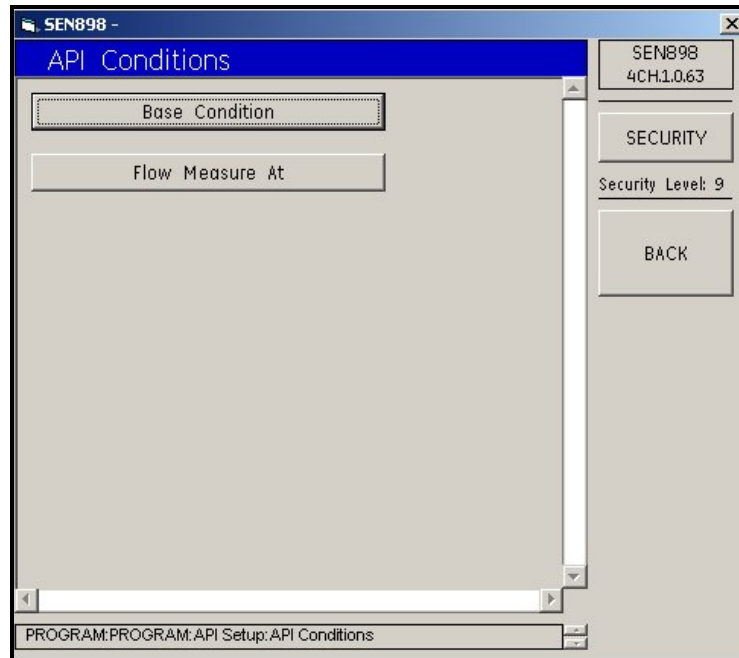

Figure 118: API Conditions Menu

20. Click on Base Conditions and the following screen appears.

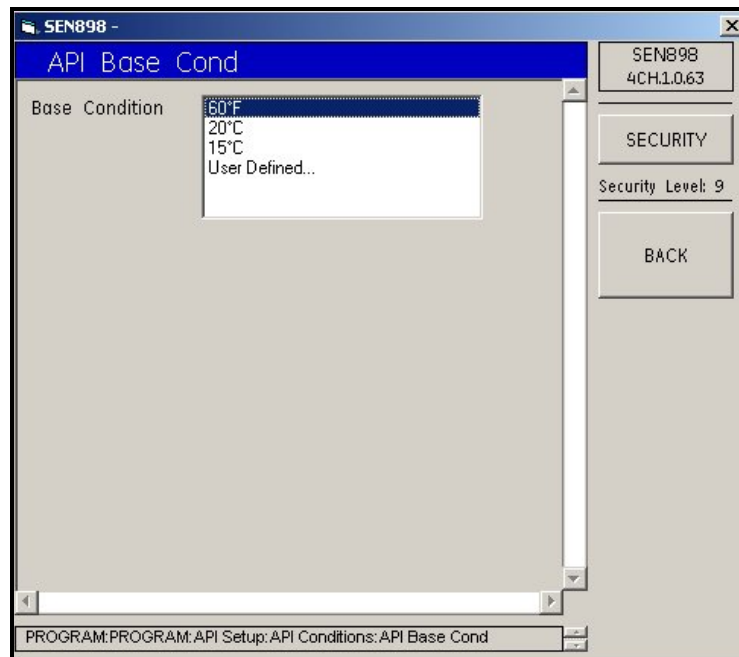

Figure 119: API Base Conditions Menu

### 5.7.7 API Setup (cont.)

21. If you click twice on a numeric entry, the screen returns to the API Conditions menu. If you select User Defined..., the following screen appears.

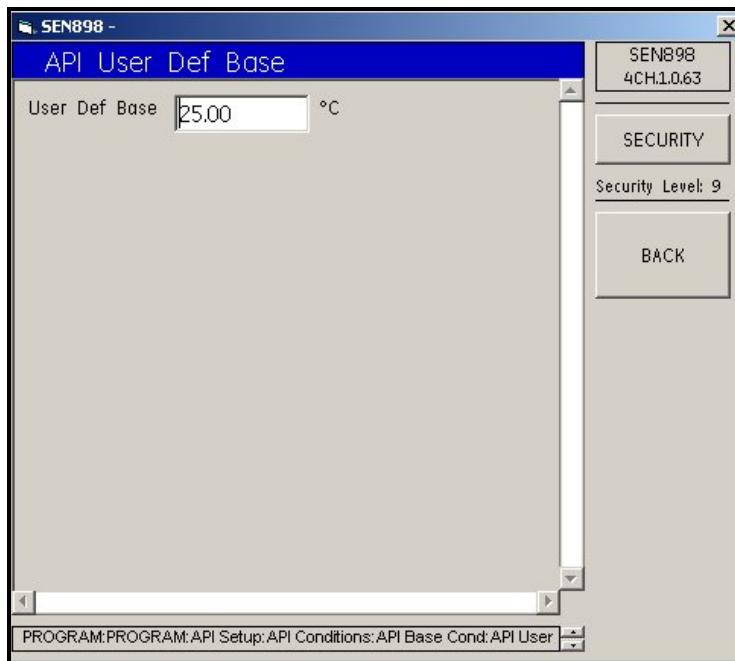

Figure 120: API User Defined Base Condition

22. Enter the appropriate user defined base value into the text box and click on BACK. Click Yes to confirm the change or click No to reject it. Click on BACK and return to the API Base Condition menu.

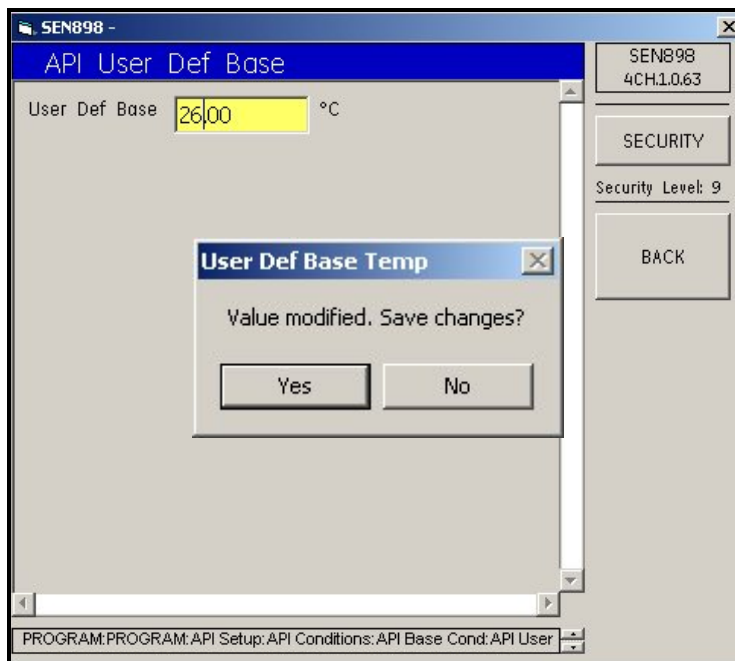

Figure 121: User Defined Base Temperature Verification Screen

### 5.7.7 API Setup (cont.)

23. Click on BACK to return to the API Conditions menu. To provide Flow Measurement settings, click on Flow Measure At, and the following screen appears.

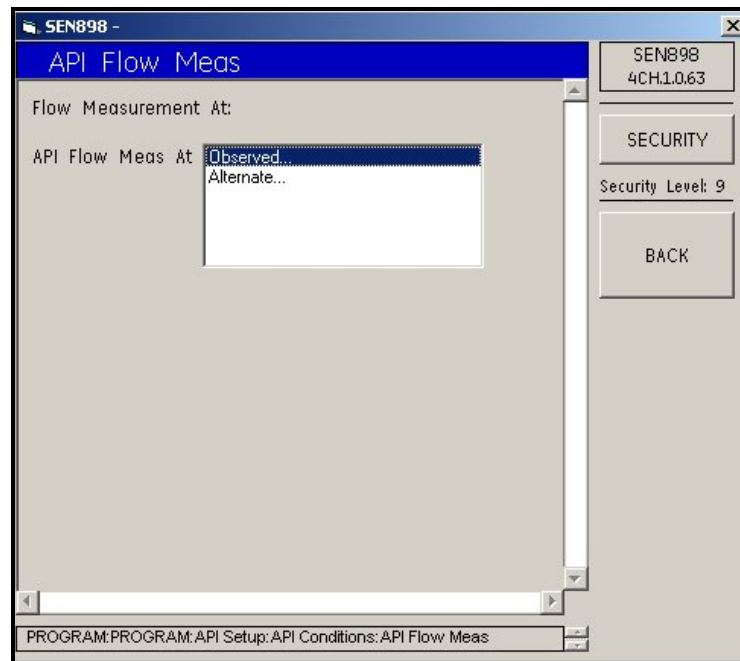

Figure 122: API Flow Measurement Menu

24. Click on Observed... and the following screen appears.

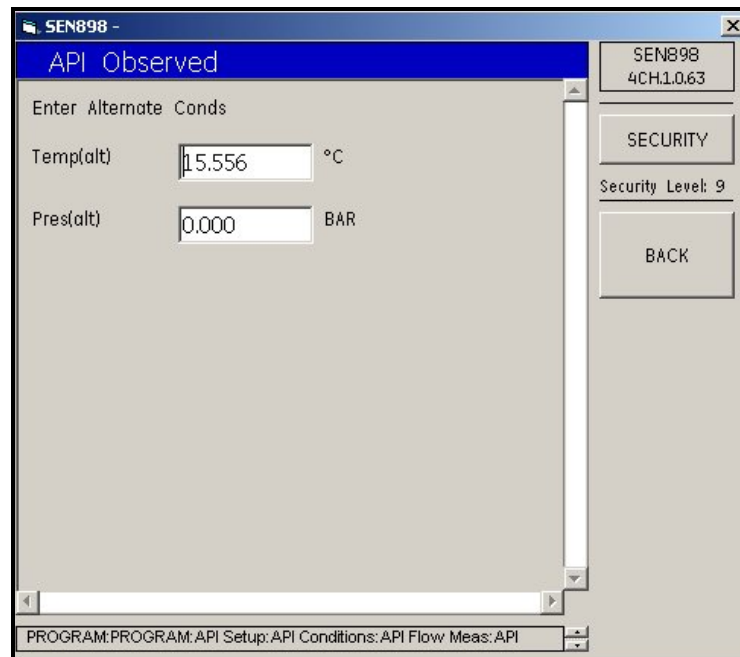

Figure 123: API Observed Alternate Conditions Screen

### 5.7.7 API Setup (cont.)

25. If changes are required, enter the appropriate condition into the text box and click on BACK. Click Yes to confirm the change or click No to reject it. Repeat the process for the other condition if necessary, then click on BACK and return to the API Flow Measurement menu.

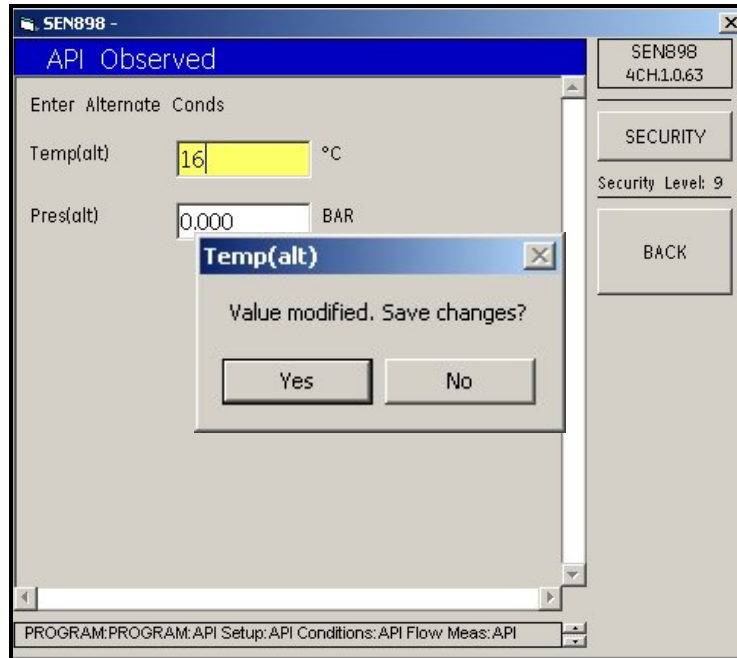

Figure 124: Temp(alt) Verification Screen

26. To check alternate Flow Measurement settings, click on Flow Measure At. The following screen appears.

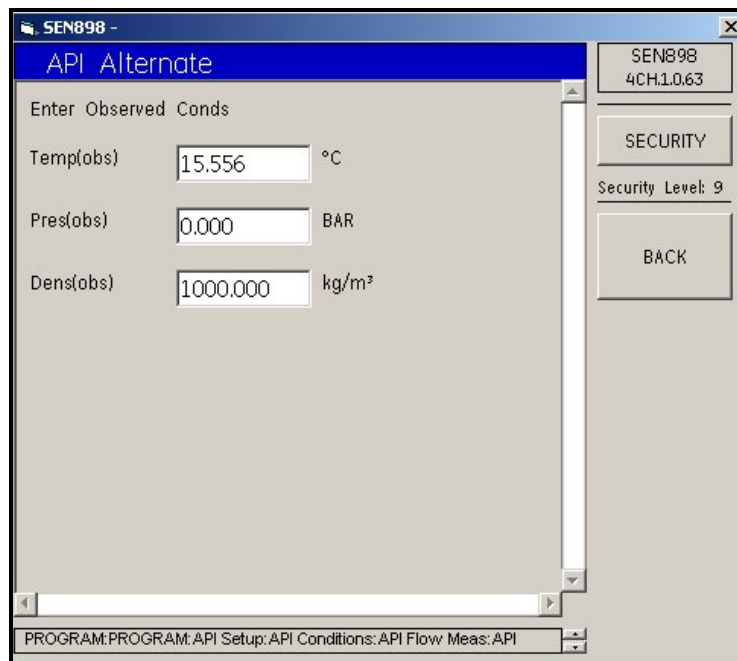

Figure 125: API Alternate Observed Conditions Screen

### 5.7.7 API Setup (cont.)

27. If changes are required, enter the appropriate condition into the text box and click on BACK. Click Yes to confirm the change, or click No to reject it. Repeat the process for the other conditions if necessary, then click on BACK five times and return to the original Program menu.

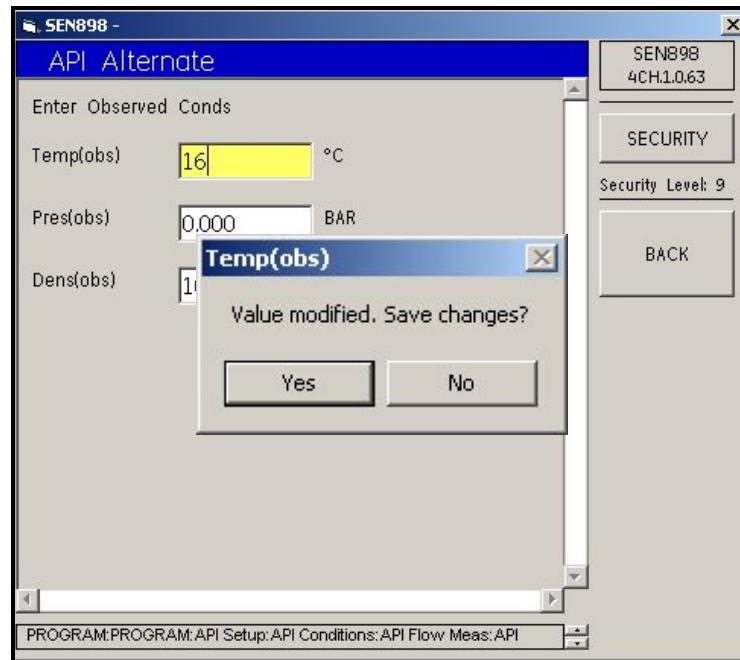

Figure 126: Temp(obs) Verification Screen

28. Exit the original Program menu by clicking the X in the upper right-hand corner of the screen.

## 5.8 Configuration Menu

### 5.8.1 Units Setup

1. To set up data configuration, click twice on Config Menu and the following screen appears.

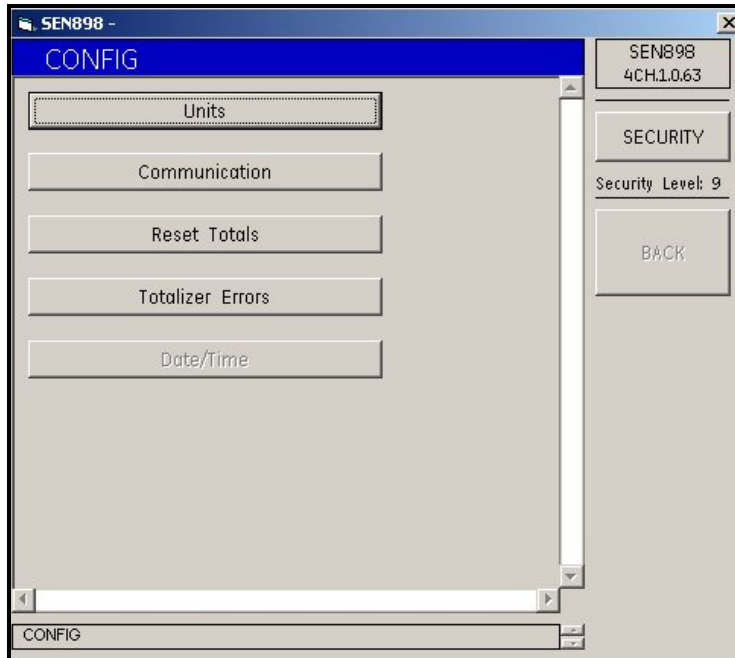

Figure 127: Configuration Menu

2. To select the type of units, click on Units. The following screen appears.

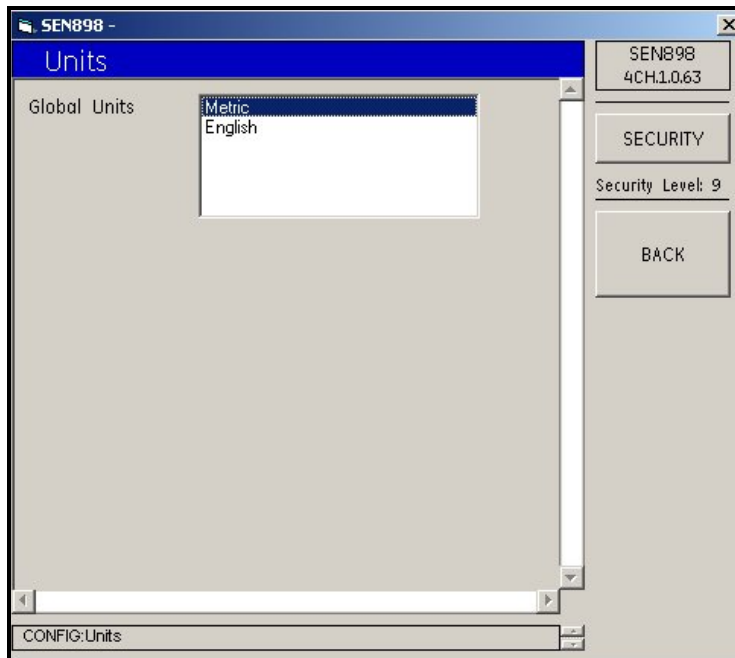

Figure 128: Units Menu

3. Click twice on Metric or English. The screen returns to the Config menu.



## 5.8.2 Communication Setup

- To select a type of communication, click on Communication. The following screen appears.

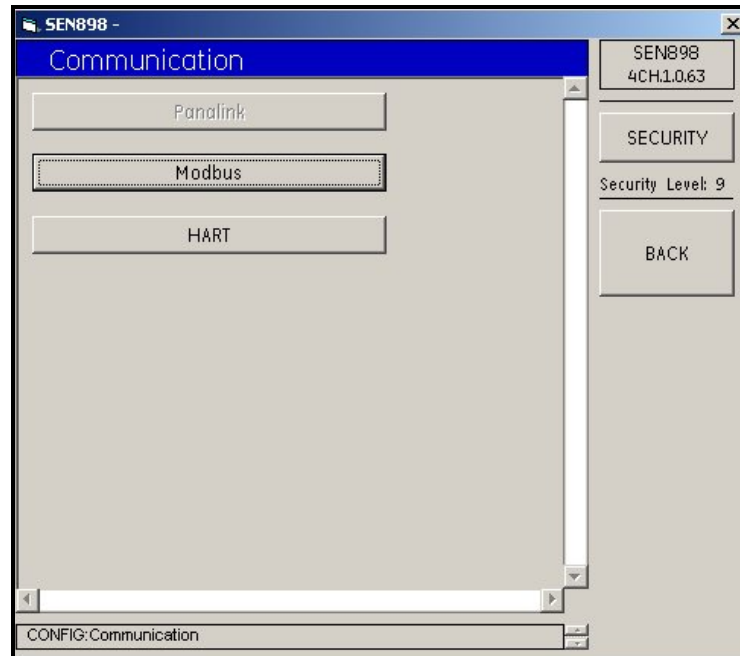

Figure 129: Communication Menu

### 5.8.2.1 Modbus

- To set up Modbus communications, click on Modbus. The following screen appears.

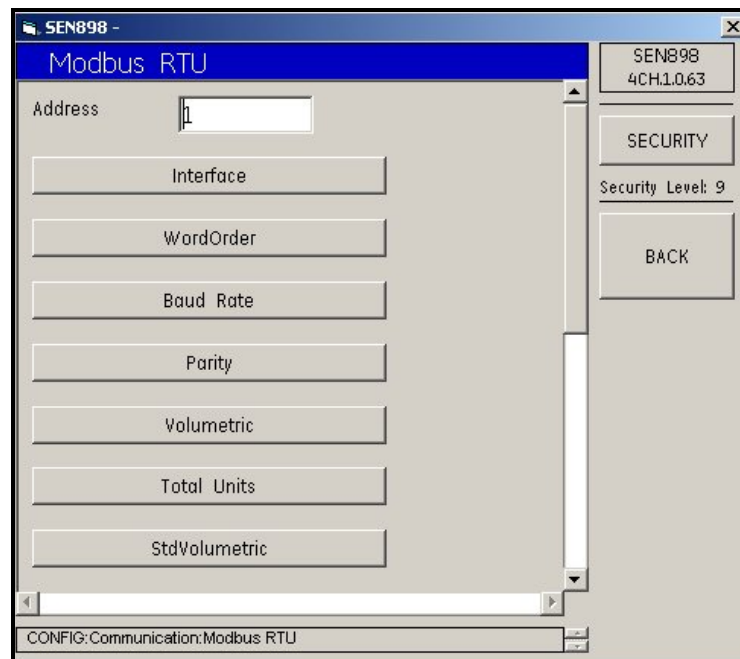

Figure 130: Modbus RTU Menu

### 5.8.2.1 Modbus (cont.)

- To change the Modbus address, enter the appropriate number into the text box and click on BACK. Click Yes to confirm the change, or click No to reject it. Click on BACK to return to the Communication screen.

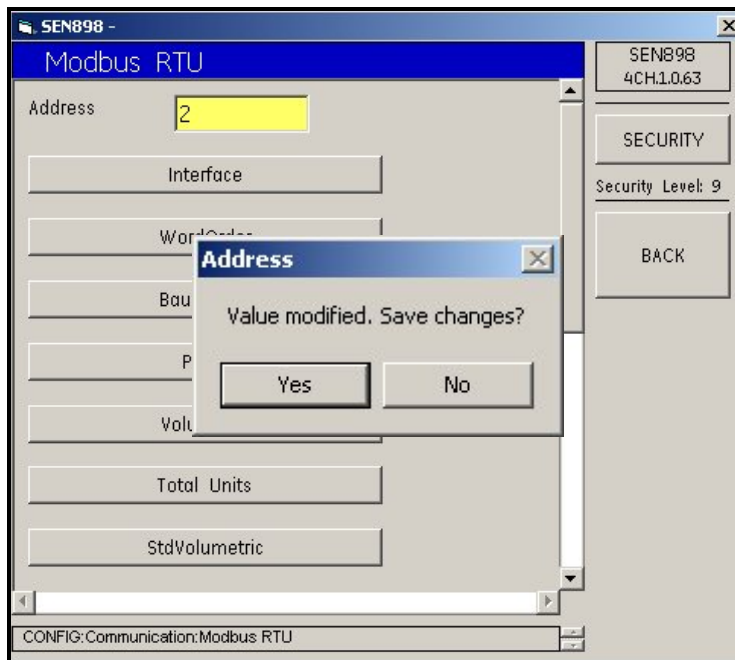

Figure 131: Modbus Address Verification Screen

- To select the interface to be used, click on Interface. The following screen appears.

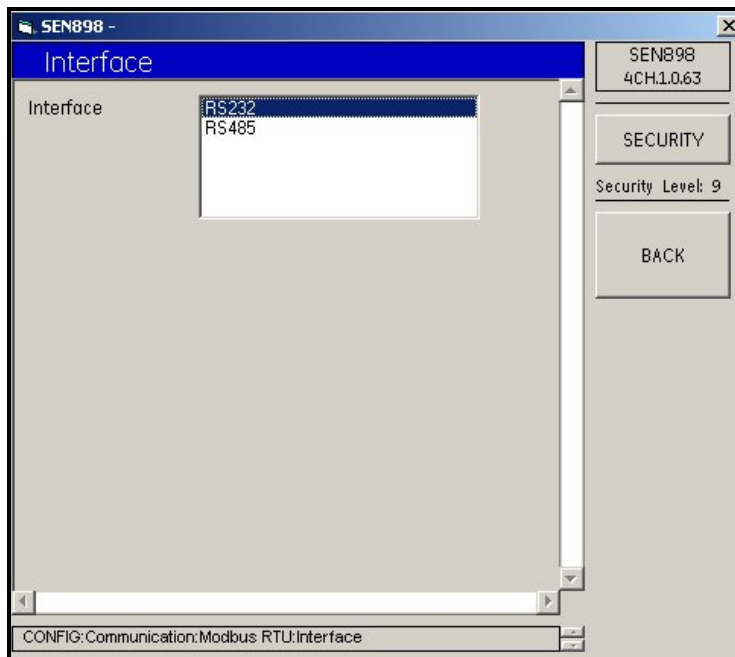

Figure 132: Interface Menu

- Click twice on your selection, and the screen returns to the Modbus RTU menu.

### 5.8.2.1 Modbus (cont.)

5. To select a word order to be used, click on WordOrder. The following screen appears.

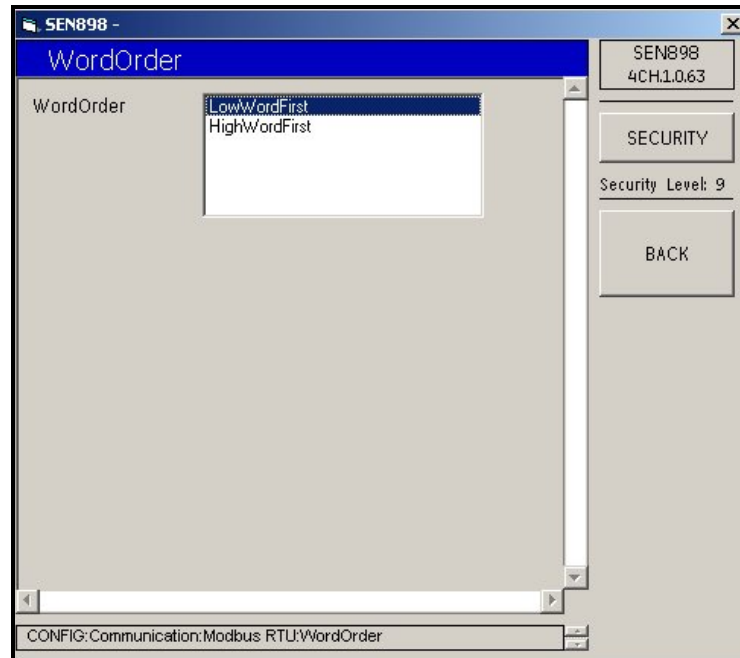

Figure 133: Word Order Menu

6. Click twice on your selection, and the screen returns to the Modbus RTU menu.

7. To select a baud rate, click on Baud Rate. The following screen appears.

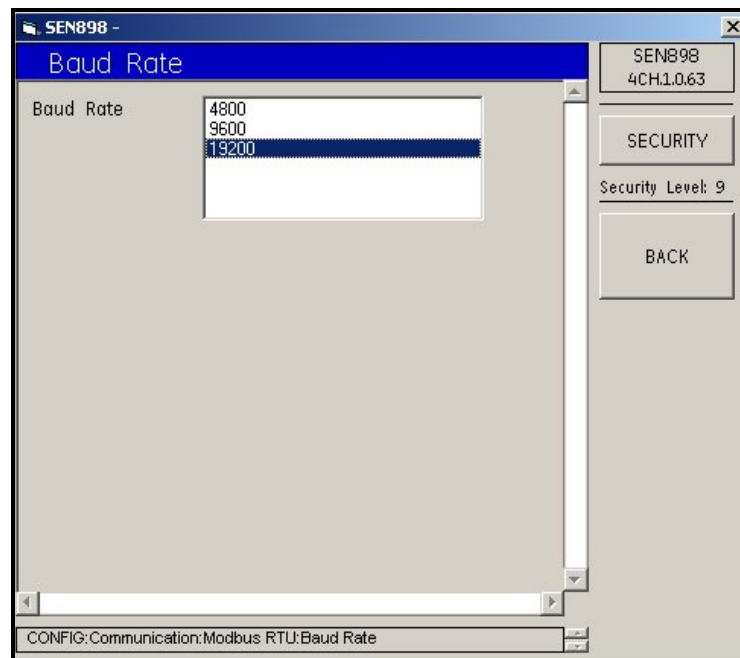
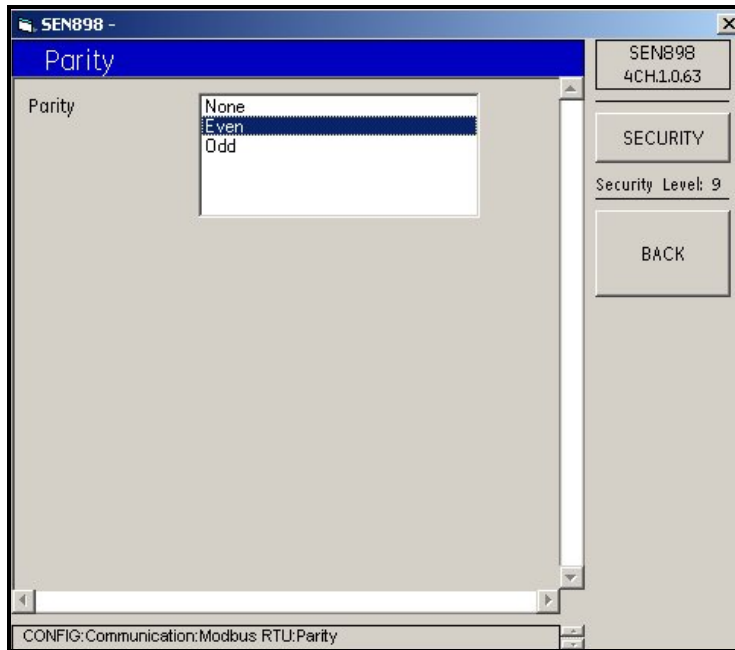

Figure 134: Baud Rate Menu

8. Click twice on your selection, and the screen returns to the Modbus RTU menu.

### 5.8.2.1 Modbus (cont.)

9. To select a parity, click on Parity. The following screen appears.



**Figure 135: Parity Menu**

10. Click twice on your selection, and the screen returns to the Modbus RTU menu.

11. To select a volumetric unit, click on Volumetric. The following screen appears.

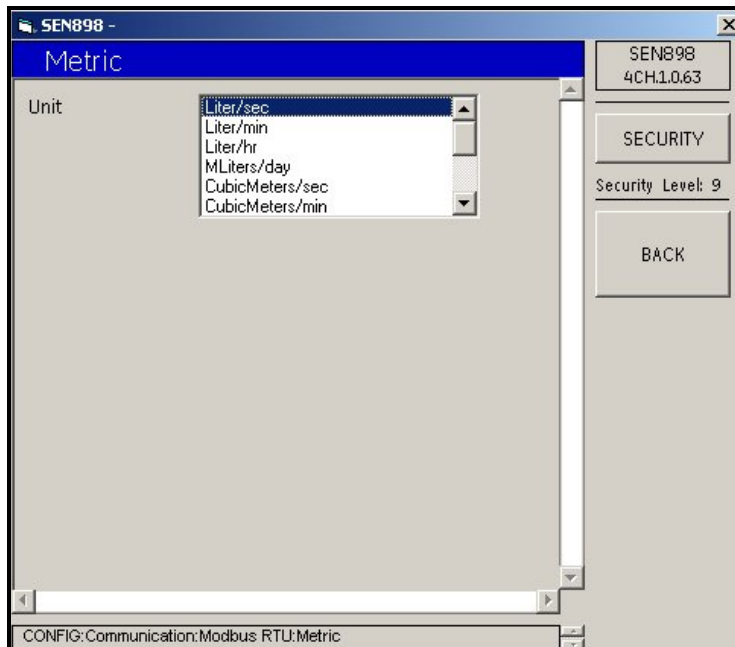
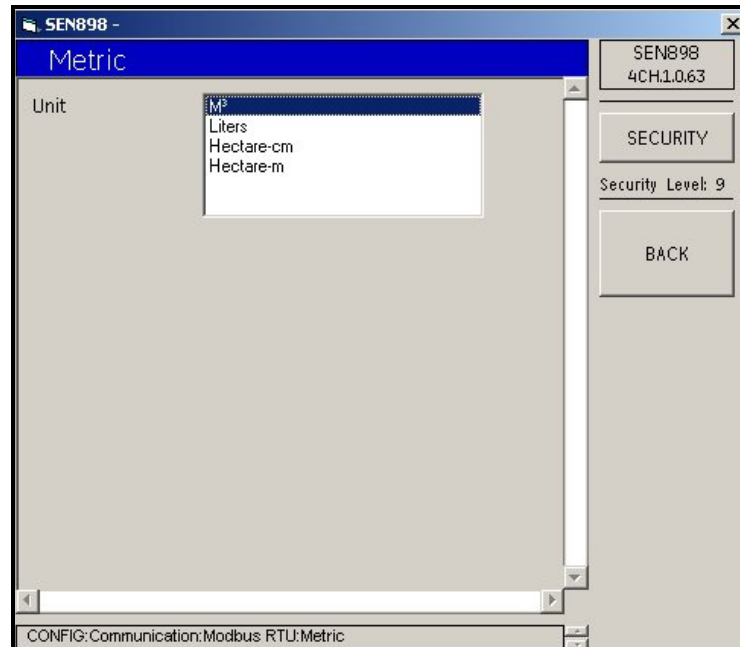

**Figure 136: Parity Menu**

12. Click twice on your selection, and the screen returns to the Modbus RTU menu.

### 5.8.2.1 Modbus (cont.)

13. To select units, click on Total Units. The following screen appears.



**Figure 137: Total Units Menu**

14. Click twice on your selection, and the screen returns to the Modbus RTU menu.

15. To select standard volumetric units, click on Volumetric. The following screen appears.

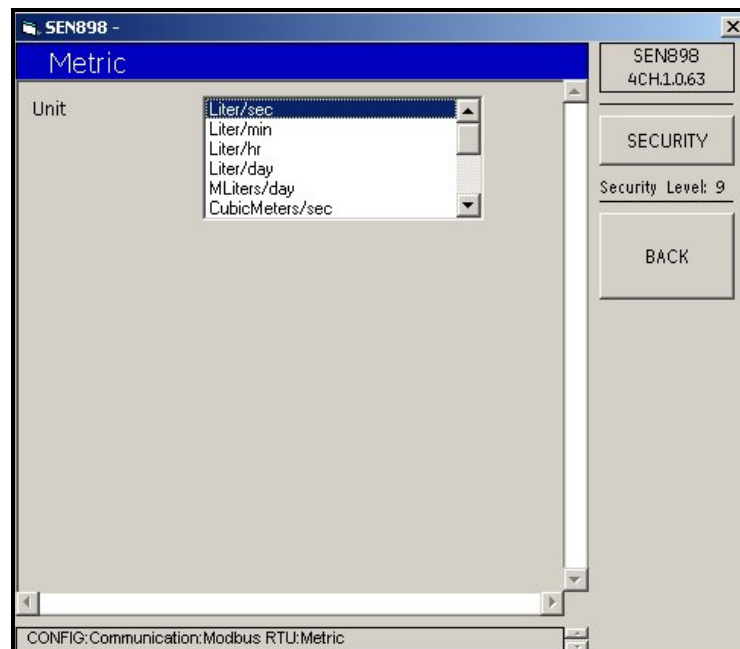

**Figure 138: Standard Volumetric Units Menu**

16. Click twice on your selection, and the screen returns to the Modbus RTU menu. Click on BACK to return to the Communication menu.

### 5.8.2.2 HART

1. To set up HART software, click on HART. The following screen appears.

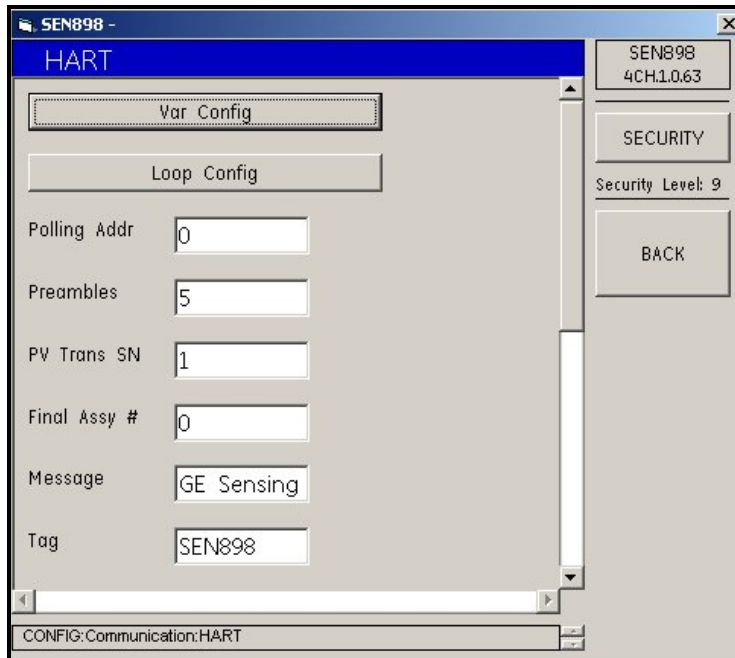

Figure 139: HART Menu

2. To set up HART variable configurations, click on Var Config, and the following screen appears.

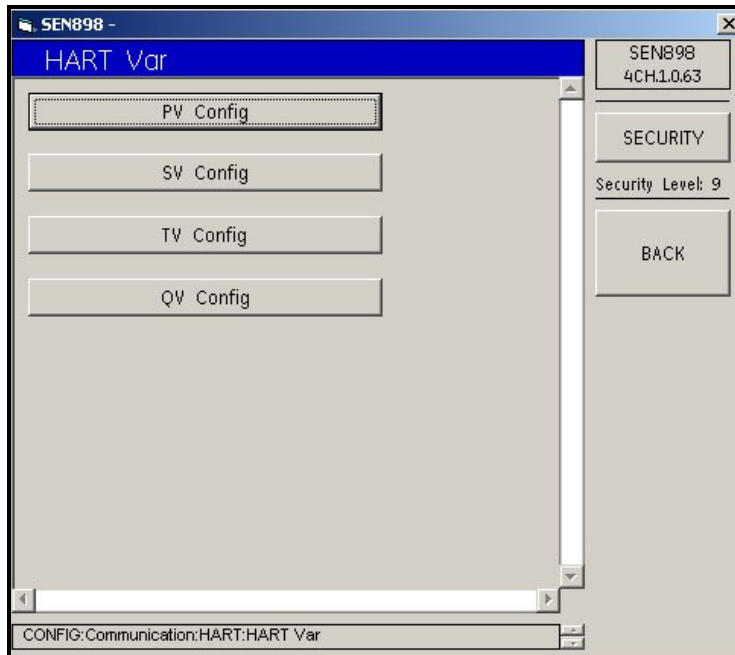

Figure 140: Hart Variable Configurations Menu

### 5.8.2.2 HART (cont.)

- Click on PV Config and the following screen appears.

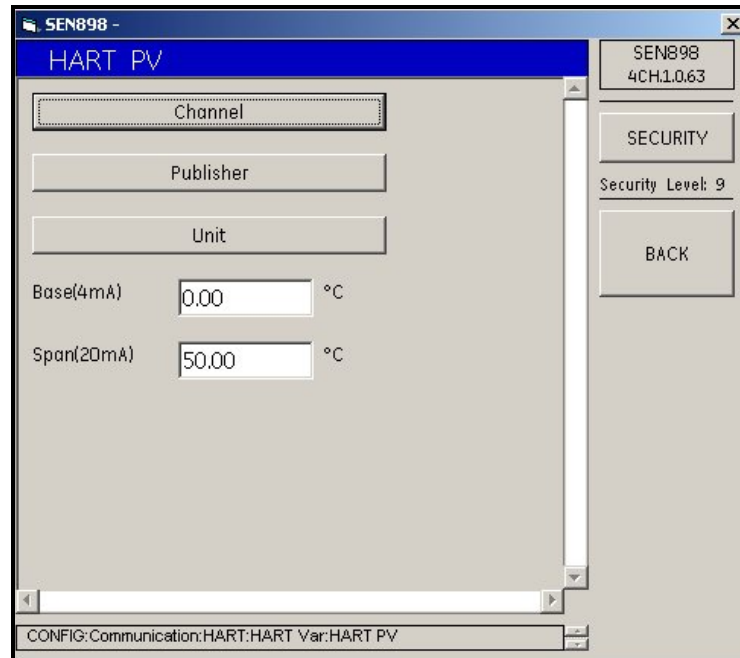

Figure 141: HART PV Configuration Menu

- To select a channel for the HART PV Communication, click on Channel. The following screen appears.

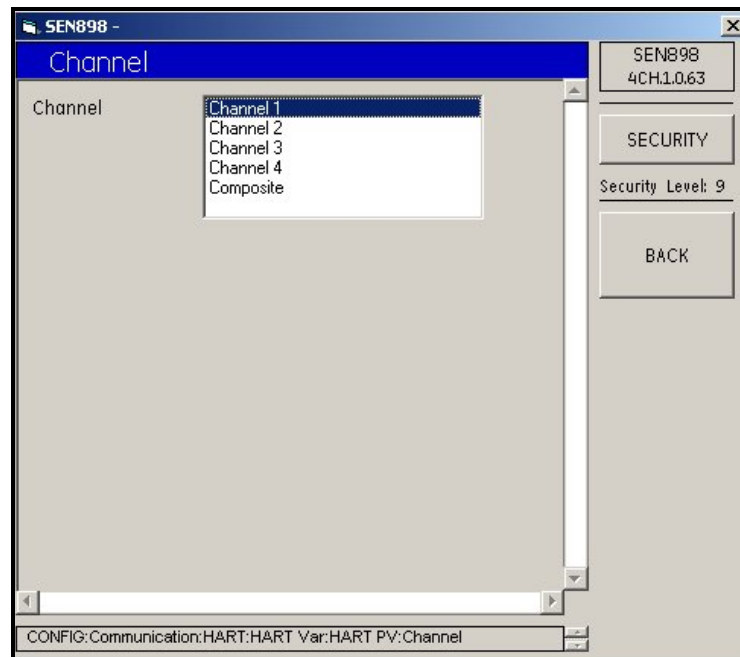

Figure 142: Channel Menu

### 5.8.2.2 HART (cont.)

5. Click twice on the desired channel and the screen returns to the HART PV menu.
6. Click on Publisher and/or Unit and make selections as above.
7. If required, from the HART PV menu, change the Base(4mA) and/or the Span(20mA) values. Enter the appropriate temperature value into the text box and click on BACK. Click Yes to confirm the change, or click No to reject it. Click on BACK to return to the HART Variables menu.
8. Make whatever changes are necessary to the SV, TV and/or QV Config menus as above, and click on BACK to return to the HART menu.
9. Click on Loop Config to turn the Loop Signaling and Fixed Mode, On or Off.
10. On the HART menu, to change listed information, enter the appropriate text into the text box and click on BACK. Click Yes to confirm the change, or click No to reject it. Click on BACK to return to the Communication screen.



### 5.8.3 Reset Totals

1. To confirm the changes made, from the CONFIG menu click on Reset Totals. The following screen appears.

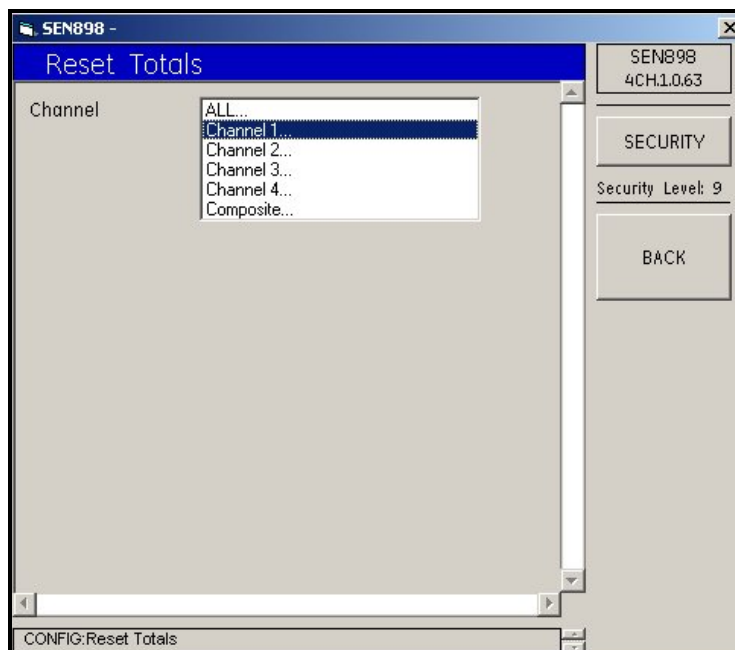

**Figure 143: Reset Totals Menu**

2. To set a location for the reset, click twice on ALL..., Channel X..., or Composite, and the following screen appears.

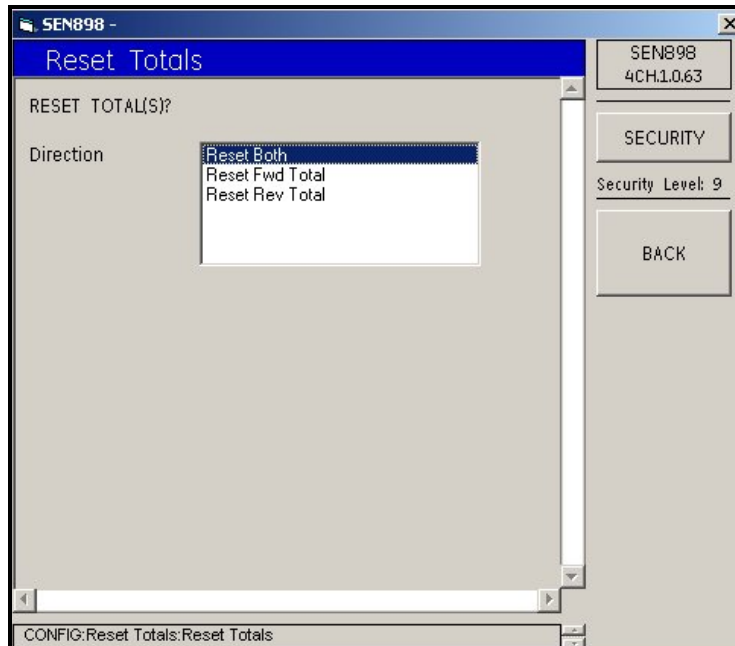
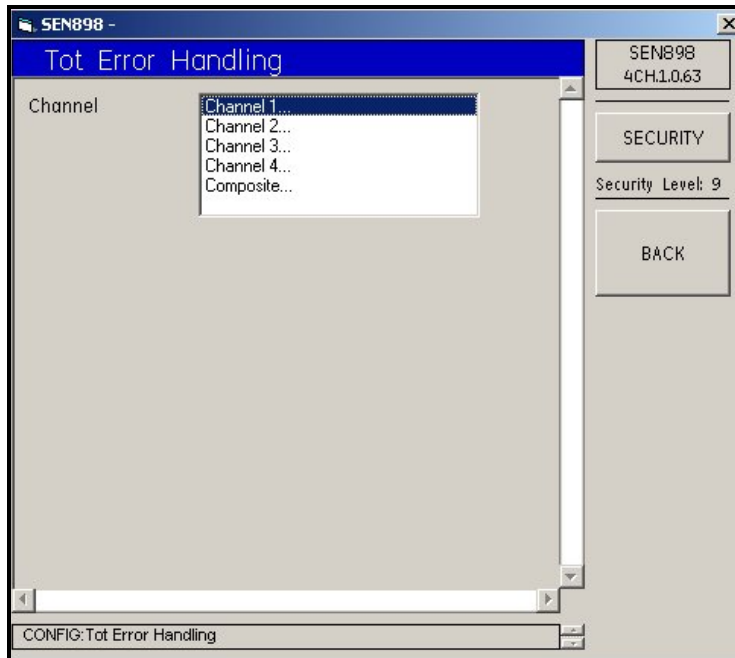

**Figure 144: Reset Direction Options**

3. Click twice on the Reset Totals Direction required, and the screen returns to the Reset Totals menu.
4. Repeat this process for another channel, if necessary. When complete, click on BACK, and the screen returns to the CONFIG menu.

### 5.8.4 Totalizer Errors

1. To set up totalizer error handling, click on Totalizer Errors, and the following screen appears.



**Figure 145: Totalizer Error Handling**

2. Click twice on the appropriate channel, and the following screen appears.

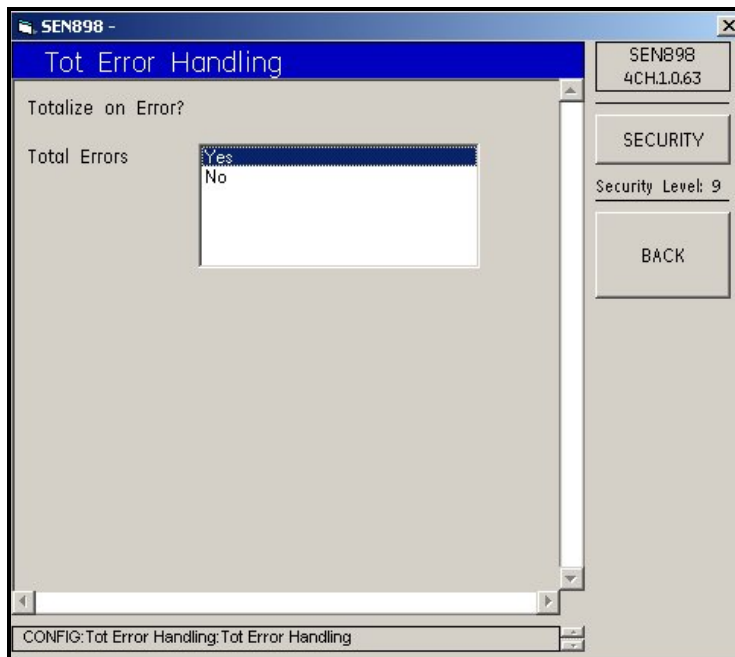

**Figure 146: Confirming Totalizer Error Handling**

3. Click twice on Yes to confirm the selection above, or No to reject it. Click on BACK to return to the original CONFIG menu. Exit the original CONFIG menu by clicking the X in the upper right hand corner of the screen.

## 5.9 Input/Output Menu

- To set up the inputs and outputs, under the meter name, click twice on IO Menu and the following screen appears.

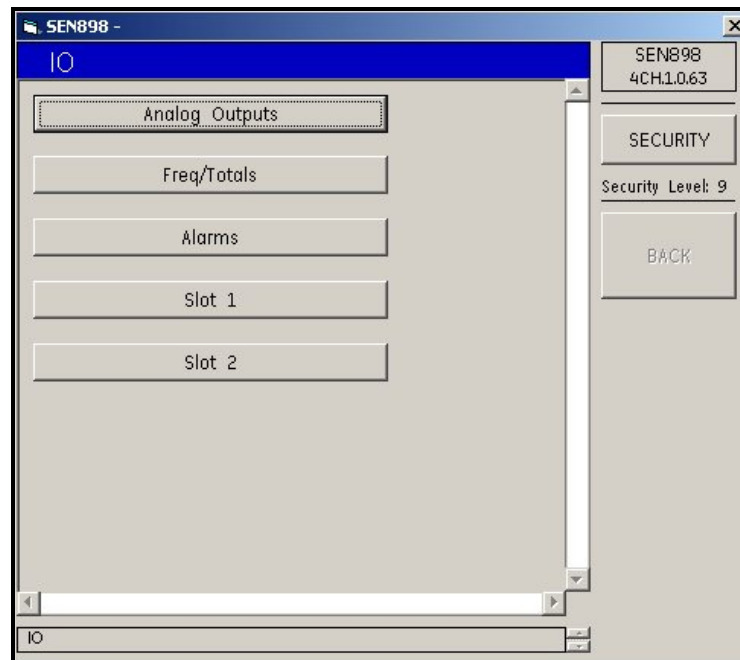

Figure 147: Input/Output Menu

### 5.9.1 Analog Outputs Setup

- Click on Analog Outputs, and the following screen appears.

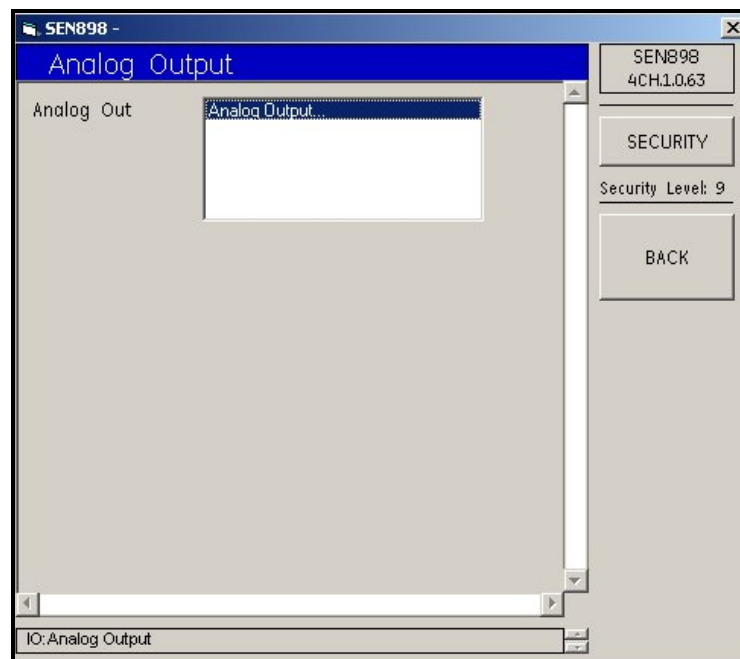

Figure 148: Analog Output Option

### 5.9.1 Analog Outputs Setup (cont.)

- Click twice on Analog Outputs and the following screen appears.

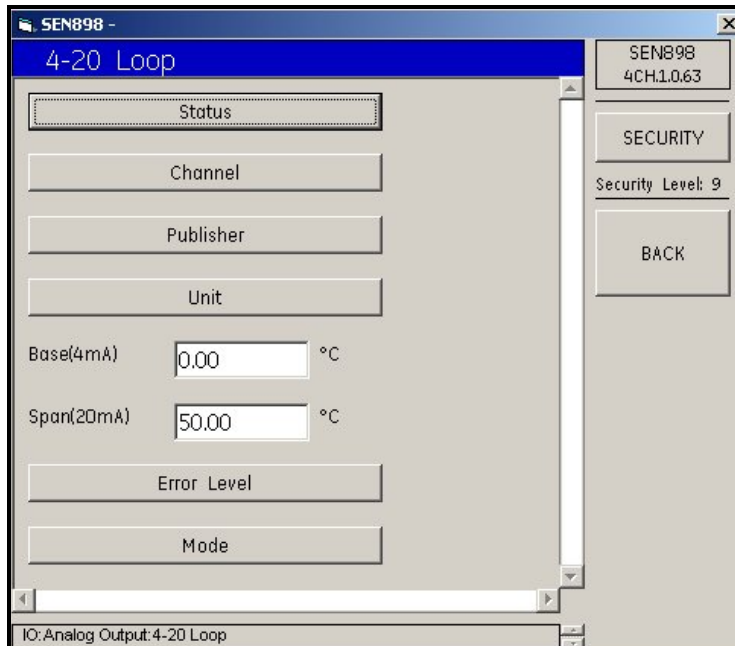

Figure 149: 4-20 Loop Menu

- Click on Status and the following screen appears.

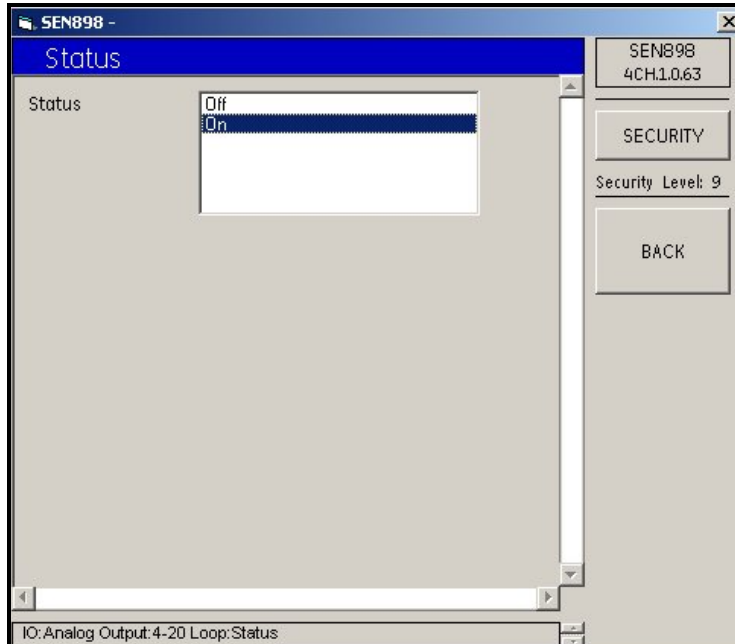

Figure 150: 4-20 Loop Status

- Click On or Off twice and the screen returns to the 4-20 Loop menu.
- Repeat this procedure for each option on the 4-20 Loop menu. Change the Base(4mA) and Span(20mA) text box readings (if required). Confirm the new entries by clicking Yes on the Verification screens, and click BACK twice.

## 5.9.2 Frequency/Totals Setup

- From the IO (Input/Output) menu, click on Freq/Totals. The following screen appears.

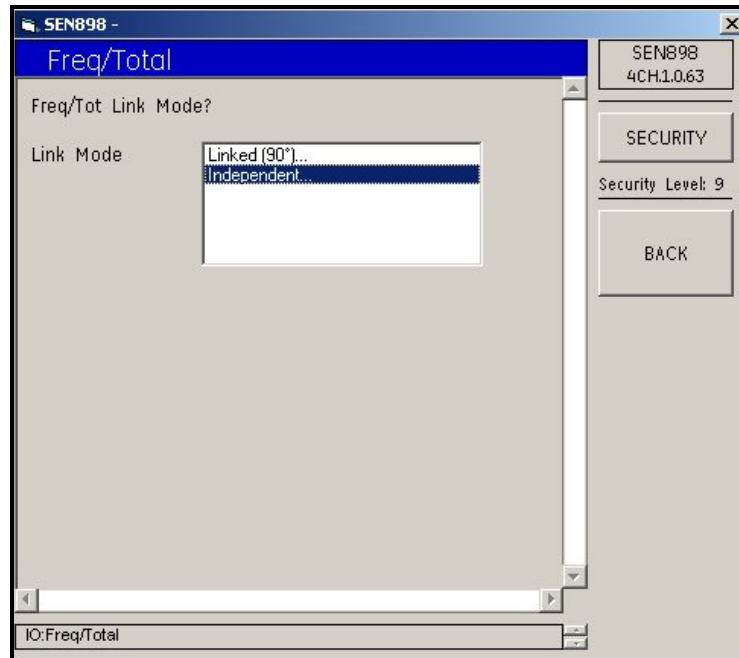

Figure 151: Frequency/Total Link Mode

- Click twice on the required Link Mode description, and the following screen appears.

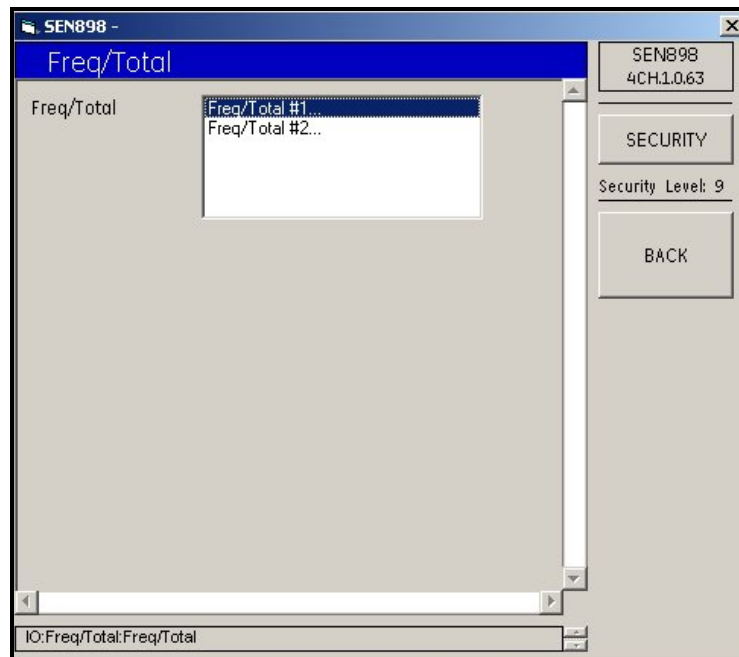

Figure 152: Frequency/Total Number

**Note:** The Linked (90°)... has only one Freq/Total option, while the Independent... has two.

## 5.9.2 Frequency/Totals Setup (cont.)

- Click twice on the appropriate Freq/Total #, and the following screen appears.

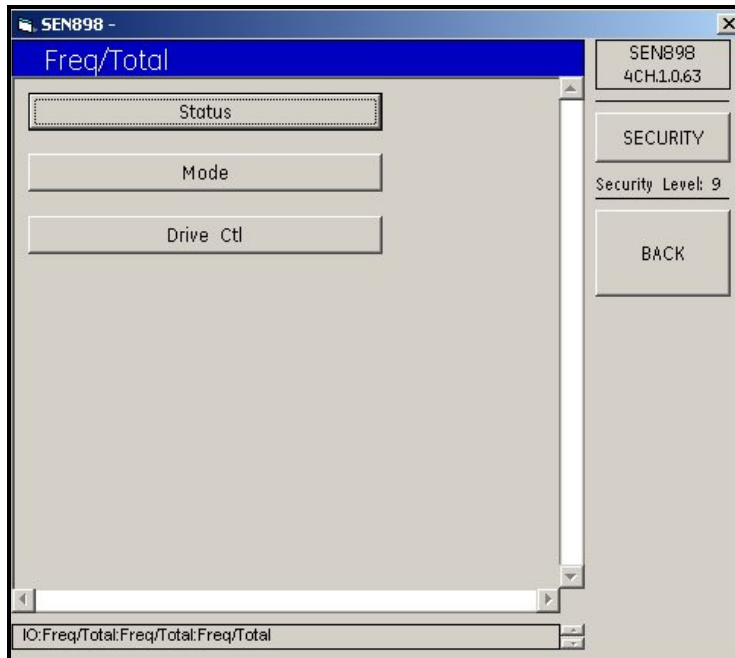

Figure 153: Frequency/Total Options

- Click on Status, and the following screen appears.

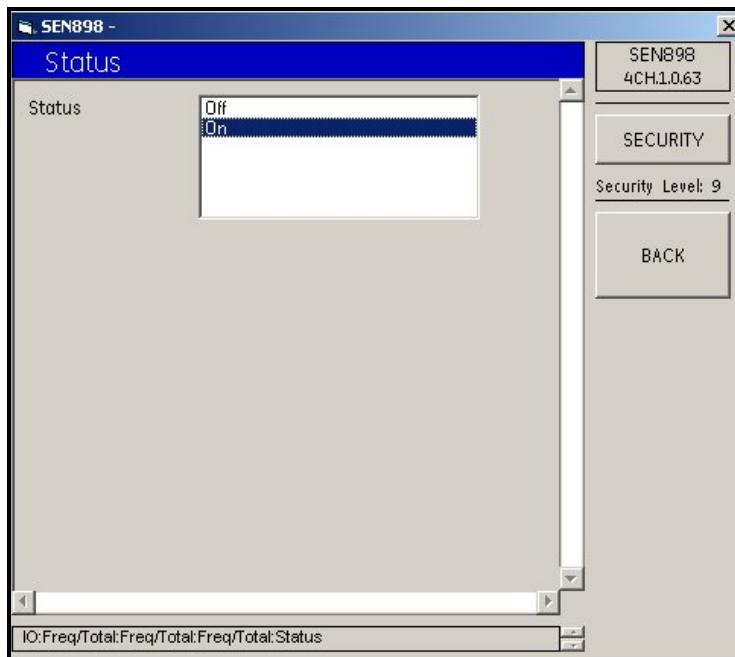
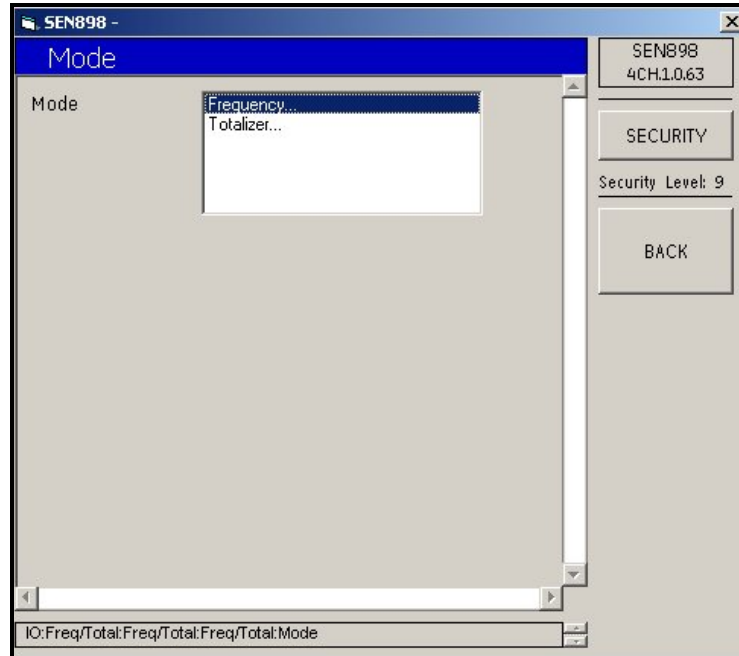

Figure 154: Frequency/Total Status

- Click twice on the appropriate Status option, and the screen returns to the Freq/Total options

## 5.9.2 Frequency/Totals Setup (cont.)

- Click on Mode, and the following screen appears.



**Figure 155: Frequency/Total Mode Options**

- Click twice on the Frequency... option, and the following screen appears.

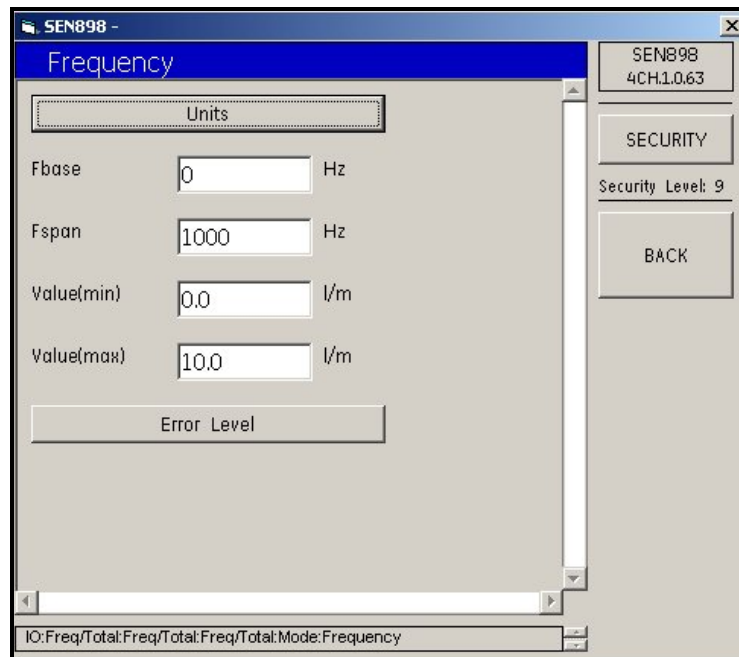

**Figure 156: Frequency Menu**

## 5.9.2 Frequency/Totals Setup (cont.)

- Click on Units, and the following screen appears.

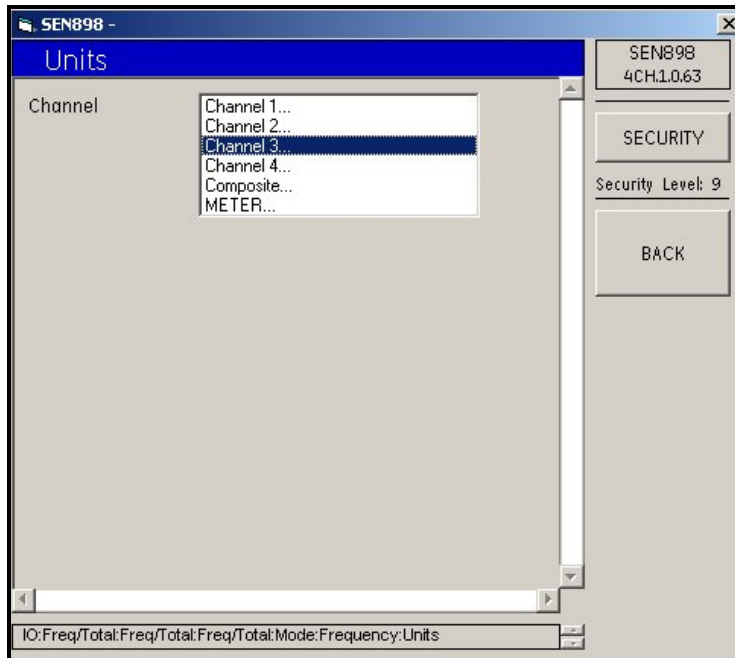

**Figure 157: Channel Options**

- Click twice on the appropriate Channel, and the following screen appears.

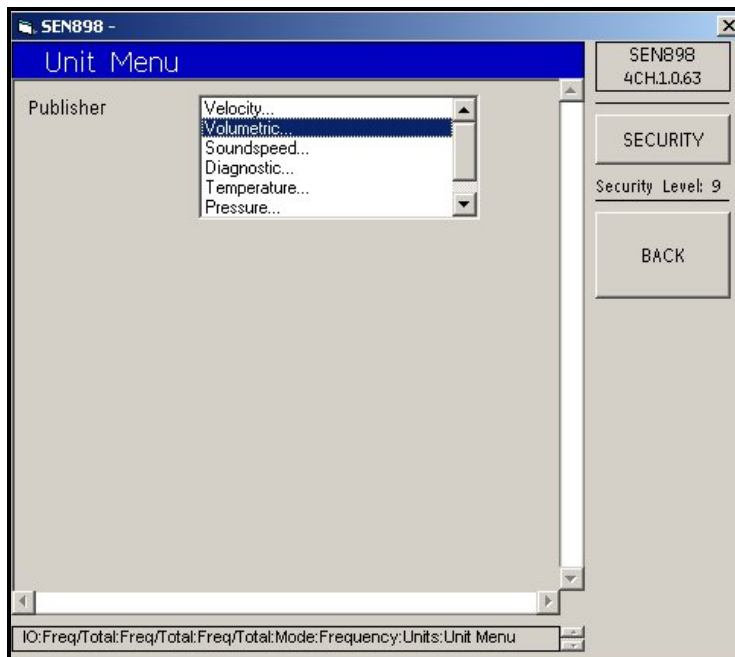

**Figure 158: Publisher Options**



### 5.9.2 Frequency/Totals Setup (cont.)

10. Click twice on the appropriate Publisher, and the following screen appears.

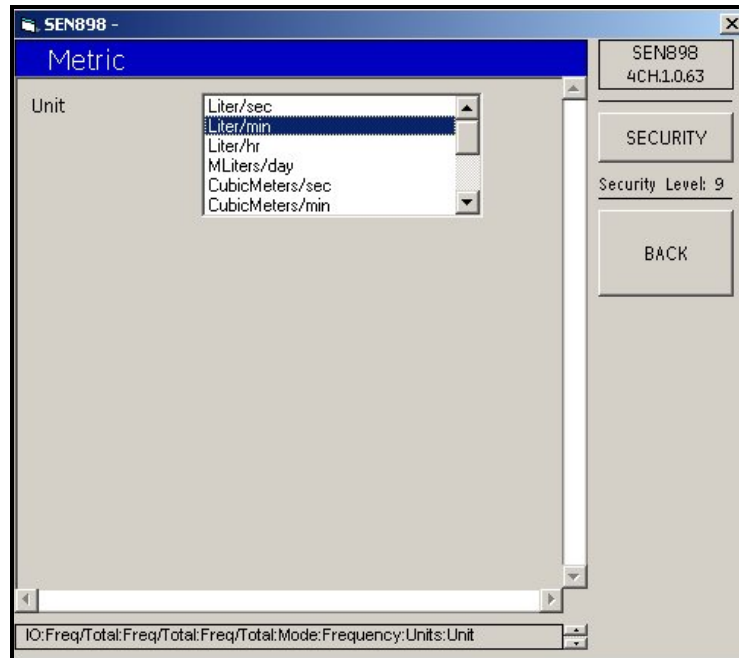

Figure 159: Unit Options

11. Click twice on the appropriate Unit option, and click on BACK until the Frequency menu appears. Click on Error Level and the following screen appears.

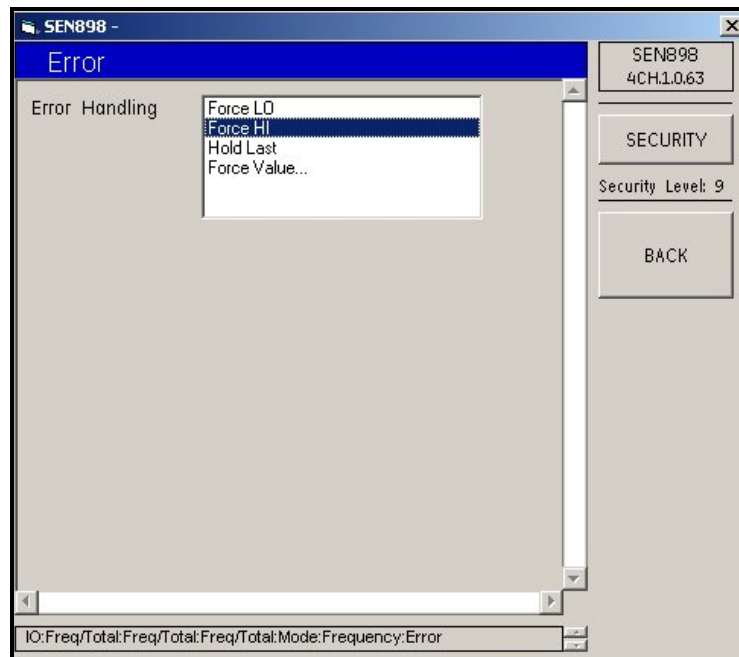

Figure 160: Error Handling Options

12. Click twice on the appropriate Error Handling description, and the screen returns to the Frequency menu.

## 5.9.2 Frequency/Totals Setup (cont.)

13. Under the Mode menu, click twice on Totalizer..., and the following screen appears.

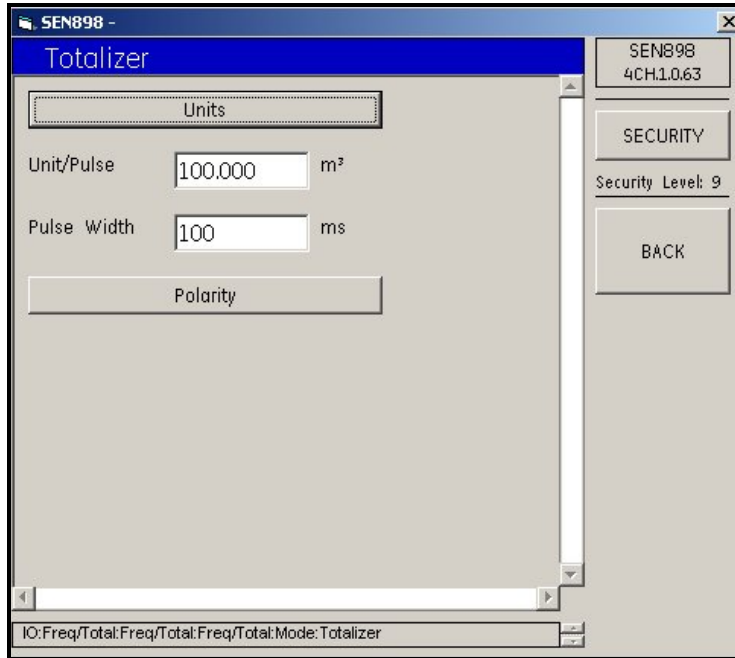

Figure 161: Totalizer Menu

14. Click on Units, and the following screen appears.

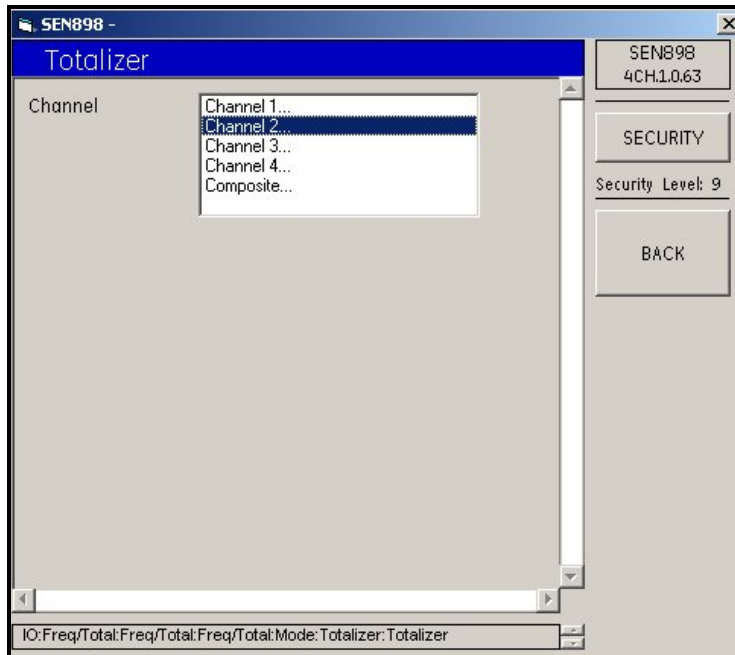
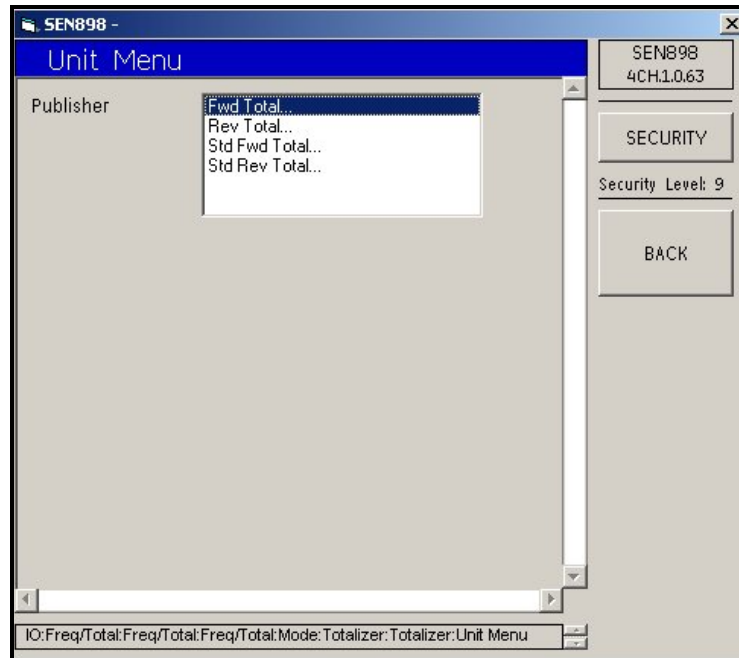

Figure 162: Totalizer Channel Options

### 5.9.2 Frequency/Totals Setup (cont.)

15. Click twice on the appropriate Channel, and the following screen appears.



**Figure 163: Publisher Options**

16. Click twice on the appropriate Publisher option, and the following screen appears.

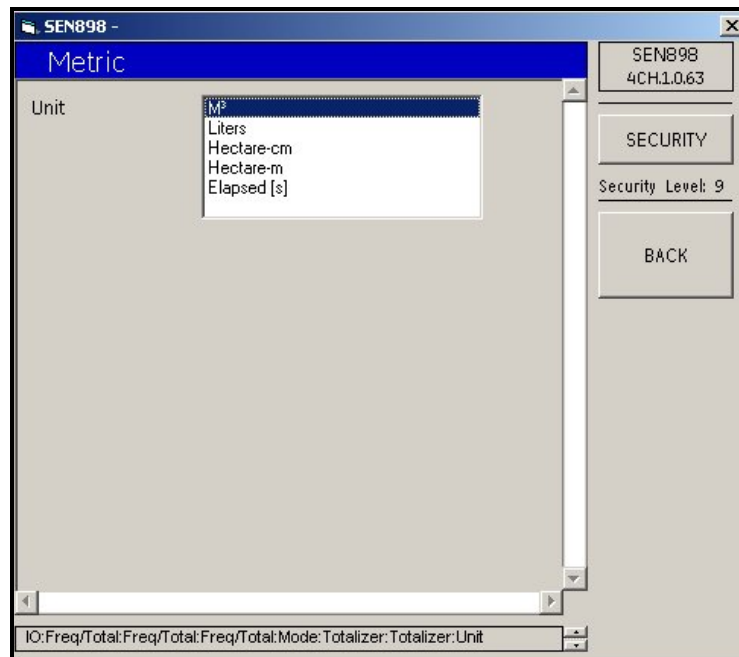

**Figure 164: Unit Options**

17. Click twice on the appropriate measurement Unit, and use the BACK button to return to the Totalizer menu.

## 5.9.2 Frequency/Totals Setup (cont.)

18. From the Totalizer menu, click on Polarity, and the following screen appears.

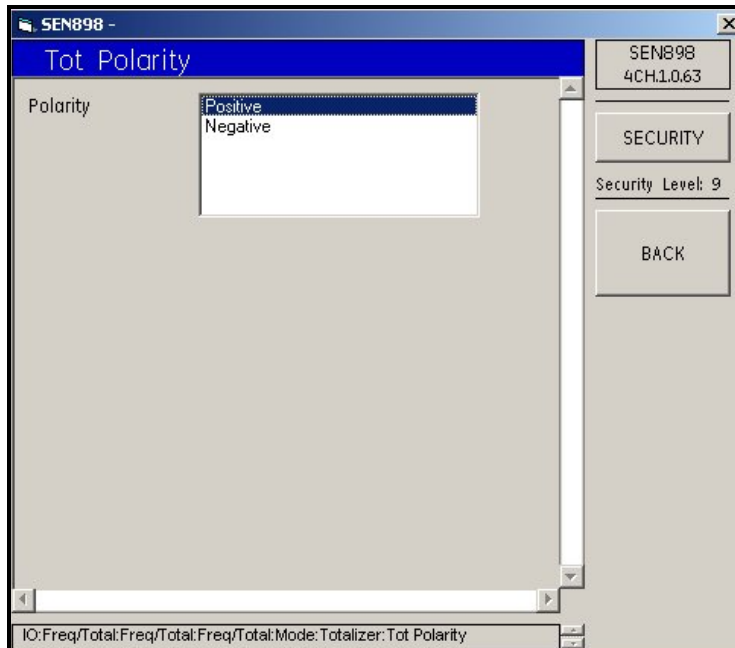

Figure 165: Polarity Options

19. Click twice on the appropriate Polarity option, and the screen returns to the Totalizer menu.

20. Change the Unit/Pulse and/or Pulse Width text box readings (if required). Confirm the new entries by clicking Yes on the Verification screens, and click BACK twice.

21. From the Freq/Total menu, click on Drive Ctl. The following screen appears.

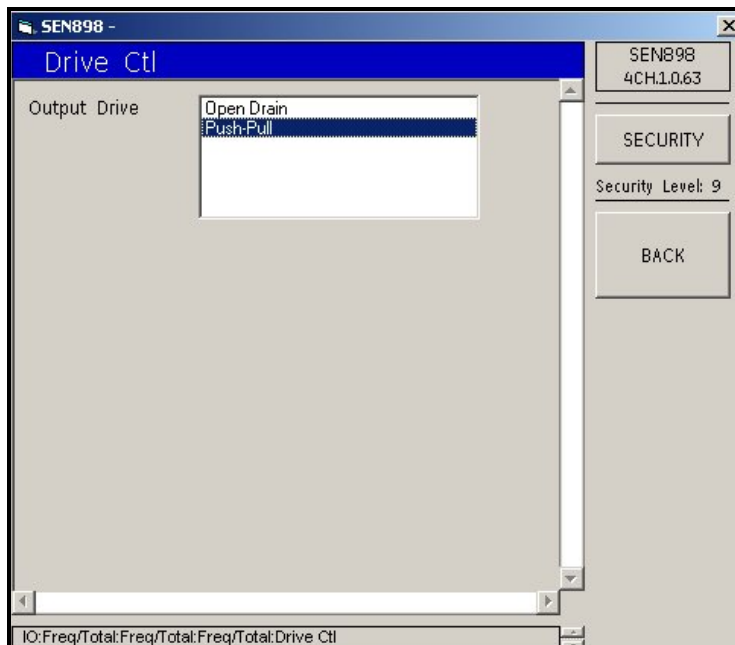

Figure 166: Output Drive Options

22. Click twice on the appropriate Output Drive description, and the screen returns to the Freq/Total menu. Click on BACK three times to return to the IO (Input/Output) menu.

### 5.9.3 Alarms Setup

1. Click on Alarms and the following screen appears.

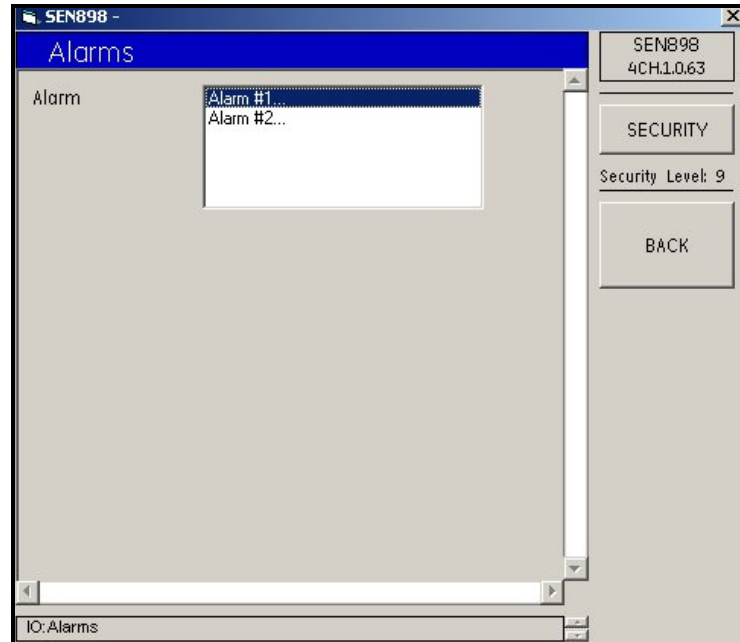

Figure 167: Alarm Options

2. Click twice on the appropriate Alarm #, and the following screen appears.

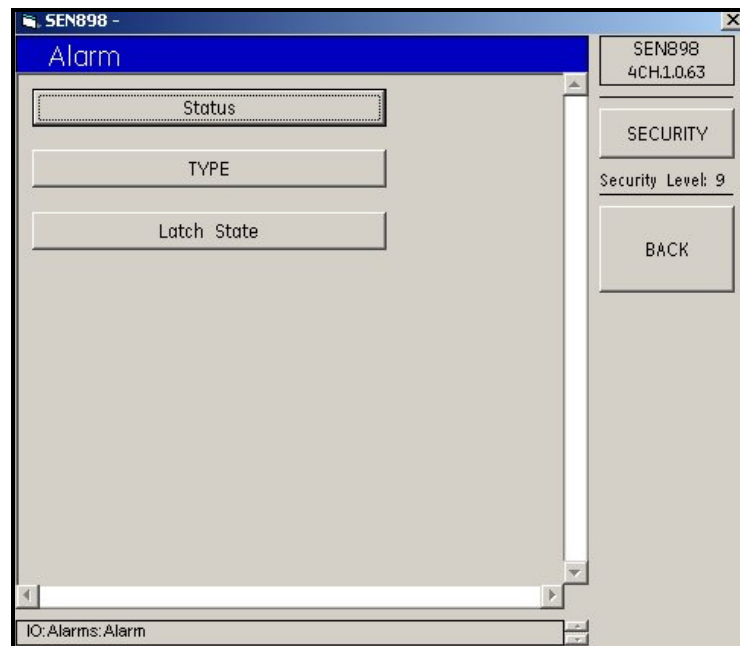

Figure 168: Alarm Menu

### 5.9.3 Alarms Setup (cont.)

3. Click on Status, and the following screen appears.

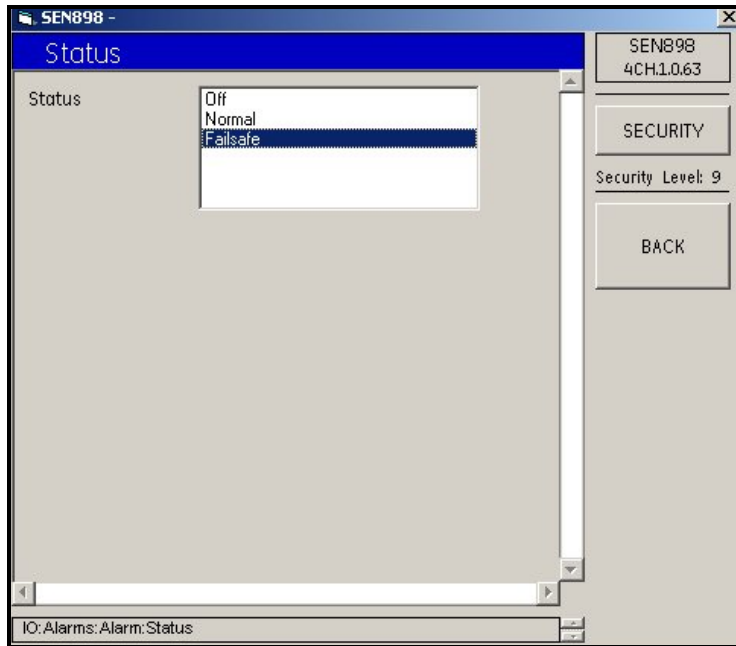

Figure 169: Alarm Status Options

4. Click twice on the appropriate Status option, and the screen returns to the Alarm menu.

5. Click on TYPE and the following screen appears.

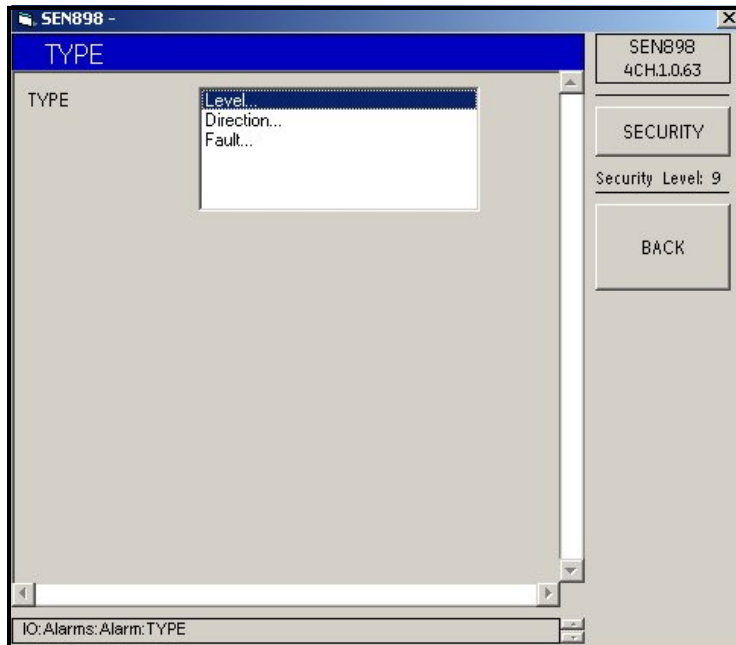

Figure 170: Alarm Type Options

### 5.9.3 Alarms Setup (cont.)

- Click twice on Level... and the following screen appears.

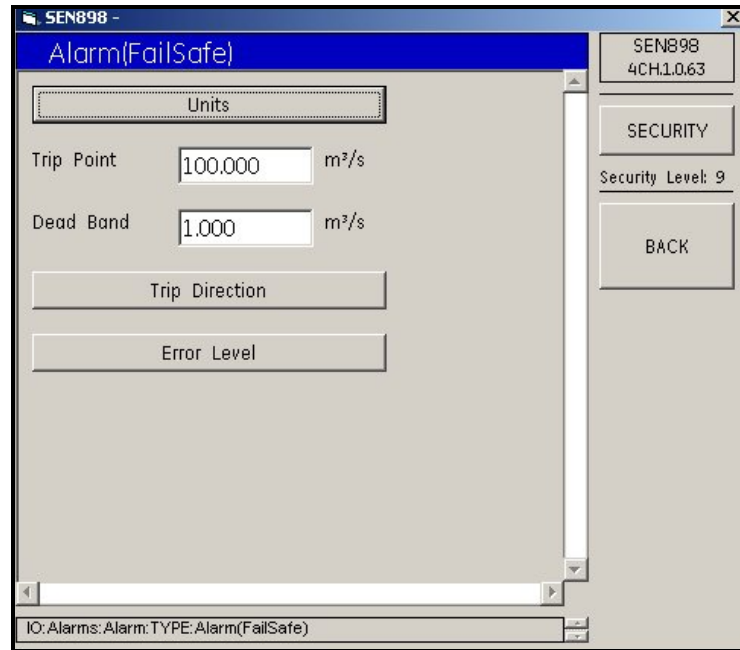

Figure 171: Alarm (Fail-safe) Menu

- Click on Units, and the following screen appears.

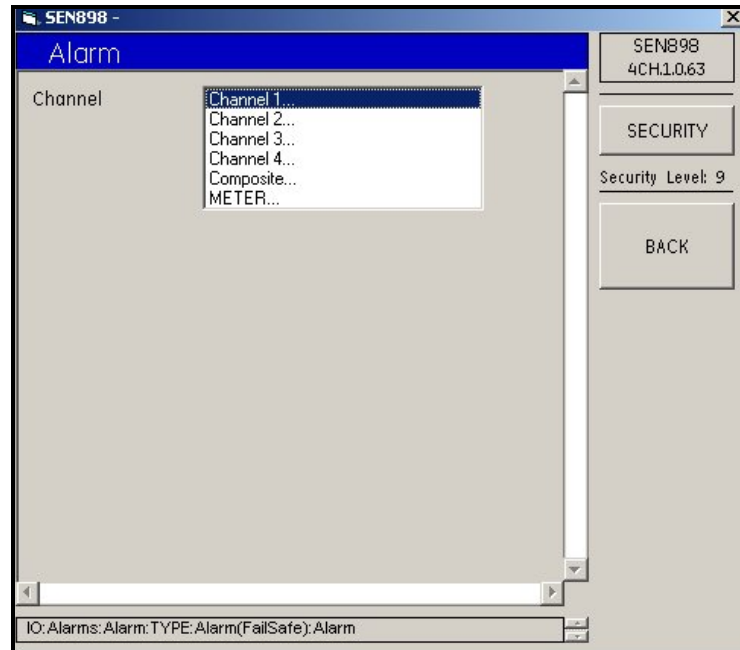
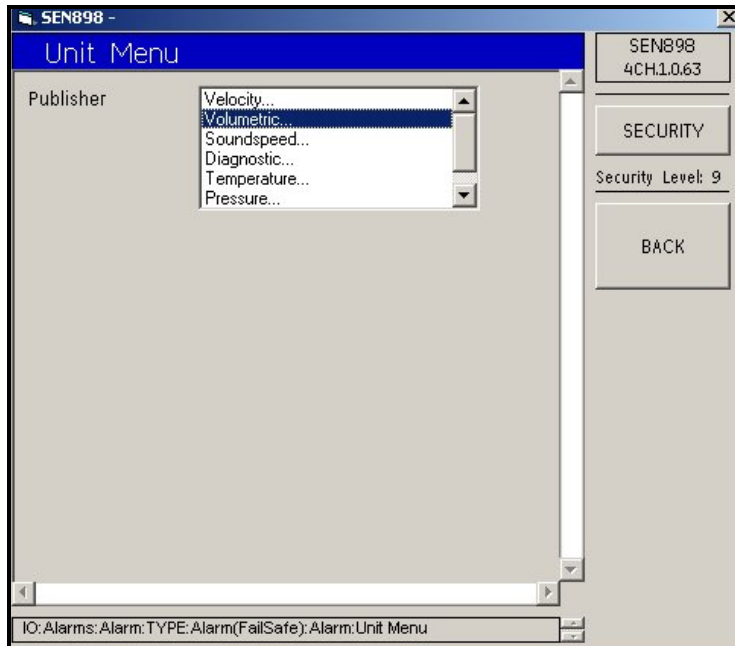

Figure 172: Alarm Channel Options

### 5.9.3 Alarms Setup (cont.)

8. Click twice on the appropriate Channel, and the following screen appears.



**Figure 173: Alarm Measurement Type Options**

9. Click twice on the appropriate measurement type, and the following screen appears.

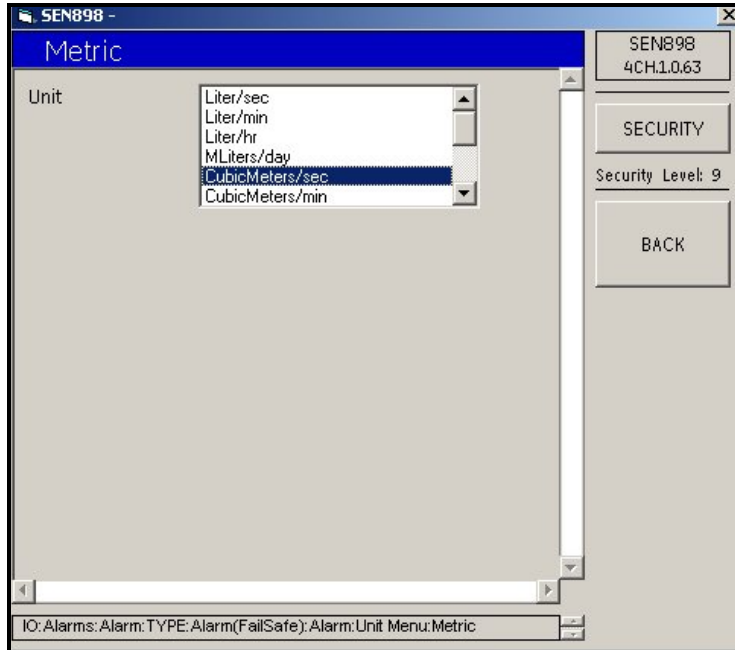

**Figure 174: Alarm Measurement Unit Options**

10. Click twice on the appropriate unit type, and the previous screen appears. Click on BACK twice to return to the Alarm(FailSafe) menu.



### 5.9.3 Alarms Setup (cont.)

11. From the Alarm(FailSafe) menu, click on Trip Direction. The following screen appears.

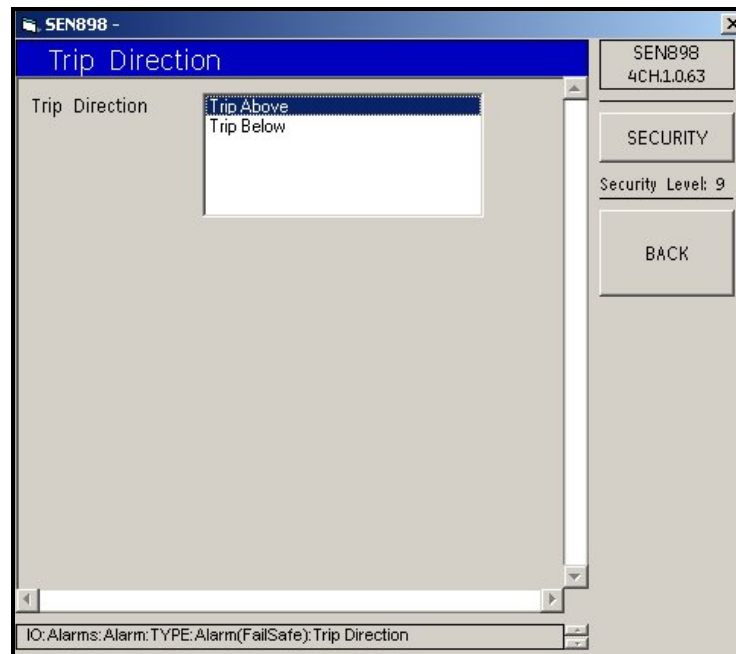

**Figure 175: Alarm Trip Direction Options**

12. Click twice on the appropriate Trip Direction, and the screen returns to the Alarm(FailSafe) menu.
13. Click on Error Level, and the following screen appears.

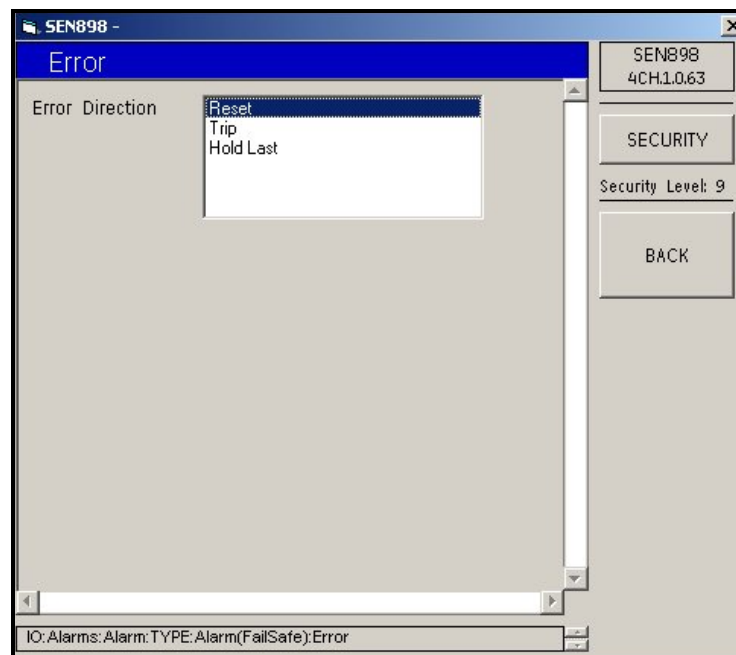

**Figure 176: Alarm Error Direction Options**

14. Click twice on the appropriate Error Direction, and the screen returns to the Alarm(FailSafe) menu.

### 5.9.3 Alarms Setup (cont.)

15. From the Alarm(FailSafe) menu, change the Trip Point and/or Dead Band text box readings (if required) and click on BACK. Confirm the new entries by clicking Yes on the Verification screens.
16. To set up the alarm direction, from the Alarm Type Options menu (see Figure 170 on page 138), click twice on Direction... The following screen appears.

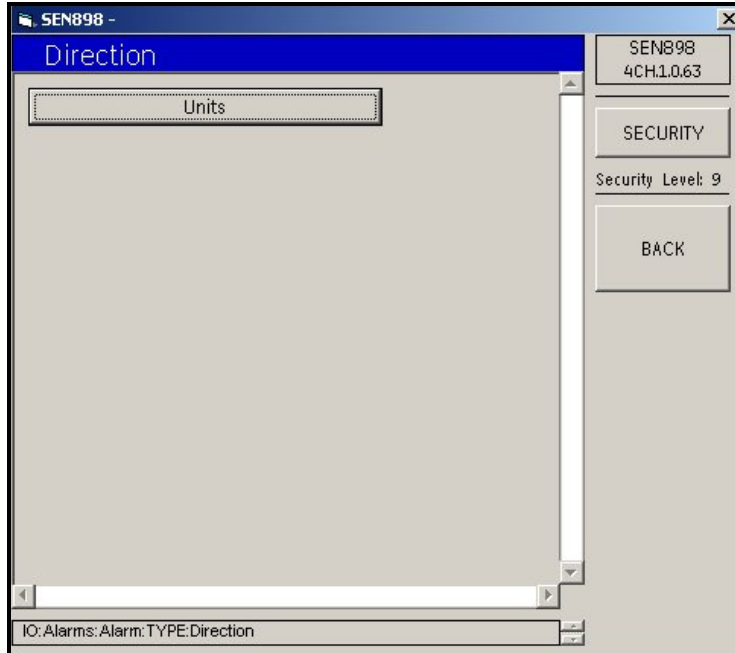

Figure 177: Alarm Trip Direction Menu

17. Click on Units and the following screen appears.

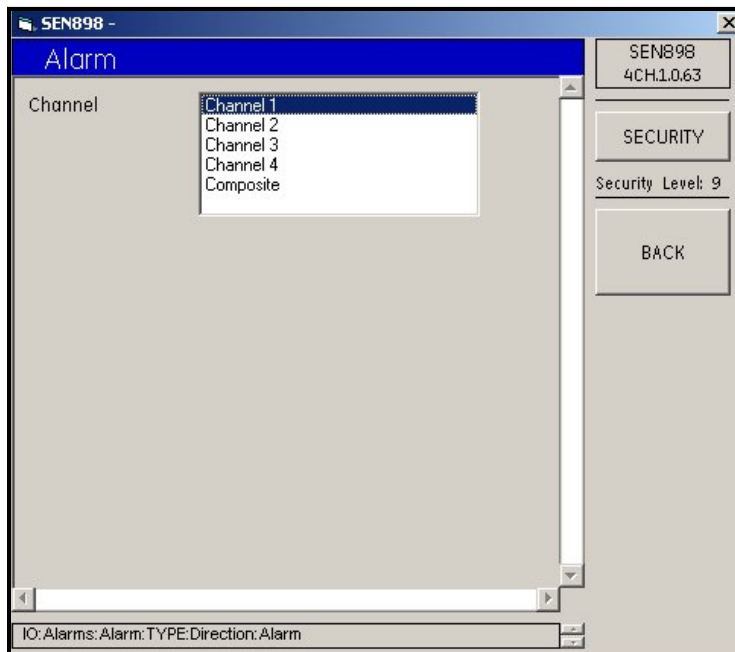

Figure 178: Alarm Trip Direction Channel Options

### 5.9.3 Alarms Setup (cont.)

18. Click twice on the appropriate channel, and the screen returns to the Trip Direction menu. Click on BACK to return to the Alarm Type Options menu.
19. From the Alarm Type Options menu, click twice on Fault..., and the following screen appears.

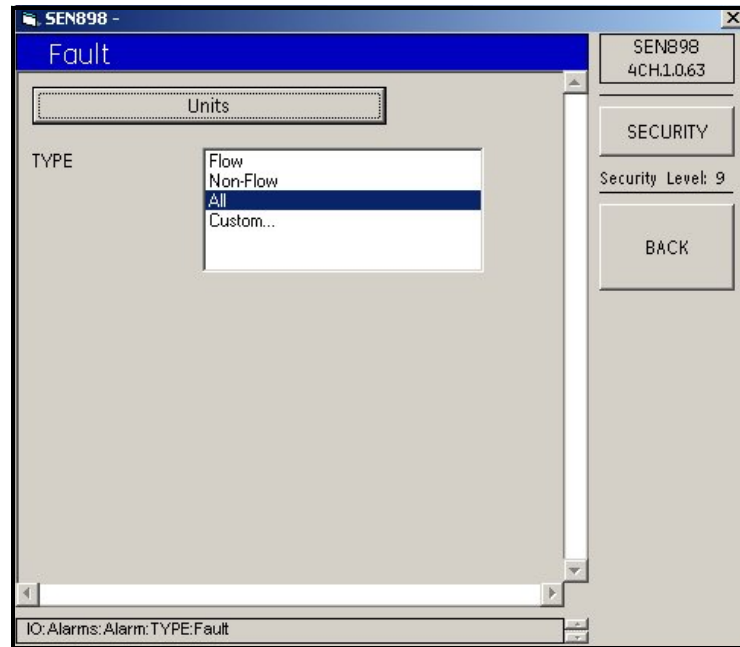

Figure 179: Alarm Fault Type Options

20. Click on Units, and the following screen appears.

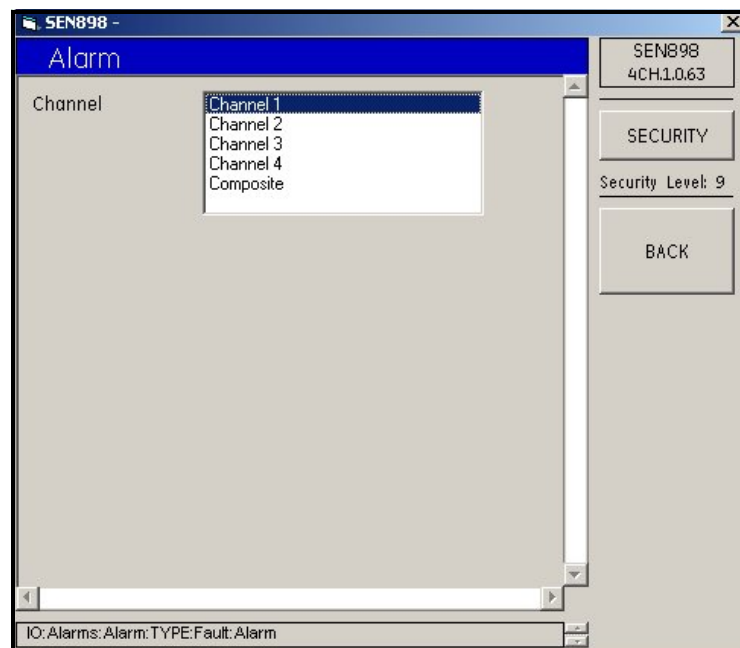

Figure 180: Alarm Fault Channel Options

21. Click twice on the appropriate Channel, and the screen returns to the previous screen.

### 5.9.3 Alarms Setup (cont.)

22. From the Alarm Fault Type Options screen, click twice on the appropriate type. If Flow, Non-Flow or All is selected, the screen returns to the Alarm Type Options screen. If Custom... is selected, the following screen appears.

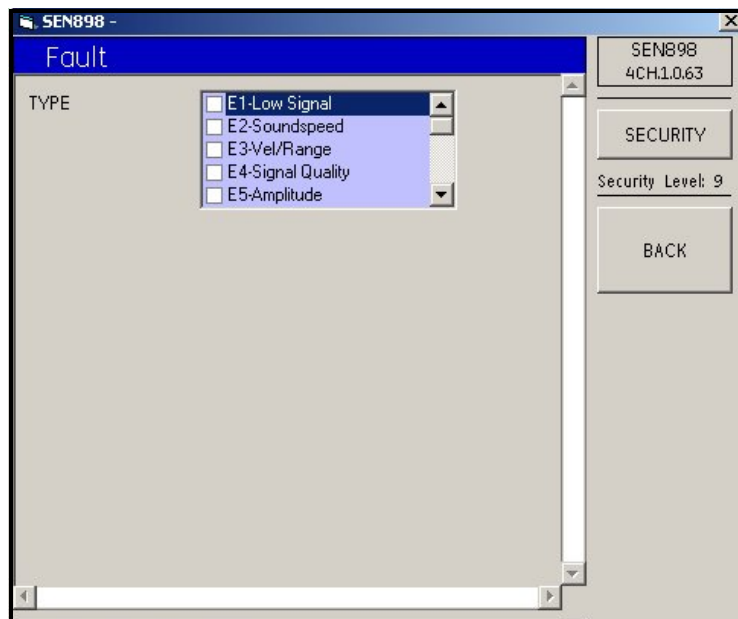

Figure 181: Alarm Fault Custom Types

23. Wait a few seconds for the window text to clear, then click in the white box to the left of the each appropriate fault type. A check mark appears after each click. To unselect a fault type, click on the specific check mark and the mark disappears. When all selections have been made, click on BACK three times to return to the Alarm Menu.

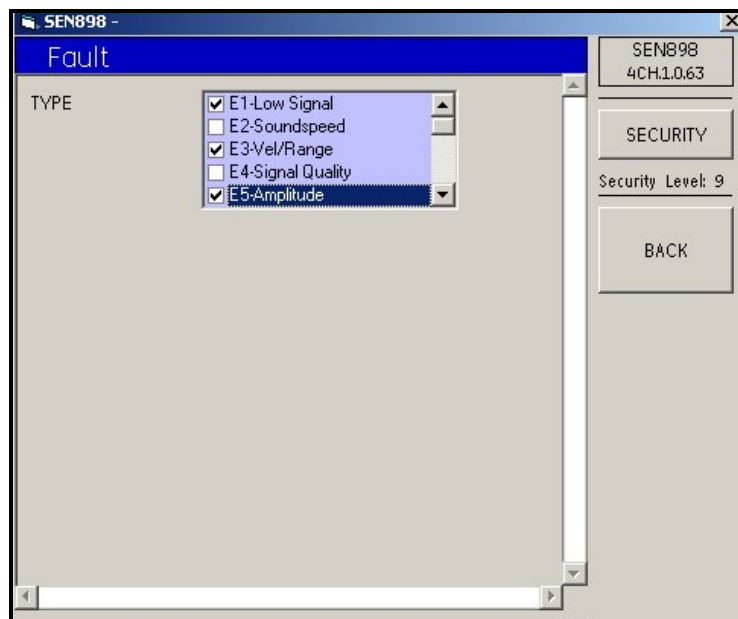
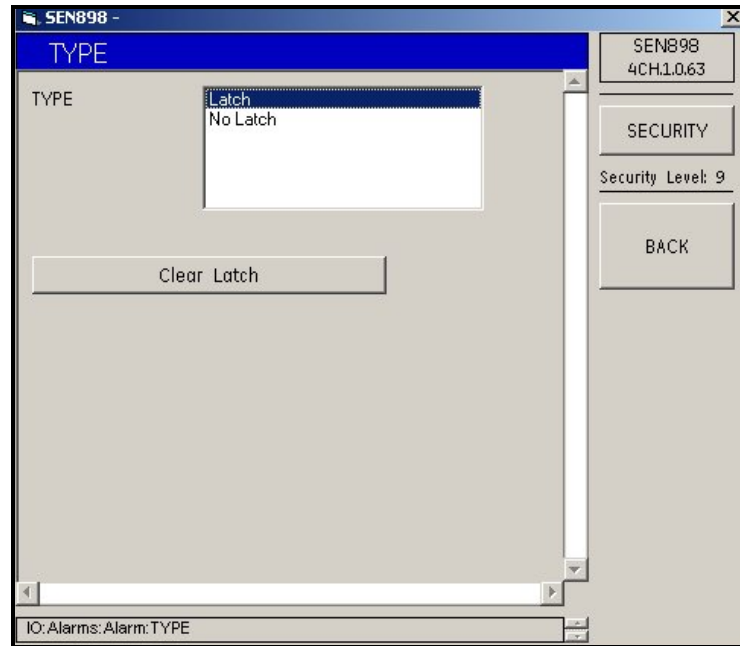

Figure 182: Custom Types Selected

### 5.9.3 Alarms Setup (cont.)

24. From the Alarm Menu, click on Latch State and the following screen appears.



**Figure 183: Alarm Latch Options**

25. Click twice on Latch or No Latch, and the screen returns to the Alarm Menu. If a latch already exists and needs to be removed, click on Clear Latch and the following screen appears.

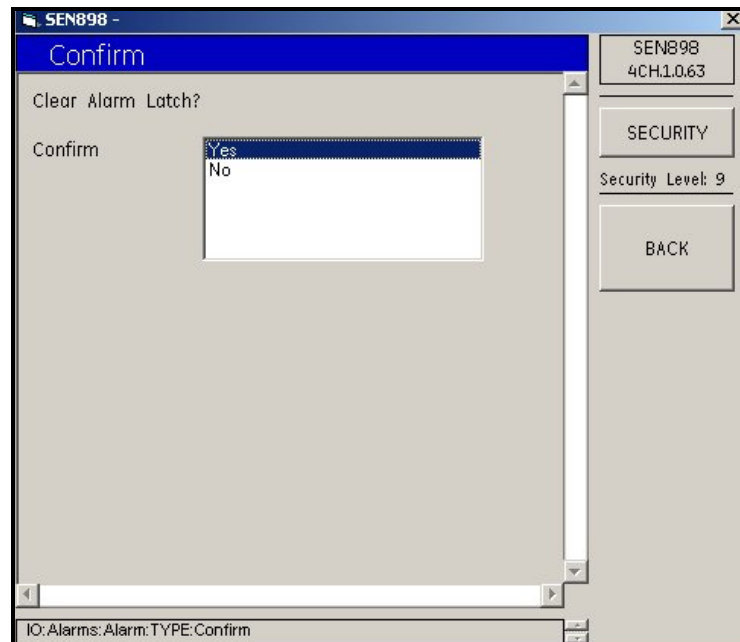

**Figure 184: Clear Alarm Latch Confirmation**

26. Click twice on Yes to remove the latch, or No to keep the latch, and the screen returns to Alarm Latch Options. Use the BACK key to return to the IO (Input/Output) menu.

## 5.9.4 Slot 1 Setup

### 5.9.4.1 Analog Input Card

1. From the IO (Input/Output) menu, click on Slot 1. The following screen appears.

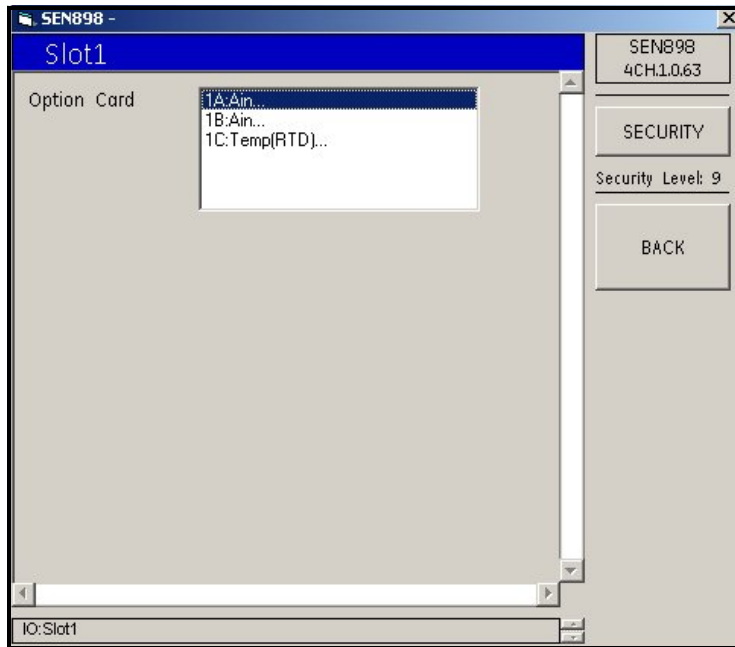

Figure 185: Slot 1 Options

2. Assign an Option Card to Slot 1 by clicking twice on the appropriate item. If an analog input card was selected, the following screen appears.

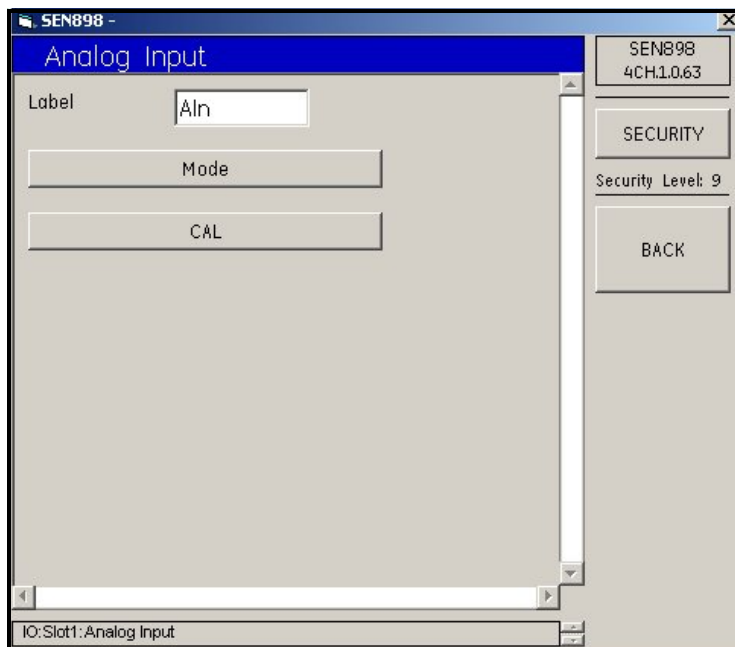
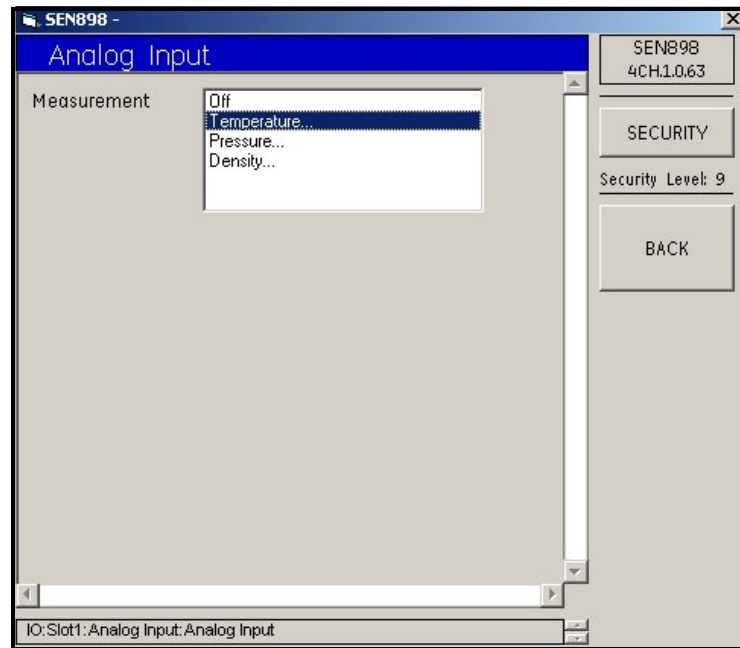

Figure 186: Analog Input Menu

### 5.9.4.1 Analog Input Card (cont.)

3. To change the card label, enter the new name into the text box, click on BACK, and click Yes on the Verification screen to complete the choice.
4. Click on Mode, and the following screen appears.



**Figure 187: Analog Input Measurement Options**

5. Choose the appropriate Measurement option and click on it twice. If Off is selected, the Measurement is turned off, and the screen returns to the Analog Input Card Menu. If Temperature... is selected, the following screen appears.

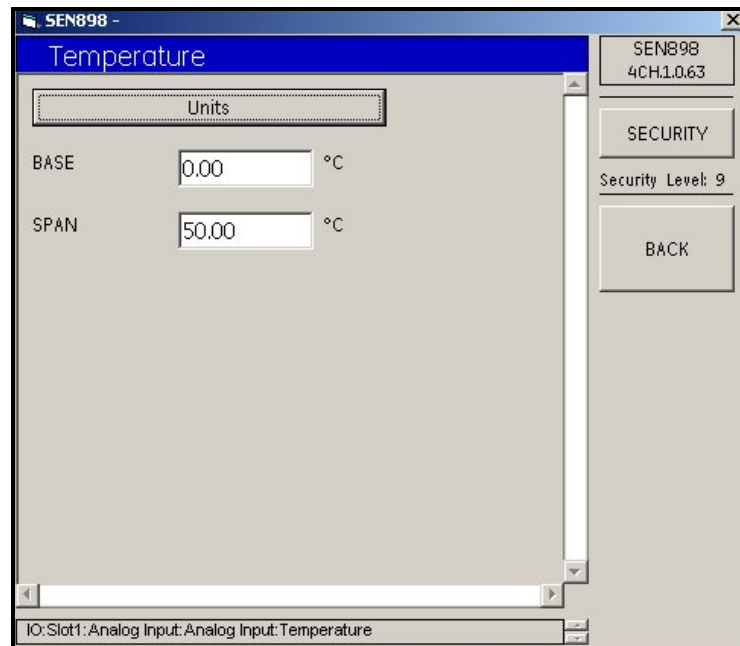

**Figure 188: Temperature Menu**

### 5.9.4.1 Analog Input Card (cont.)

6. Click on Units, and the following screen appears.

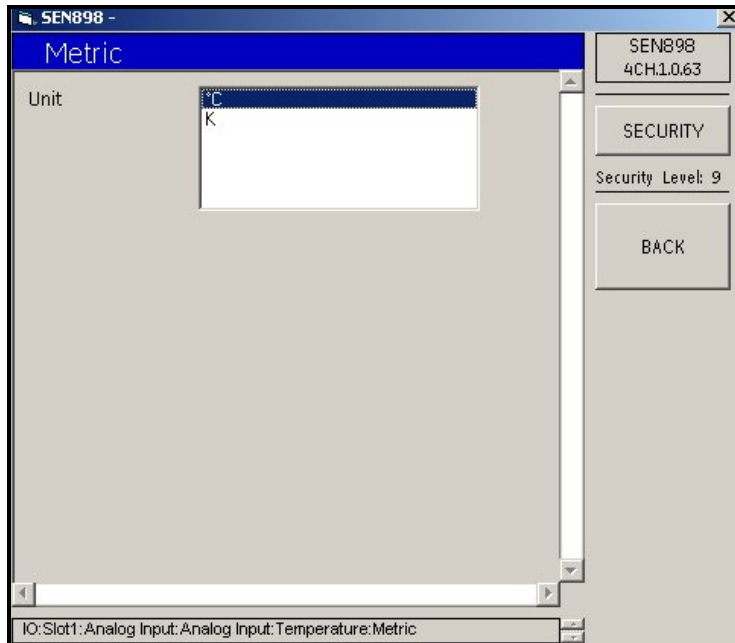

**Figure 189: Temperature Unit Options**

7. Click twice on the appropriate Unit, and the screen returns to the Temperature Menu.
8. If the BASE and/or SPAN temperature needs to be changed, enter the measurement into the text box, click on BACK, and confirm the change by clicking Yes on the Verification screen.
9. Return to the Analog Input Measurement Options menu, and repeat Steps 5 through 8 for Pressure... and Density... Then click on BACK and return to the Analog Input menu.



### 5.9.4.1 Analog Input Card (cont.)

10. To calibrate the Analog Input, click on CAL, and the following screen appears.

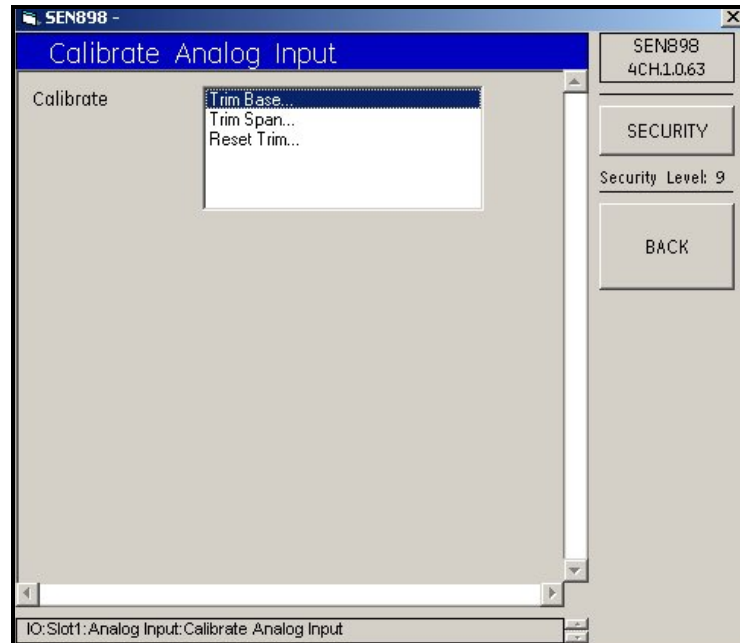

**Figure 190: Analog Input Calibration Options**

11. Click twice on Trim Base..., and the following screen appears.

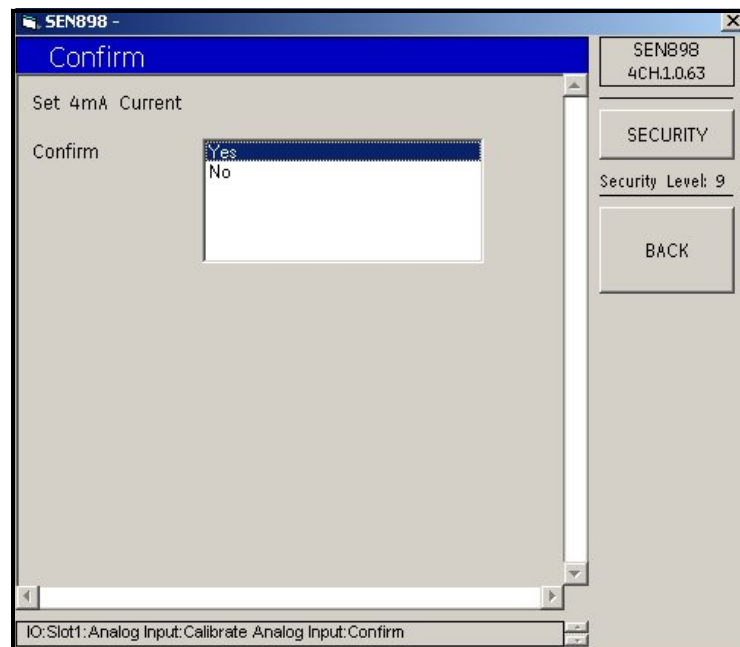

**Figure 191: Calibration Confirmation**

12. Click twice on Yes to confirm the calibration, or No to reject it. The screen returns to the Analog Input Calibration Options screen.

13. Repeat Steps 11 and 12 for Trim Span... and Reset Trim... as needed.

### 5.9.4.2 RTD Input Card

1. To assign a different Option Card to Slot 1, return to the Slot 1 Options screen and click twice on another option. If an RTD input card was selected, the following screen appears.

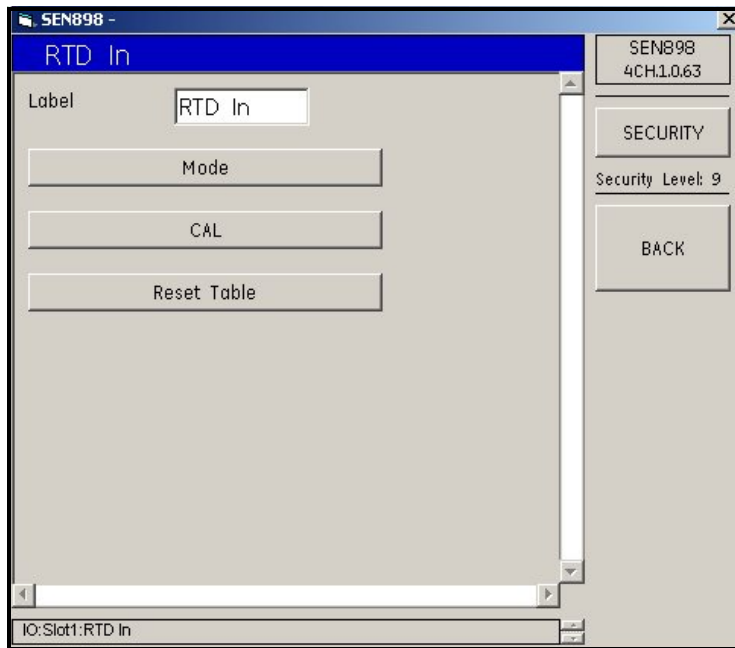

Figure 192: RTD Input Menu

2. To change the card label, enter the new name into the text box, click on BACK, and click Yes on the Verification screen to complete the choice.
3. Click on Mode, and the following screen appears.

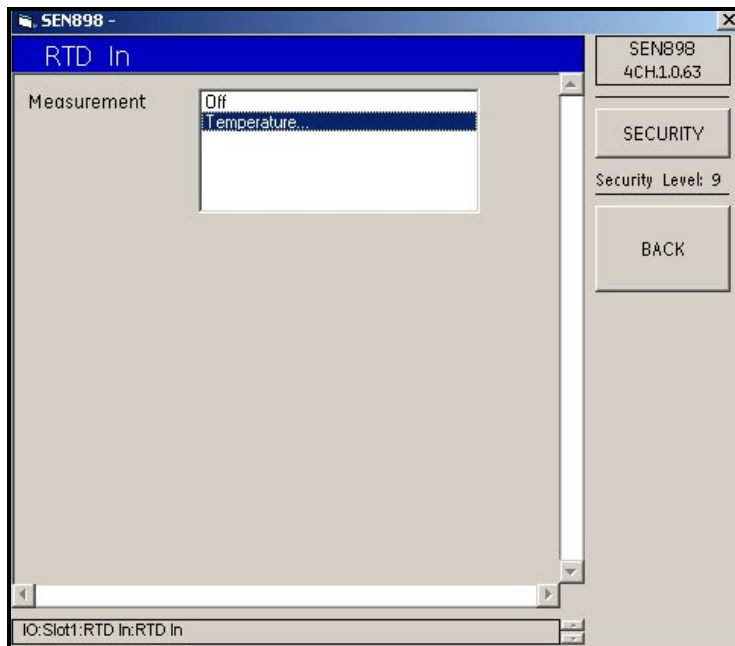

Figure 193: RTD Input Measurement Options

### 5.9.4.2 RTD Input Card (cont.)

- Choose the appropriate Measurement option and click on it twice. If Off is selected, the Measurement is turned off, and the screen returns to the RTD Input Card Menu. If Temperature... is selected, the following screen appears.

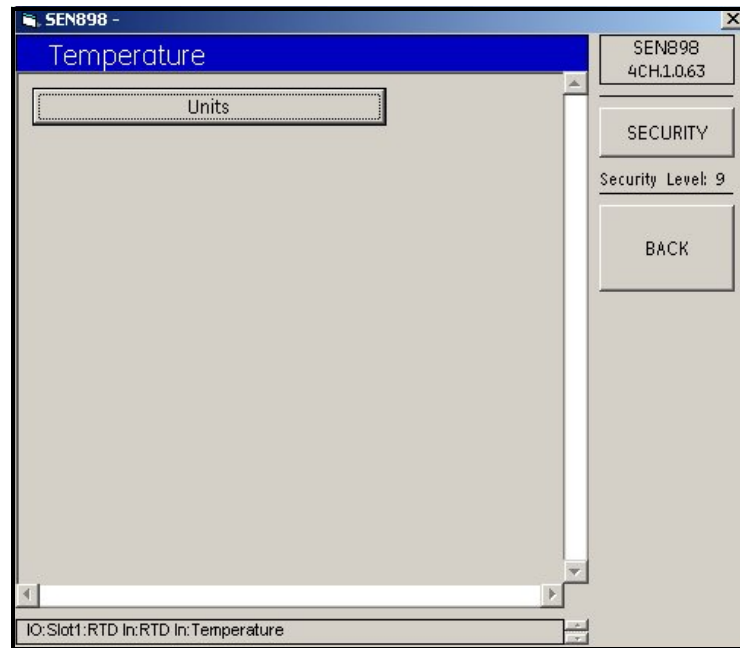

Figure 194: Temperature Menu

- Click on Units, and the following screen appears.

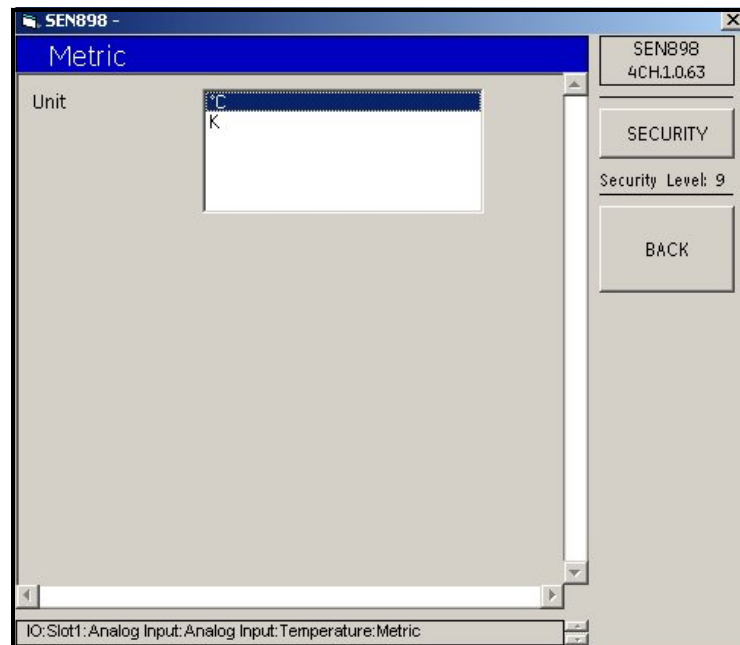
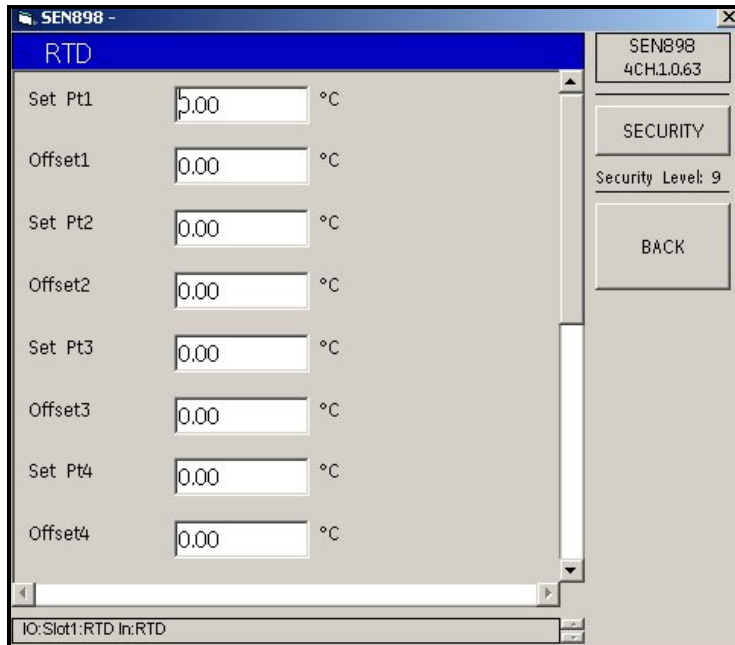

Figure 195: Temperature Unit Options

- Click twice on the appropriate Unit, and the screen returns to the Temperature Menu.

### 5.9.4.2 RTD Input Card (cont.)

7. To calibrate the RTD Input, click on CAL, and the following screen appears.



**Figure 196: RTD Input Calibration Options**

8. Enter the Set Pt or Offset temperature into each text box, click on BACK, and confirm the value by clicking Yes on the Verification screen. Click on BACK to return to the RTD Input Menu.
9. Click on Reset Table and the following screen appears.

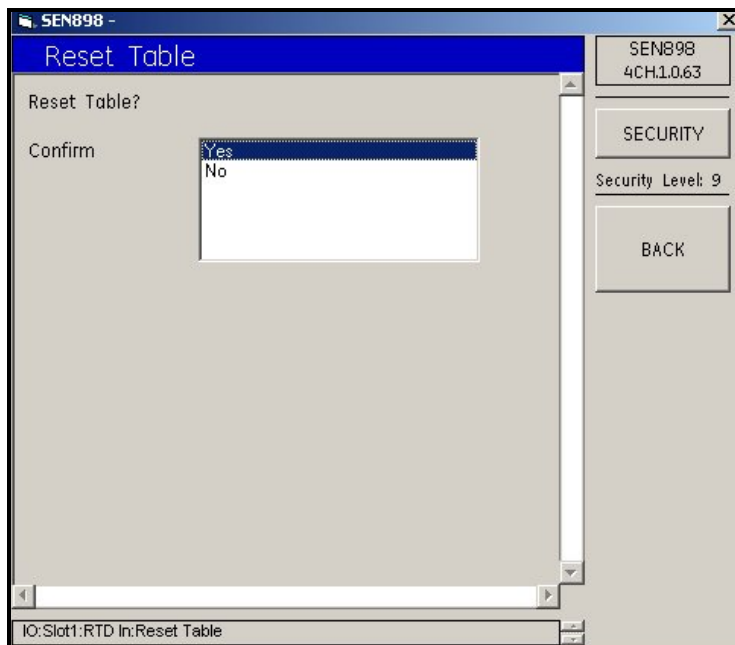

**Figure 197: Reset Table Confirmation**

10. Click Yes twice to confirm the resets, or No to reject them. The screen returns to the RTD Input Menu.

### 5.9.5 Slot 2 Setup

Use the same procedure to set up Slot 2 as was used for Slot 1, beginning on page 146.

## 5.10 Display Menu

### 5.10.1 Views Setup

1. Click twice on Display Menu and the following screen appears.

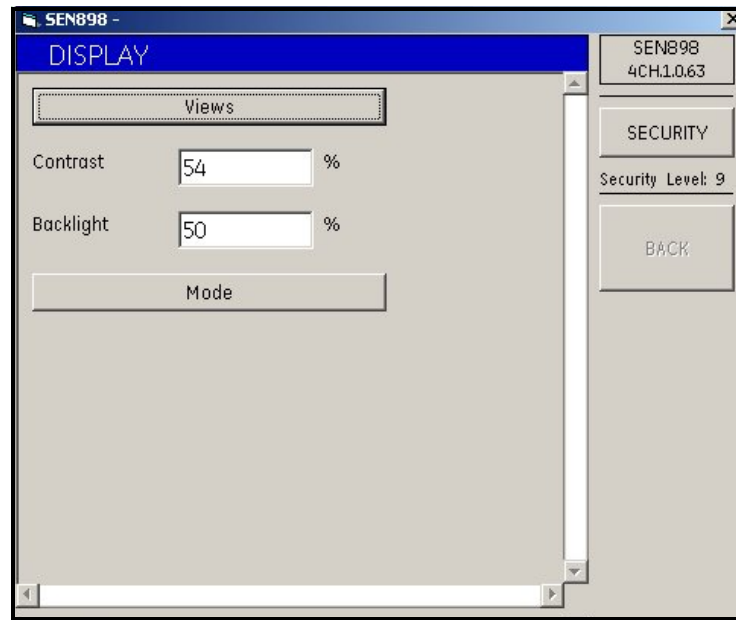

Figure 198: Display Menu

2. Click on Views and the following screen appears.

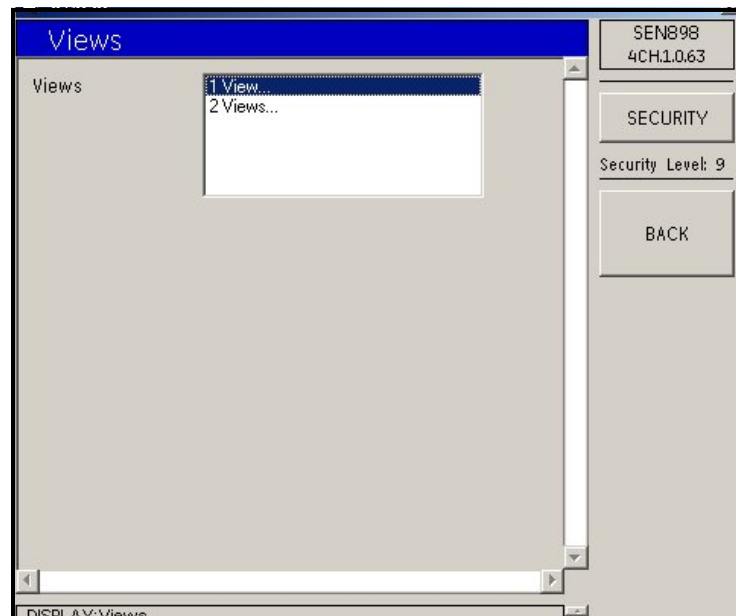

Figure 199: Views Options

#### 5.10.1.1 One View

3. Click twice on either 1 View... or 2 Views... If 1 View... is selected, the following screen appears.

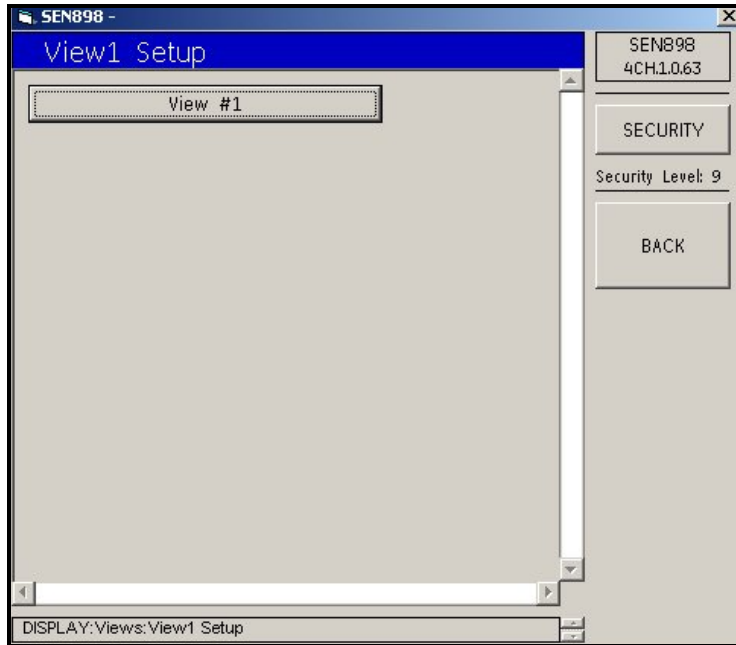

Figure 200: View 1 Setup

4. Click on View #1 and the following screen appears.

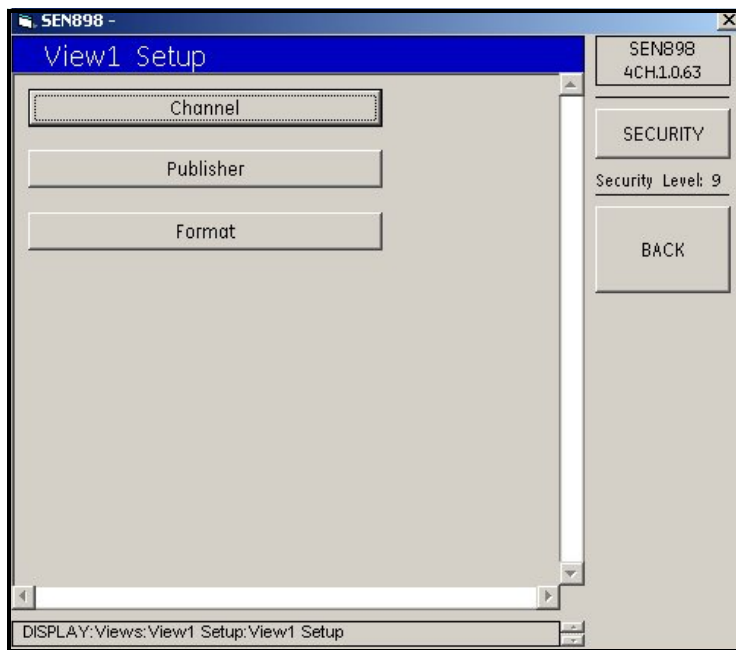
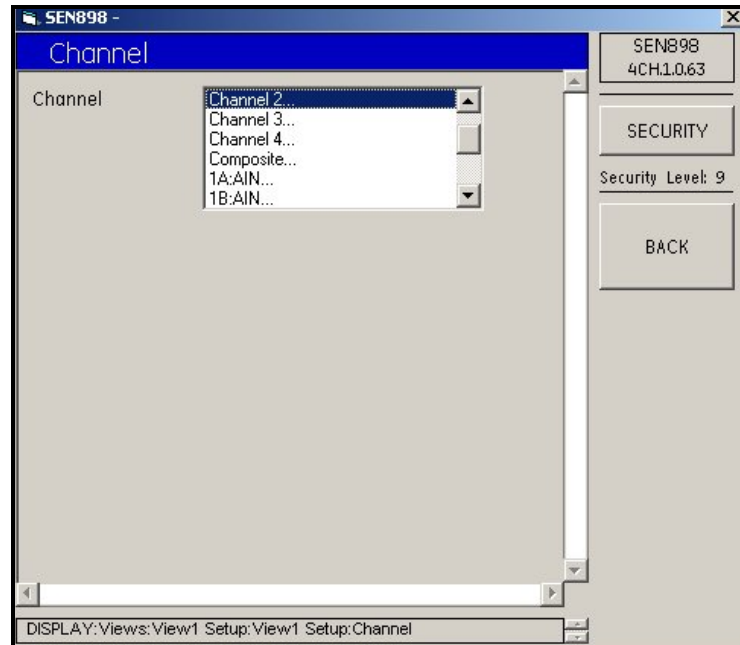

Figure 201: View 1 Setup Menu

### 5.10.1.1 One View (cont.)

- Click on Channel and the following screen appears.



**Figure 202: Channel Options**

- Click twice on the appropriate Channel, and the screen returns to the View 1 Setup Menu.
- Click on Publisher, and the following screen appears.

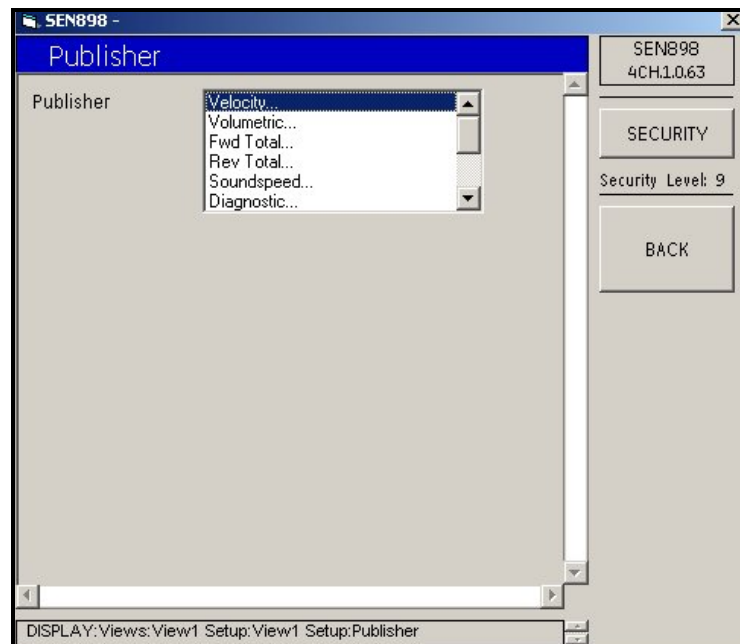

**Figure 203: Publisher Options**

### 5.10.1.1 One View (cont.)

8. Click twice on the appropriate Publisher, and the following screen appears.

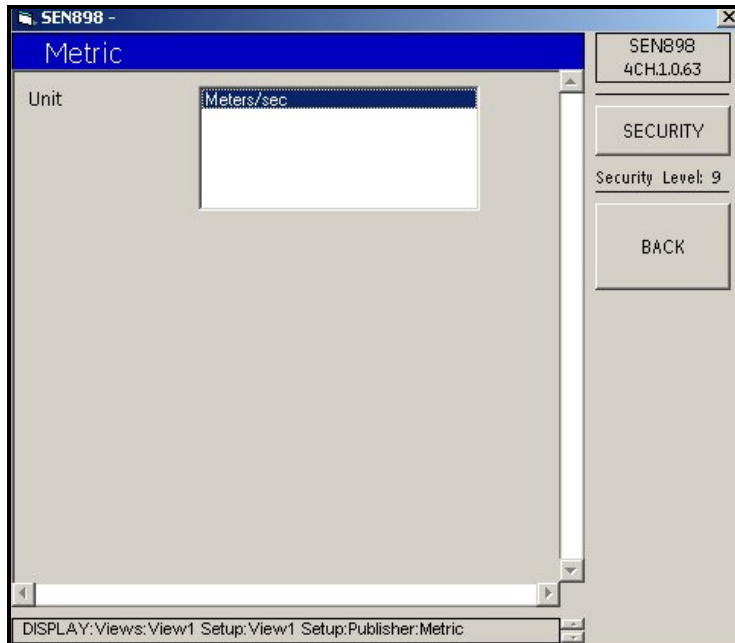

**Figure 204: Publisher Unit Options**

9. Click twice on the appropriate Unit, and click on BACK to return to the View 1 Setup Menu.

10. Click on Format, and the following screen appears.

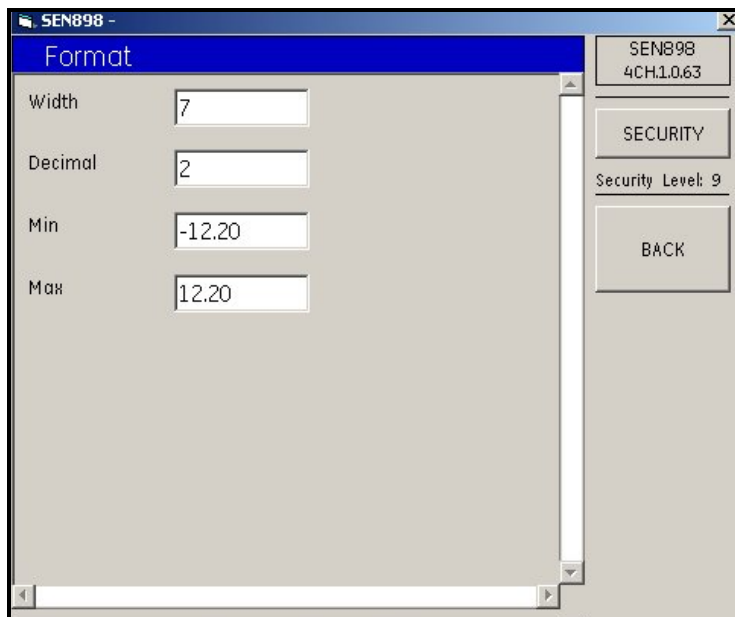

**Figure 205: Format Menu**

11. Enter the appropriate number into each text box, click on BACK, and confirm the value by clicking Yes on the Verification screen. Click on BACK to return to the previous screen.



### 5.10.1.2 Two Views

- If two views are required, return to the Display Menu, select 2 Views..., and proceed as in One View, beginning on page 153.

### 5.10.2 Contrast and Backlight

- On the Display Menu, to adjust the Contrast and/or Backlight, enter a number into each text box, click somewhere outside the boxes, and confirm the value by clicking Yes on the Verification screen.

### 5.10.3 Display Mode Setup

1. On the Display Menu, click on Mode, and the following screen appears.

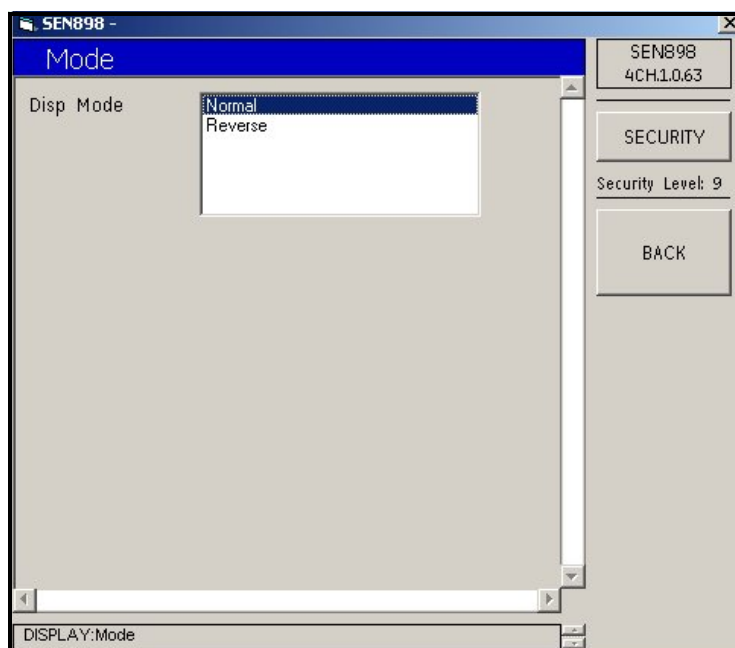

Figure 206: Display Mode Options

2. Click twice on the appropriate Mode, and the screen returns to the Display Menu.

## 5.11 Calibrate Menu

1. To set up the input/output calibration, click twice on Cal Menu, and the following screen appears.

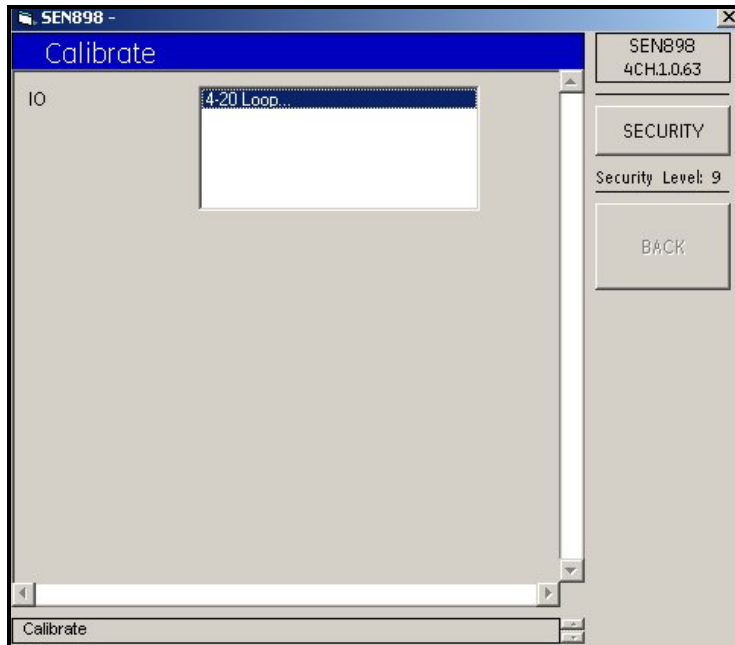

Figure 207: Calibrate Menu

2. Click twice on 4-20 Loop... and the following screen appears.

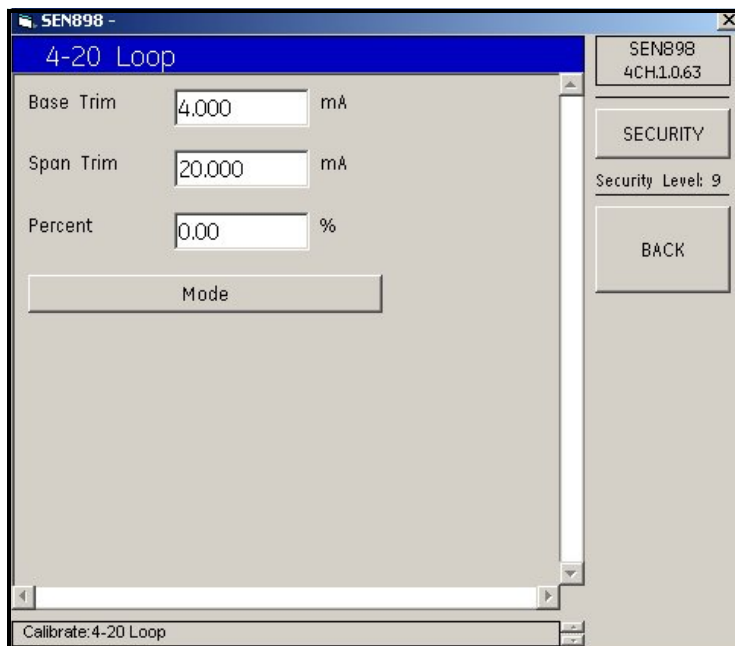

Figure 208: 4-20 Loop Setup Menu

3. To change Base Trim, Scan Trim or Percent values, enter the appropriate number into the text box, click on BACK, and confirm the value by clicking Yes on the Verification screen.

## 5.11 Calibrate Menu (cont.)

- To select a loop mode, click on Mode, and the following screen appears.

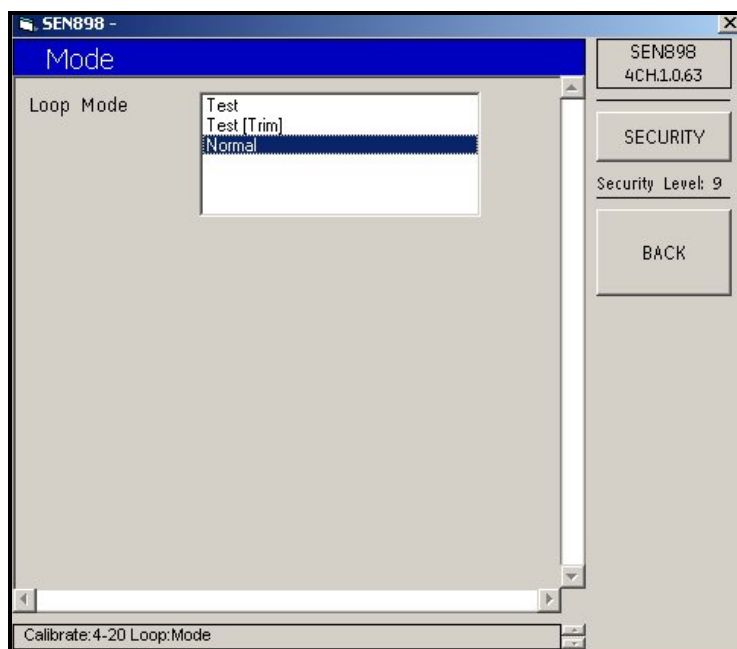

Figure 209: 4-20 Loop Mode Options

- Click twice on the appropriate option, and the screen returns to the previous menu. Click on BACK to return to the Calibrate Menu. Exit the original Cal Menu by clicking the X in the upper right-hand corner of the screen.

## 5.12 User Menu

### 5.12.1 Edit Passcodes

1. To provide security by limiting those with access to the meter programming setup, click twice on User Menu. The following screen appears.

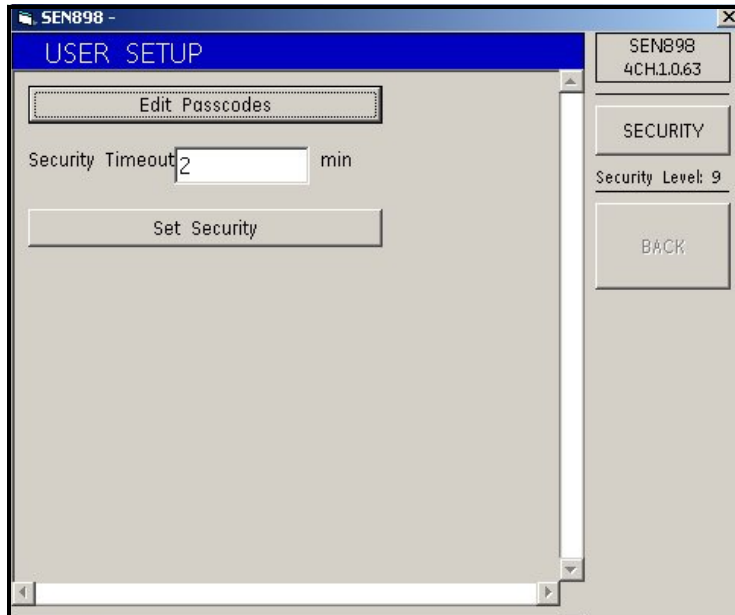

Figure 210: User Setup Menu

2. Click on Edit Passcodes to specify those passcodes with access. The following screen appears.

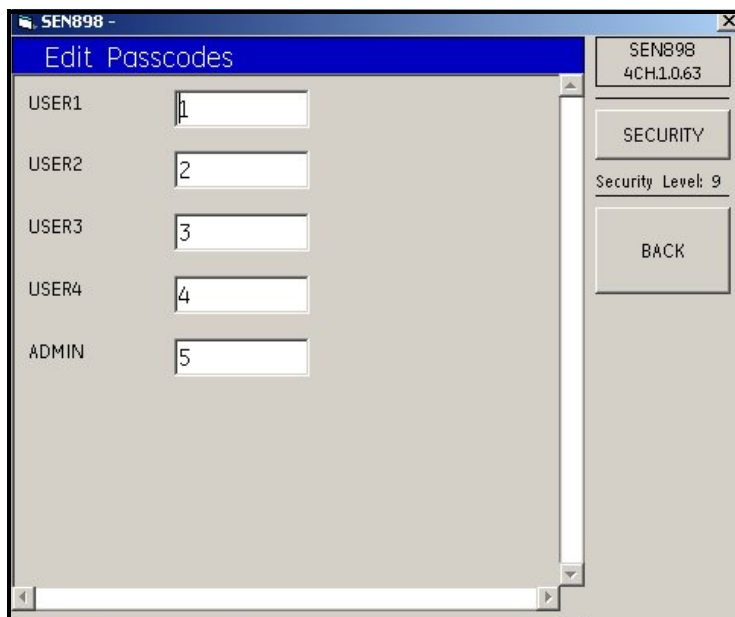
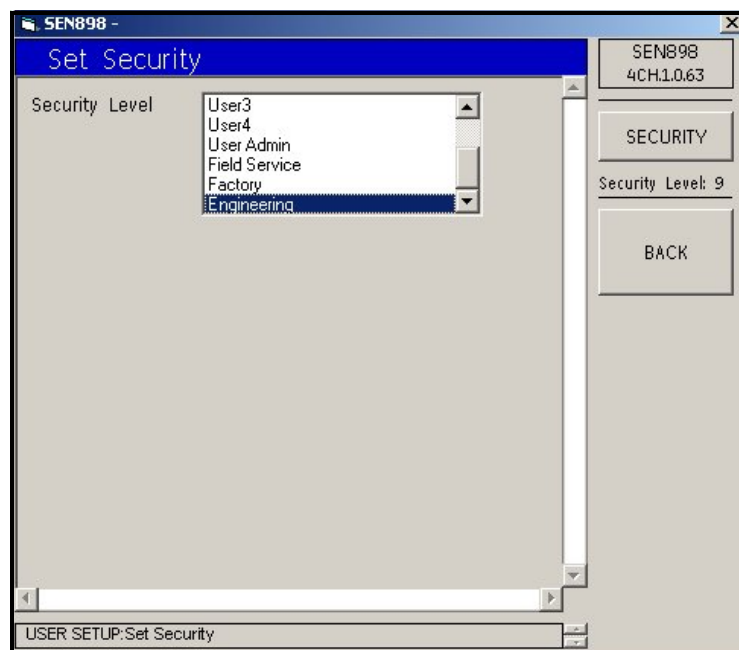

Figure 211: Edit Passcodes Menu

3. To enter a user passcode, type the appropriate text into the text box, click on BACK, and confirm the value by clicking Yes on the Verification screen. When finished, click on BACK to return to the User Setup Menu.

### 5.12.2 Set Security

1. To change the Security Timeout, type the appropriate number of minutes into the text box, click on BACK, and confirm the value by clicking Yes on the Verification screen.
2. Click on Set Security and the following screen appears.



**Figure 212: Security Level Options**

Click twice on the appropriate level of security, and the screen returns to the User Setup Menu. Exit the User Setup Menu by clicking the X in the upper right-hand corner of the screen.

## 5.13 Factory Menu

1. Click twice on Factory Menu, and the following screen appears.

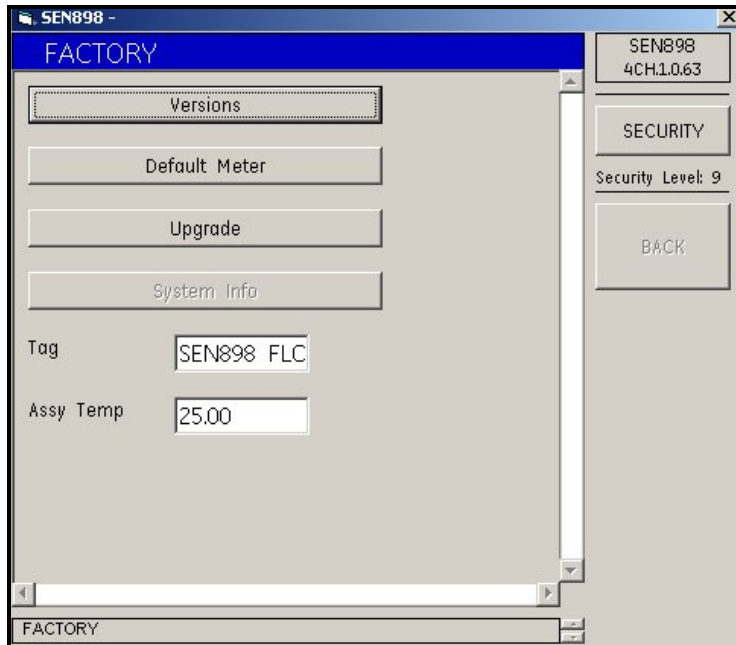

Figure 213: Factory Menu

### 5.13.1 Checking Versions

1. To check the unit's version information, click on Versions, and the following screen appears.

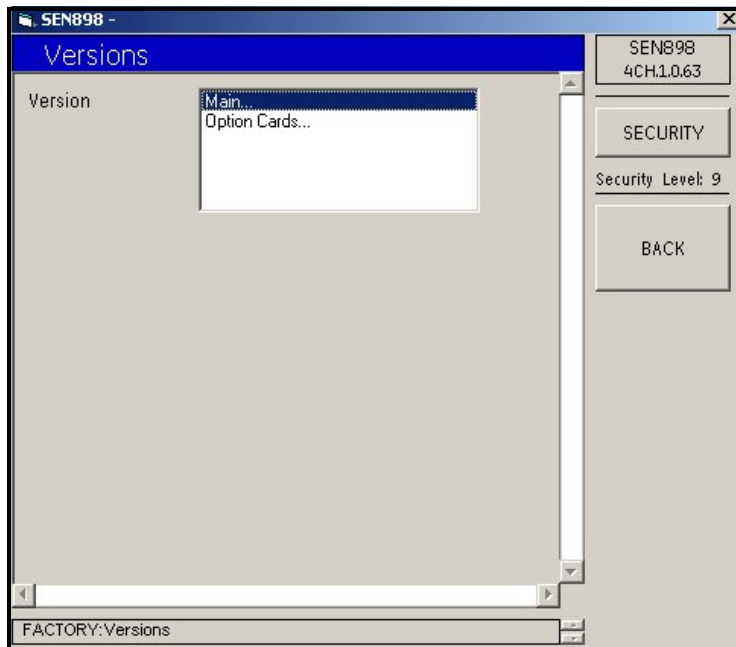

Figure 214: Version Options

### 5.13.1 Checking Versions (cont.)

- Click twice on Main... and the following screen appears. Click on BACK to return to the previous screen.

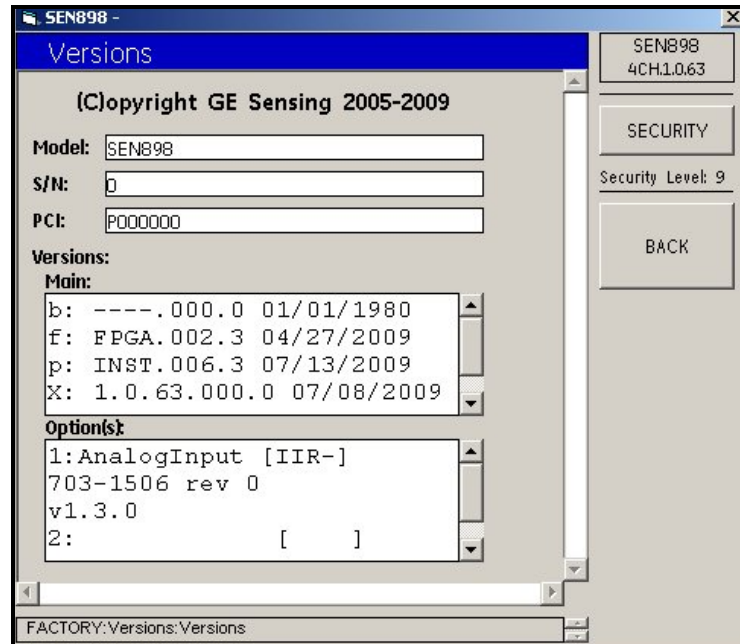

Figure 215: Main Version Information

- Click twice on Option Cards... and the following screen appears.

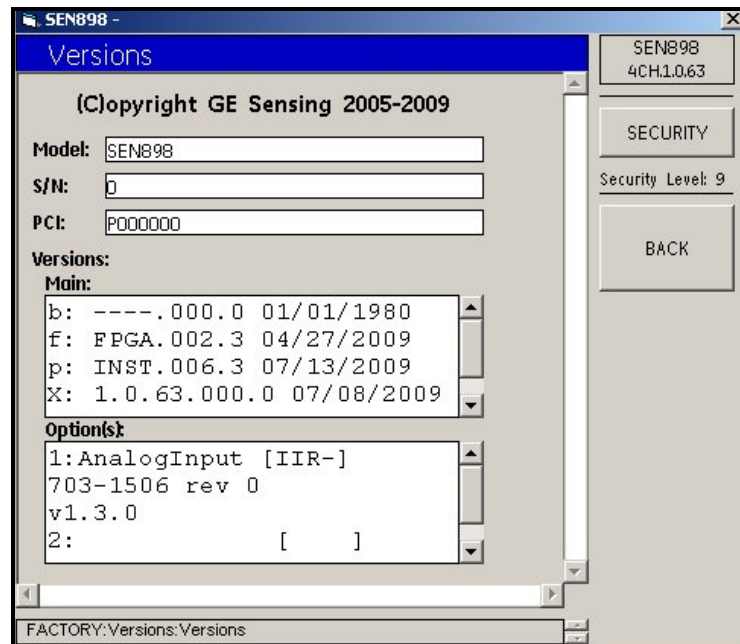

Figure 216: Option Cards Version Information

- Click twice on BACK to return to the FACTORY menu.

### 5.13.2 Confirming Meters

5. Click on Default Meter and the following screen appears.

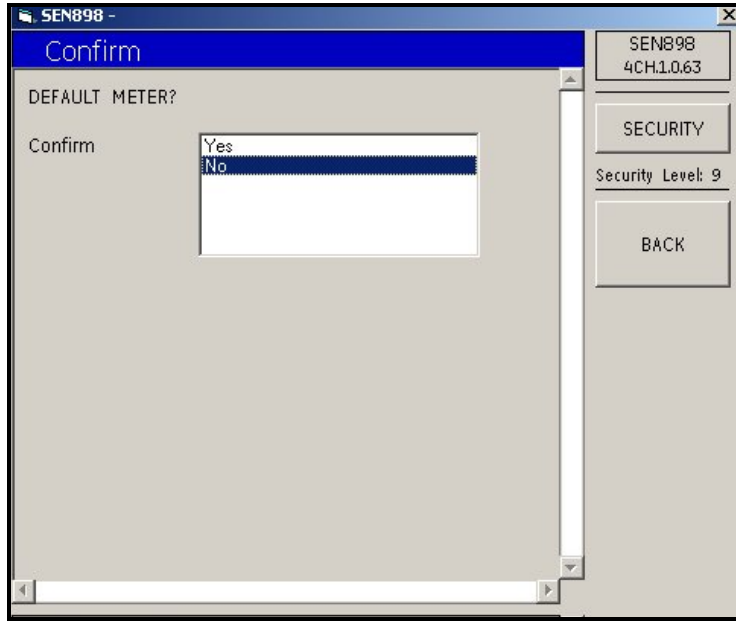

Figure 217: Confirm Default Meter

6. To confirm the Default Meter, click twice on Yes. To not confirm, click twice on No. The screen returns to the Factory Menu.
7. Click on Upgrade and the following screen appears.

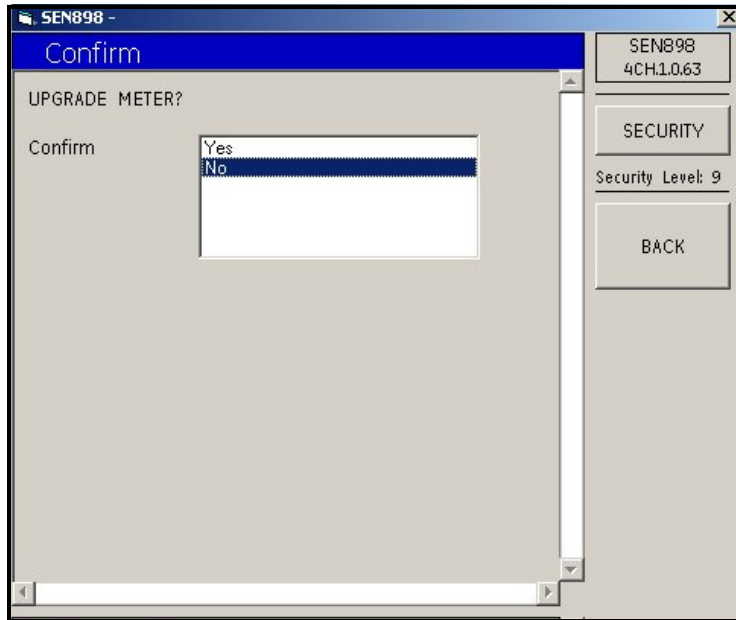

Figure 218: Confirm Upgraded Meter



### 5.13.2 Confirming Meters (cont.)

8. To confirm the Upgrade Meter, click twice on Yes. To not confirm, click twice on No. The screen returns to the Factory Menu.
9. From the Factory Menu, to change the Tag (name) or the Assy Temp value, enter the appropriate number into the text box, click outside the box, and confirm the value by clicking Yes on the Verification screen.
10. Exit the Factory Menu by clicking the X in the upper right-hand corner of the screen.



## Chapter 6. MODBUS Communications

### 6.1 Introduction

The Sentinel LNG supports digital communications using the MODBUS/RTU protocol, with 2-wire RS-485 or 3-wire RS-232C as the physical layer. Data rate can be specified from 4800 to 19200 bits per second (bps), with selectable parity.

### 6.2 Setting Up MODBUS Communications

1. To set up MODBUS Communications, from the main screen, use the arrow keys to scroll to [CONFIG]. Select Communication and press ENTER, select Modbus and press ENTER. Nine options appear.
2. **Address:** To change the MODBUS address, use the arrow keys to select Address and press [ENT]. Use the arrow keys to change the address number, and press [ENT] to save the change, or [ESC] to reject it. The screen returns to the CONFIG menu.
3. **Interface:** To set the interface to be used, from the CONFIG menu select Interface and press [ENT]. Two options appear: RS232 and RS485. Use the arrow keys to select the appropriate interface, and press [ENT]. The screen returns to the CONFIG menu.
4. **WordOrder:** To set the word order, from the CONFIG menu select WordOrder and press [ENT]. Two options appear: LowWordFirst and HighWord First. Use the arrow keys to select the appropriate order, and press [ENT]. The screen returns to the CONFIG menu.
5. **Baud Rate:** To set the baud rate, from the CONFIG menu select Baud Rate and press [ENT]. Three options appear: 4800, 9600 and 19200. Use the arrow keys to select the appropriate option, and press [ENT]. The screen returns to the CONFIG menu.
6. **Parity:** To set the parity, from the CONFIG menu select Parity and press [ENT]. Three options appear: None, Even and Odd. Use the arrow keys to select the appropriate option, and press [ENT]. The screen returns to the CONFIG menu.
7. **Volumetric:** To set the volumetric measurement, from the CONFIG menu select Volumetric and press [ENT]. Twelve options appear. Use the arrow keys to select the appropriate measurement type, and press [ENT]. The screen returns to the CONFIG menu.
8. **Total Units:** To set the total units measurement, from the CONFIG menu select Total Units, and press [ENT]. Four options appear: M<sup>3</sup>, Liters, Hectare-cm and Hectare-m. Use the arrow keys to select the appropriate measurement type, and press [ENT]. The screen returns to the CONFIG menu.
9. **StdVolumetric:** To set the standard volumetric measurement, from the CONFIG menu select StdVolumetric and press [ENT]. Twelve options appear. Use the arrow keys to select the appropriate measurement type, and press [ENT]. The screen returns to the CONFIG menu.
10. **StdTotal Units:** To set the standard total units measurement, from the CONFIG menu select StdTotal Units, and press [ENT]. Four options appear: M<sup>3</sup>, Liters, Hectare-cm and Hectare-m. Use the arrow keys to select the appropriate measurement type, and press [ENT]. The screen returns to the CONFIG menu.

Modbus Communications are now set up and ready to use. Proceed to the following pages.

## 6.2 Setting Up MODBUS Communications (cont.)

**Note:** Regarding meter status, each bit field indicates the error number from LSB corresponding to E1, and from MSB corresponding to E32.

**Note:** Writing any non-zero value will clear the totals (unless they are locked using TOT LOCK/KEY LOCK switches on the front panel – per MID requirements).

**Note:** Writing to COMP will clear all channels.

**Note:** The Modbus Register Map, Table 4 on page 168, has some fields highlighted in BLUE. These are currently not supported and will return a value of -1.0.

**Table 4: Modbus Register Map**

Category	Measurement	Type	Size Format	Composite Register Address	Channel 1 Register Address	Channel 2 Register Address	Channel 3 Register Address	Channel 4 Register Address
Primary Measurement	Velocity	F	2 LSW float	1 0x0000	1025 0x0400	2049 0x0800	3073 0x0C00	4097 0x1000
	Volumetric	F	2 LSW float	3 0x0002	1027 0x0402	2051 0x0802	3075 0x0C02	4099 0x1002
	Std Volumetric	F	2 LSW float	5 0x0004	1029 0x0404	2053 0x0804	3077 0x0C04	4101 0x1004
	Mass Flow	F	2 LSW float	7 0x0006	1031 0x0406	2055 0x0806	3079 0x0C06	4103 0x1006
	Energy Rate	F	2 LSW float	9 0x0008	1033 0x0408	2057 0x0808	3081 0x0C08	4105 0x1008
Transit Time	Soundspeed	F	2 LSW float	11 0x000A	1035 0x040A	2059 0x080A	3073 0x0C00	4097 0x1000
	Up Transit	F	2 LSW float	13 0x000C	1037 0x040C	2061 0x080C	3075 0x0C02	4099 0x1002
	Dn Transit	F	2 LSW float	15 0x000E	1039 0x040E	2063 0x080E	3077 0x0C04	4101 0x1004
	DeltaT	F	2 LSW float	17 0x0010	1041 0x0410	2065 0x0810	3079 0x0C06	4103 0x1006
Receiver Diagnostics	UP Sig Strength	F	2 LSW float	19 0x0012	1043 0x0412	2049 0x0812	3091 0x0C12	4115 0x1012
	DN Sig Strength	F	2 LSW float	21 0x0014	1045 0x0414	2051 0x0814	3093 0x0C14	4117 0x1014
	Gain Up[dB]	F	2 LSW float	23 0x0016	1047 0x0416	2053 0x0816	3095 0x0C16	4119 0x1016
	Gain Dn[dB]	F	2 LSW float	25 0x0018	1049 0x0418	2055 0x0818	3097 0x0C18	4121 0x1018
	UP DAC	F	2 Unsigned integer	27 0x001A	1051 0x041A	2057 0x081A	3099 0x0C1A	4123 0x101A
	DN DAC	F	2 Unsigned integer	29 0x001C	1053 0x041C	2059 0x081C	3101 0x0C1C	4125 0x101C
	UP Amp Discrim	F	2 LSW float	31 0x001E	1055 0x041E	2061 0x081E	3103 0x0C1E	4127 0x101E
	DN Amp Discrim	F	2 LSW float	33 0x0020	1057 0x0420	2063 0x0820	3105 0x0C20	4129 0x1020
Signal Processing Diagnostics	PEAK%	F	2 LSW float	35 0x0022	1059 0x0422	2083 0x0822	3107 0x0C22	4131 0x1022
	UP Signal Q	F	2 LSW float	37 0x0024	1061 0x0424	2085 0x0824	3109 0x0C24	4133 0x1024
	DN Signal Q	F	2 LSW float	39 0x0026	1063 0x0426	2087 0x0826	3111 0x0C26	4135 0x1026
	UP +- Peak	F	2 LSW float	41 0x0028	1065 0x0428	2089 0x0828	3113 0x0C28	4137 0x1028
	DN +- Peak	F	2 LSW float	43 0x002A	1067 0x042A	2091 0x082A	3115 0x0C2A	4139 0x102A
	UP Norm Factor	F	2 LSW float	45 0x002C	1069 0x042C	2093 0x082C	3117 0x0C2C	4141 0x102C
	DN Norm Factor	F	2 LSW float	47 0x002E	1071 0x042E	2095 0x082E	3119 0x0C2E	4143 0x102E
	Theta 3 CEE1	F	2 LSW float	49 0x0030 51 0x0032	1073 0x0430 1075 0x0432	2097 0x0830 2099 0x0832	3121 0x0C30 3123 0x0C32	4145 0x1030 4147 0x1032

Table 4: Modbus Register Map (cont.)

Category	Measurement	Type	Size Format	Composite Register Address	Channel 1 Register Address	Channel 2 Register Address	Channel 3 Register Address	Channel 4 Register Address
Correction Factors	Reynolds #	F	2 LSW float	53 0x0034	1077 0x0434	2101 0x0834	3125 0x0C34	4149 0x1034
	K(RE)	F	2 LSW float	55 0x0036	1079 0x0436	2103 0x0836	3127 0x0C36	4151 0x1036
	CTL <sup>1</sup>	F	2 LSW float	57 0x0038	1081 0x0438	2105 0x0838	3129 0x0C38	4153 0x1038
	CPL <sup>2</sup>	F	2 LSW float	59 0x003A	1083 0x043A	2107 0x083A	3131 0x0C3A	4155 0x103A
	CTPL <sup>3</sup>	F	2 LSW float	61 0x003C	1085 0x043C	2109 0x083C	3133 0x0C3C	4157 0x103C

<sup>1</sup>Correction factor for the effect of Temperature on the Liquid.

<sup>2</sup>Correction factor for the effect of Pressure on the Liquid.

<sup>3</sup>Correction factor for the effects of Temperature and Pressure on the Liquid, a.k.a. "full VCF," is product of CTL and CPL.

Temperature Inputs	Supply Temp	F	2 LSW float	63 0x003E	1087 0x043E	2111 0x083E	3125 0x0C3E	4159 0x103E
	Return Temp	F	2 LSW float	65 0x0040	1089 0x0440	2113 0x0840	3127 0x0C40	4161 0x1040
	Supply-Rtn	F	2 LSW float	67 0x0042	1091 0x0442	2115 0x0842	3129 0x0C42	4163 0x1042
	Supply Dens	F	2 LSW float	69 0x0044	1093 0x0444	2117 0x0844	3141 0x0C44	4165 0x1044
	Return Dens	F	2 LSW float	71 0x0046	1095 0x0446	2119 0x0846	3143 0x0C46	4167 0x1046
	Delta h	F	2 LSW float	73 0x0048	1097 0x0448	2121 0x0848	3145 0x0C48	4169 0x1048
Pressure Inputs	Pressure Input	F	2 LSW float	75 0x004A	1099 0x044E	2123 0x084A	3147 0x0C4A	4171 0x104A
Special Inputs	Special Input 1	F	2 LSW float	77 0x004C	1101 0x044C	2125 0x084C	3149 0x0C4C	4173 0x104C
	Special Input 2	F	2 LSW float	79 0x004E	1103 0x044E	2127 0x084E	3151 0x0C4E	4175 0x104E
	Special Input 3	F	2 LSW float	81 0x0050	1105 0x0450	2129 0x0850	3153 0x0C50	4177 0x1050
	Special Input 4	F	2 LSW float	83 0x0052	1107 0x0452	2131 0x0852	3155 0x0C52	4179 0x1052
Flow Totals	FWD Total	D	4 LSW double	129 0x0080	1153 0X0480	2177 0X0880	3201 0X0C80	4225 0X1080
	REV Total	D	4 LSW float	133 0x0084	1157 0X0484	2181 0X0884	3205 0X0C84	4229 0X1084
	FWD Mass	D	4 LSW double	137 0x0088	1161 0X0488	2185 0X0888	3209 0X0C88	4233 0X1088
	REV Mass	D	4 LSW double	141 0x008C	1165 0X048C	2189 0X088C	3213 0X0C8C	4237 0X108C
	FWD Energy	D	4 LSW double	145 0x0090	1169 0X0490	2193 0X0890	3217 0X0C90	4241 0X1090
	REV Energy	D	4 LSW double	149 0x0094	1173 0X0494	2197 0X0894	3221 0X0C94	4245 0X1094
	Totl. Time	D	4 LSW double	153 0x0098	1177 0X0498	2201 0X0898	3225 0X0C98	4249 0X1098
	STD FWD Total	D	4 LSW double	157 0x009C	1181 0X049C	2205 0X089C	3229 0X0C9C	4253 0X109C
	STD REV Total	D	4 LSW float	161 0x00A0	1185 0X04A0	2209 0X08A0	3233 0X0CA0	4257 0X10A0
	STD Totl. Time	D	4 LSW double	165 0x00A4	1189 0X04A4	2213 0X08A4	3237 0X0CA4	4261 0X10A4

Table 4: Modbus Register Map (cont.)

Category	Measurement	Type	Size Format	Composite Register Address	Channel 1 Register Address	Channel 2 Register Address	Channel 3 Register Address	Channel 4 Register Address
Flow Totals (scientific notation)	FWD Total Register 0	L	2 LSW double	257 0x0100	1281 0X0500	2305 0X0900	3329 0X0D00	4353 0X1100
	FWD Total Register 1	L	2 LSW float	259 0x0102	1283 0X0502	2307 0X0902	3331 0X0D02	4355 0X1102
	FWD Total Register 2	L	2 LSW float	261 0x0104	1285 0X0504	2309 0X0904	3333 0X0D04	4357 0X1104
	REV Total Register 0	L	2 LSW float	263 0x0106	1287 0X0506	2311 0X0906	3335 0X0D06	4359 0X1106
	REV Total Register 1	L	2 LSW float	265 0x0108	1289 0X0508	2313 0X0908	3337 0X0D08	4361 0X1108
	REV Total Register 2	L	2 LSW float	267 0x010A	1291 0X050A	2315 0X090A	3339 0X0D0A	4363 0X110A
	FWD Mass Register 0	L	2 LSW double	269 0x010C	1293 0X050C	2317 0X090C	3341 0X0D0C	4365 0X110C
	FWD Mass Register 1	L	2 LSW double	271 0x010E	1295 0X050E	2319 0X090E	3343 0X0D0E	4367 0X110E
	FWD Mass Register 2	L	2 LSW double	273 0x0110	1297 0X0510	2321 0X0910	3345 0X0D10	4369 0X1110
	REV Mass Register 0	L	2 LSW double	275 0x0112	1299 0x0512	2323 0x0912	3347 0x0D12	4371 0X1112
Flow Totals (scientific notation)	REV Mass Register 1	L	2 LSW double	277 0x0114	1301 0x0514	2325 0x0914	3349 0x0D14	4373 0X1114
	REV Mass Register 2	L	2 LSW double	279 0x0116	1303 0x0516	2327 0x0916	3351 0x0D16	4375 0X1116
	FWD Energy Register 0	L	2 LSW double	281 0x0118	1305 0x0518	2329 0x0918	3353 0x0D18	4377 0X1118
	FWD Energy Register 1	L	2 LSW double	283 0x011A	1307 0x051A	2331 0x091A	3355 0x0D1A	4379 0X111A
	FWD Energy Register 2	L	2 LSW double	285 0x011C	1309 0x051C	2333 0x091C	3357 0x0D1C	4381 0X111C
	REV Energy Register 0	L	2 LSW double	287 0x011E	1311 0x051E	2335 0x091E	3359 0x0D1E	4383 0X111E
	REV Energy Register 1	L	2 LSW double	289 0x0120	1313 0x0520	2337 0x0920	3361 0x0D20	4385 0X1120
	REV Energy Register 2	L	2 LSW double	291 0x0122	1315 0x0522	2339 0x0922	3363 0x0D22	4387 0X1122
	Totl. Time days <sup>4</sup>	L	2 LSW double	293 0x0124	1317 0x0524	2341 0x0924	3365 0x0D24	4389 0X1124
	Totl. Time seconds	L	2 LSW double	295 0x0126	1319 0x0526	2343 0x0926	3367 0x0D26	4391 0X1126
	STD FWD Total Register 0	L	2 LSW double	297 0x0128	1321 0x0528	2345 0x0928	3369 0x0D28	4393 0X1128
	STD FWD Total Register 1	L	2 LSW float	299 0x012A	1323 0x052A	2347 0x092A	3371 0x0D2A	4395 0X112A
	STD FWD Total Register 2	L	2 LSW float	301 0x012C	1325 0x052C	2349 0x092C	3373 0x0D2C	4397 0X112C
	STD REV Total Register 0	L	2 LSW float	303 0x012E	1327 0x052E	2351 0x092E	3375 0x0D2E	4399 0X112E

**Table 4: Modbus Register Map (cont.)**

Category	Measurement	Type	Size Format	Composite Register Address	Channel 1 Register Address	Channel 2 Register Address	Channel 3 Register Address	Channel 4 Register Address
	STD REV Total Register 1	L	2 LSW float	305 0x0130	1329 0x0530	2353 0x0930	3377 0x0D30	4401 0x1130
	STD REV Total Register 2	L	2 LSW float	307 0x0132	1331 0x0532	2355 0x0932	3379 0x0D32	4403 0x1132
	Std Totl. Time days <sup>4</sup>	L	2 LSW double	309 0x0134	1333 0x0534	2357 0x0934	3381 0x0D34	4405 0x1134
	Std Totl. Time seconds	L	2 LSW double	311 0x0136	1335 0x0536	2359 0x0936	3383 0x0D36	4407 0x1136

<sup>4</sup>1 day = 86,400 seconds

Meter Status	Error Code <sup>5</sup>	B	2 LSW unsigned long integer	385 0x0180	1409 0x0580	2433 0x0980	3457 0x0D80	4481 0x1180
Meter Control	Reset Totals <sup>6</sup>	I	1 Unsigned integer	513 0x0200	1537 0x0600	2561 0x0A00	3585 0x0E00	4609 0x1200
	Reset Batch Total	I	1 Unsigned integer	514 0x0201	1538 0x0601	2562 0x0A01	3586 0x0E01	4610 0x1201
	Error Code <sup>7</sup>	I	1 Unsigned integer	515 0x0202	1539 0x0602	2563 0x0A02	3587 0x0E02	4611 0x1202
Comm Settings	Word Order	I	1 Unsigned integer	5121 0x1400				
	Baud Rate	I	1 Unsigned integer	5122 0x1401				
	Parity	I	1 Unsigned integer	5123 0x1402				
	Stop Bits	I	1 Unsigned integer	5124 0x1403				
	Meter Address	I	1 Unsigned integer	5125 0x1404				
	All Ones	I	1 Unsigned integer	5126 0x1405				

<sup>5</sup>Each of the 32 bits represents an error type.<sup>6</sup>Writing any non-zero value will clear totals (unless locked per MID requirements).<sup>7</sup>Represented as integer value (i.e. E1, E2, E3, etc.)





## Chapter 7. HART Communications

### 7.1 Introduction

The **Sentinel LNG** generates a 4-20 mA analog output signal that enables two-way communication with a HART communication device.

### 7.2 Wiring the HART Interface

1. Interconnect the HART interface and the HART device as shown in Figure 219 below.

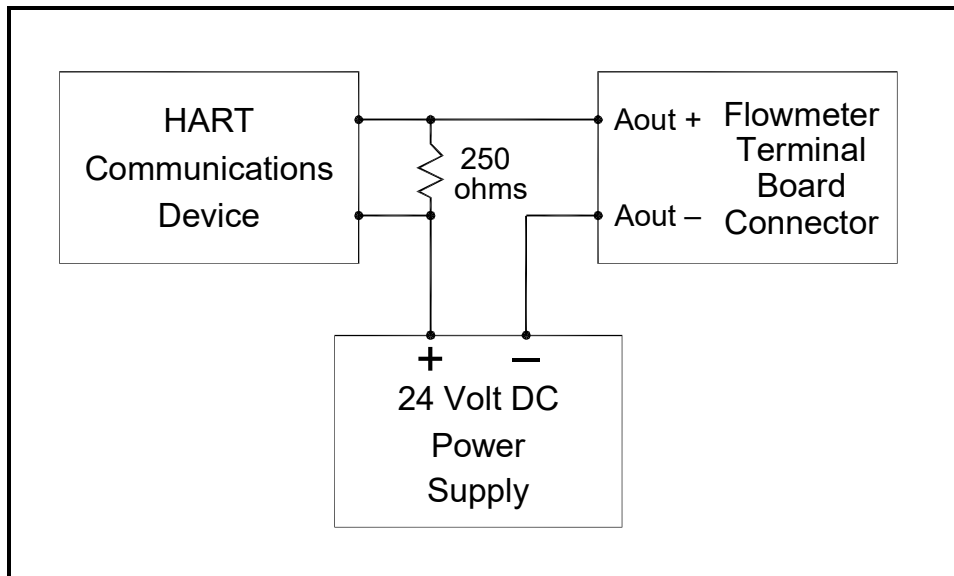

**Figure 219: HART Wiring (Ext. Supply/Passive Mode)**

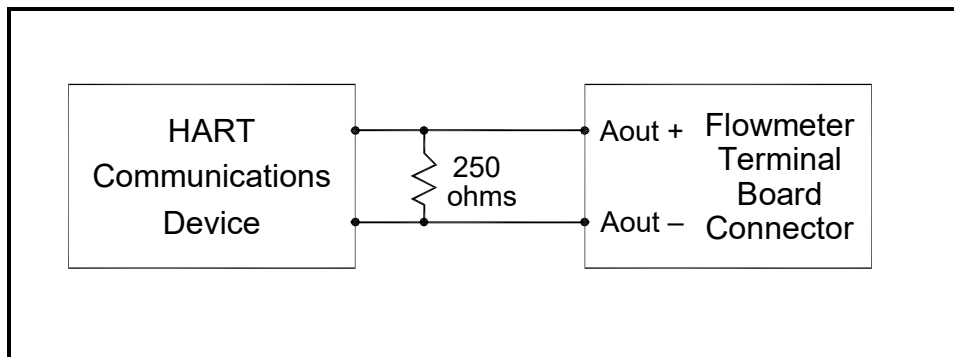

**Figure 220: HART Wiring (Int. Supply/Active Mode)**

## 7.3 Flowmeter Software Setup

**Sentinel LNG**'s require no special setup procedures by the user. The meter automatically configures itself for HART communication on startup. The analog output must be on, and the mode must be set to the desired state. See [I/O], analog output menu.

In addition to setting up the HART variables and configuration, the analog output may be configured using either of the following methods (if available):

- the flowmeter keypad
- PanaView™ graphical user interface software

The choice of parameters must be limited to those listed in Table 14 on page 3. To use the HART device for configuration of the analog output, refer to the instructions that came with that device.

Some flowmeter parameters can be read only by the HART device during startup. It is recommended that both the flowmeter and the HART device be rebooted after any reprogramming of the HART parameters. Failure to do so may result in erroneous information or a communication failure between the flowmeter and the HART device.

## 7.4 Product Interfaces

### 7.4.1 Process Interface

#### 7.4.1.1 Sensor Input Channels

One to four pairs of acoustic transducers are connected to the device. Additionally, as many as three temperature, pressure or density probes may be wired to the flowmeter. The temperature probe(s) can be either four-wire PT100 RTDs or, like the pressure sensors, 4-20 mA transmitters. Refer to the manuals for connection instructions.

#### 7.4.1.2 Actuator Output Channels

No **Sentinel LNG** outputs are designated exclusively as external process-control actuators.

## 7.4.2 Host Interface

### 7.4.2.1 Analog Output

The **Sentinel LNG** is equipped with a single 4–20 mA output, which can be configured using software to supply 24-volt power internally (active), or to regulate current from an external source (passive). When set to either mode it will support the HART communication channel.

	Direction	Values (percent of range)	Values (ma or V)
Linear Over-Range	Down	-0.6% ± 1.0%	3.89 to 3.92mA
	Up	+105.0% ± 1.0%	20.64 to 20.96mA
Device Malfunction Indication	Down: less than	-1.0%	3.84mA
	Up: greater than	+110.0%	21.6mA
Maximum Current		+112.5%	22.0mA
Multi-Drop Current Draw			4.0mA
Lift-Off Voltage			4.5V

## 7.5 Device Variables

The quantity and complexity of flow rates, secondary measurements and diagnostics in the list precludes elaboration within the FDS. Refer to Chapter 3, *Operation*, for more information about each parameter. All **Sentinel LNG** Device Variable Codes are tabulated in Table 14 below.

Velocity	0 (00)	48 (30)	96 (60)	144 (90)	192 (C0)	67	Velocity
Volumetric	1 (01)	49 (31)	97 (61)	145 (91)	193 (C1)	66	Volumetric Flow
FWD Total	2 (02)	50 (32)	98 (62)	146 (92)	194 (C2)	68	Volume (FWD)
REV Total	3 (03)	51 (33)	99 (63)	147 (93)	195 (C3)	68	Volume (REV)
Totl. Time	4 (04)	52 (34)	100 (64)	148 (94)	196 (C4)	70	Time
Mass Flow	5 (05)	53 (35)	101 (65)	149 (95)	197 (C5)	72	Mass Flow
FWD Mass	6 (06)	54 (36)	102 (66)	150 (96)	198 (C6)	71	Mass (FWD)
REV Mass	7 (07)	55 (37)	103 (67)	151 (97)	199 (C7)	71	Mass (REV)
EnergyRate	8 (08)	56 (38)	104 (68)	152 (98)	200 (C8)	79	Power
FWD Energy	9 (09)	57 (39)	105 (69)	153 (99)	201 (C9)	77	Energy (FWD)
REV Energy	10 (0A)	58 (3A)	106 (6A)	154 (9A)	202 (CA)	77	Energy (REV)
Reynolds #	11 (0B)	59 (3B)	107 (6B)	155 (9B)	203 (CB)	0	Not Classified
K(RE)	12 (0C)	60 (3C)	108 (6C)	156 (9C)	204 (CC)	0	Not Classified
CTL	13 (0D)	61 (3D)	109 (6D)	157 (9D)	205 (CD)	0	Not Classified
CPL	14 (0E)	62 (3E)	110 (6E)	158 (9E)	206 (CE)	0	Not Classified
CTPL	15 (0F)	63 (3F)	111 (6F)	159 (9F)	207 (CF)	0	Not Classified
Soundspeed	16 (10)	64 (40)	112 (70)	160 (A0)	208 (D0)	67	Velocity
Up Transit	17 (11)	65 (41)	113 (71)	161 (A1)	209 (D1)	70	Time
Dn Transit	18 (12)	66 (42)	114 (72)	162 (A2)	210 (D2)	70	Time
DeltaT	19 (13)	67 (43)	115 (73)	163 (A3)	211 (D3)	70	Time

Gain Up[dB]	20 (14)	68 (44)	116 (74)	164 (A4)	212 (D4)	0	Not Classified
Gain Dn[db]	21 (15)	69 (45)	117 (75)	165 (A5)	213 (D5)	0	Not Classified
Up Sig Strength	22 (16)	70 (46)	118 (76)	166 (A6)	214 (D6)	0	Not Classified
DN Sig Strength	23 (17)	71 (47)	119 (77)	167 (A7)	215 (D7)	0	Not Classified
UP DAC	24 (18)	72 (48)	120 (78)	168 (A8)	216 (D8)	0	Not Classified
DN DAC	25 (19)	73 (49)	121 (79)	169 (A9)	217 (D9)	0	Not Classified
UP Amp Discrim	26 (1A)	74 (4A)	122 (7A)	170 (AA)	218 (DA)	0	Not Classified
DN Amp Discrim	27 (1B)	75 (4B)	123 (7B)	171 (AB)	219 (DB)	0	Not Classified
Peak%	28 (1C)	76 (4C)	124 (7C)	172 (AC)	220 (DC)	81	Analytical
UP Signal Q	29 (1D)	77 (4D)	125 (7D)	173 (AD)	221 (DD)	0	Not Classified
DN Signal Q	30 (1E)	78 (4E)	126 (7E)	174 (AE)	222 (DE)	0	Not Classified
UP +- Peak	31 (1F)	79 (4F)	127 (7F)	175 (AF)	223 (DF)	0	Not Classified
DN +- Peak	32 (20)	80 (50)	128 (80)	176 (B0)	224 (E0)	0	Not Classified
UP Norm Factor	33 (21)	81 (51)	129 (81)	177 (B1)	225 (E1)	0	Not Classified
DN Norm Factor	34 (22)	82 (52)	130 (82)	178 (B2)	226 (E2)	0	Not Classified
Theta 3	35 (23)	83 (53)	131 (83)	179 (B3)	227 (E3)	0	Not Classified
CEEI	36 (24)	84 (54)	132 (84)	180 (B4)	228 (E4)	67	Velocity
Supply Temp	37 (25)	85 (55)	133 (85)	181 (B5)	229 (E5)	64	Temperature
Return Temp	38 (26)	86 (56)	134 (86)	182 (B6)	230 (E6)	64	Temperature
Supply-Rtn	39 (27)	87 (57)	135 (87)	183 (B7)	231 (E7)	0	Not Classified
Supply Dens	40 (28)	88 (58)	136 (88)	184 (B8)	232 (E8)	0	Not Classified
Return Dens	41 (29)	89 (59)	137 (89)	185 (B9)	233 (E9)	0	Not Classified
Delta h	42 (2A)	90 (5A)	138 (8A)	186 (BA)	234 (EA)	0	Not Classified
Pressure Input	43 (2B)	91 (5B)	139 (8B)	187 (BB)	235 (EB)	65	Pressure
Special Input 1	44 (2C)	92 (5C)	140 (8C)	188 (BC)	236 (EC)	0	Not Classified
Special Input 2	45 (2D)	93 (5D)	141 (8D)	189 (BD)	237 (ED)	0	Not Classified
Special Input 3	46 (2E)	94 (5E)	142 (8E)	190 (BE)	238 (EE)	0	Not Classified
Special Input 4	47 (2F)	95 (5F)	143 (8F)	191 (BF)	239 (EF)	0	Not Classified

## 7.5 Device Variables (cont.)

The available device variable codes that can currently be published are tabulated in Table 15 below.

The Device Variable Family Code for all measurements is 250, "Not Used." Device variable numbers and unit types are listed in this section.

Selectable Unit Types are restricted in such a way that each Variable Class can use only a single unit at a time. For instance, if a Volumetric Flow variable unit is changed, all subsequent Volumetric Flow variables will switch to that unit. This keeps forward and reverse internal **Sentinel LNG** units in sync with the HART variable type.

Velocity	0 (00)	48 (30)	96 (60)	144 (90)	192 (C0)	67	Velocity
Volumetric	1 (01)	49 (31)	97 (61)	145 (91)	193 (C1)	66	Volumetric Flow
FWD Total	2 (02)	50 (32)	98 (62)	146 (92)	194 (C2)	68	Volume (FWD)
REV Total	3 (03)	51 (33)	99 (63)	147 (93)	195 (C3)	68	Volume (REV)
Totl. Time	4 (04)	52 (34)	100 (64)	148 (94)	196 (C4)	70	Time
Mass Flow						72	Mass Flow
FWD Mass						71	Mass (FWD)
REV Mass						71	Mass (REV)
EnergyRate						79	Power
FWD Energy						77	Energy (FWD)
REV Energy						77	Energy (REV)
Reynolds #		59 (3B)	107 (6B)	155 (9B)	203 (CB)	0	Not Classified
K(RE)		60 (3C)	108 (6C)	156 (9C)	204 (CC)	0	Not Classified
CTL	13 (0D)					0	Not Classified
CPL	14 (0E)					0	Not Classified
CTPL	15 (0F)					0	Not Classified
Soundspeed	16 (10)	64 (40)	112 (70)	160 (A0)	208 (D0)	67	Velocity
Up Transit		65 (41)	113 (71)	161 (A1)	209 (D1)	70	Time
Dn Transit		66 (42)	114 (72)	162 (A2)	210 (D2)	70	Time
DeltaT		67 (43)	115 (73)	163 (A3)	211 (D3)	70	Time
Gain Up[dB]		68 (44)	116 (74)	164 (A4)	212 (D4)	0	Not Classified
Gain Dn[db]		69 (45)	117 (75)	165 (A5)	213 (D5)	0	Not Classified
Up Sig Strength		70 (46)	118 (76)	166 (A6)	214 (D6)	0	Not Classified
DN Sig Strength		71 (47)	119 (77)	167 (A7)	215 (D7)	0	Not Classified
UP DAC		72 (48)	120 (78)	168 (A8)	216 (D8)	0	Not Classified
DN DAC		73 (49)	121 (79)	169 (A9)	217 (D9)	0	Not Classified
UP Amp Discrim		74 (4A)	122 (7A)	170 (AA)	218 (DA)	0	Not Classified
DN Amp Discrim		75 (4B)	123 (7B)	171 (AB)	219 (DB)	0	Not Classified
Peak%		76 (4C)	124 (7C)	172 (AC)	220 (DC)	81	Analytical
UP Signal Q		77 (4D)	125 (7D)	173 (AD)	221 (DD)	0	Not Classified
DN Signal Q		78 (4E)	126 (7E)	174 (AE)	222 (DE)	0	Not Classified
UP +- Peak		79 (4F)	127 (7F)	175 (AF)	223 (DF)	0	Not Classified

DN +- Peak		80 (50)	128 (80)	176 (B0)	224 (E0)	0	Not Classified
UP Norm Factor		81 (51)	129 (81)	177 (B1)	225 (E1)	0	Not Classified
DN Norm Factor						0	Not Classified
Theta 3						0	Not Classified
CEEI						67	Velocity
Supply Temp	37 (25)	85 (55)	133 (85)	181 (B5)	229 (E5)	64	Temperature
Return Temp						64	Temperature
Supply-Rtn						0	Not Classified
Supply Dens	40 (28)	88 (58)	136 (88)	184 (B8)	232 (E8)	0	Not Classified
Return Dens						0	Not Classified
Delta h						0	Not Classified
Pressure Input	43 (2B)	91 (5B)	139 (8B)	187 (BB)	235 (EB)	65	Pressure
Special Input 1						0	Not Classified
Special Input 2						0	Not Classified
Special Input 3						0	Not Classified
Special Input 4						0	Not Classified

When optional API Correction is installed, the Composite Volumetric and Volume variables are mapped to standard units. The supported units are referenced in section 11. Individual channel volumetric flowrate and volume units remain actual units.

## 7.6 Dynamic Variables

Only certain device variables can be published and are listed in Table 15 above. More publishable variables may be added as the capabilities are added to the meter. Only the device variables listed in Table 15 may be assigned as primary, secondary, tertiary or quaternary variables (PV, SV, TV and QV). Certain diagnostic variables have units specific to that diagnostic. Refer to the **Sentinel LNG** for details on the use of diagnostic variables indicated by the variable class specified as "Not Classified."

## 7.7 Status Information

### 7.7.1 Device Status

Bit 4 ("More Status Available") is set whenever any failure is detected. Command #48 furnishes specific information about the failure. Refer to Section Error! Reference source not found., to the **Sentinel LNG** User's Manual and to Common Tables Specification Table 17. Due to the large number of device variables, the Non-Primary Variable Out of Limits flag bit, Table 12, section 7.4.3 HCF\_SPEC-99, is never set. Instead, monitor the Extended Device Status to determine overall device variable status.

Bit 1 ("Non-Primary variable out of limits") is set only when any of the SV, TV or QV variables are out of their respective limits. This bit is not set for variables not mapped to the SV, TV or QV.

### 7.7.2 Extended Device Status

Extended Device Code 0x01, Maintenance Required, is never set by the **Sentinel LNG**.

Code 0x02, Device Variable Alert, is set if the meter is in an alarm or warning state. Because of the complexity of meter configuration and flow computation, the SEN898 may not set Device Variable Status indicators to identify specific Device Variables as the cause of the alert. Refer to the manual for information about "flow" and "non-flow" errors.

### 7.7.3 Additional Device Status

Command 48 returns four data bytes. Error bits are cleared only when the cause is rectified. Refer to the service manual for troubleshooting information. Table 16 below shows the error bits and associated SEN898 error condition.

HART Additional Device Status		Sentinel LNG Meaning	Sentinel LNG Error Condition		Class	Device Status Bits Set
Byte	Bit	–	–	–	–	–
–	–	E0	No Error	–	good	
0	0	E1	Low Signal	Flow	error	4 & 7
0	1	E2	Soundspeed	Flow	error	4 & 7
0	2	E3	Velocity/Range	Flow	error	4 & 7
0	3	E4	Signal Quality	Flow	error	4 & 7
0	4	E5	Amplitude	Flow	error	4 & 7
0	5	E6	Cycle Skip	Flow	error	4 & 7
0	6	E7	Analog Output	IO	warning	4 & 1
0	7	E8	Supply Temperature	IO	warning	4
1	0	E9	Return Temperature	IO	warning	4
1	1	E10	not used	–	–	–
1	2	E11	not used	–	–	–
1	3	E12	not used	–	–	–
1	4	E13	Tracking AGC Settled			
1	5	E14	Tracking Seek Mode	Flow HP	error	4 & 7
1	6	E15	Active TW	Flow Lp	warning	4
1	7	E16	Totalizer	IO	warning	4
2	0	E17	Temperature Input	IO	warning	4
2	1	E18	Pressure Input	IO	warning	4
2	2	E19	Density Input	IO	warning	4
2	3	E20	Special Input	IO	warning	4
2	4	E21	API Correction	Flow LP	warning	4
2	5	E22	Degraded Performance	Flow LP	warning	4
–	–	–	–	–	–	–
3	4	E29	Stale Data	Flow	error	4 & 7
3	5	E30	Channel Off	Flow	error	4 & 7
–	–	–	–	–	–	–



## 7.8 Universal Commands

All universal commands are implemented per the HART Universal Command Specification (HCF\_SPEC-127, rev. 6.0).

The transducer serial number is not relevant to flowmeters, so a zero is returned in the first two data bytes of Command 14, Read Primary Variable Transducer Information.

## 7.9 Common-Practice Commands

### 7.9.1 Supported Common Practice Commands

Number	Function
33	Read Device Variables
34	Write Primary Variable Damping Value
35	Write Primary Variable Range Values
36	Set Primary Variable Upper Range Value
37	Set Primary Variable Lower Range Value
38	Reset Configuration Changed Flag
40	Enter/Exit Fixed Current Mode
41	Perform Self Test - restricted
42	Perform Device Reset
43	Set Primary Variable Zero
44	Write Primary Variable Units
45	Trim Loop Current Zero
46	Trim Loop Current Gain
48	Read Additional Device Status
49	Write Primary Variable Transducer Serial Number
50	Read Dynamic Variable Assignments
51	Write Dynamic Variable Assignments
52	Set Device Variable Zero
53	Write Device Variable Units
54	Read Device Variable Information
55	Write Device Damping Value
59	Write Number of Response Preambles
72	Squawk

### 7.9.1.1 Command 34 and 55 Damping Value

The variable damping value is fixed and not programmable.

### 7.9.1.2 Command 35 Units Restriction

Command 35 does not allow range to be set with units other than the current publishing units. If the units do not match the selected Primary Variable units, the response "Invalid Selection" is returned. The meter does not provide the capability to convert values between units in Command 35.

### 7.9.1.3 Command 41 Perform Self Test

Due to the complex nature of the SEN898SEN898 meter, the self-test mode is Restricted. However, the device status is constantly monitored and Command 48, Read Additional Device Status, should be used to determine the current state of the meter.

### 7.9.1.4 Command 43 Set Primary Variable Zero

Only the Totals variable can be set to Zero with this command. Any other variable that is not a Forward or Reverse Total will return Invalid Selection.

### 7.9.1.5 Command 72 Squawk Command

The Squawk function, command 72, causes the LCD backlight to flash.

### 7.9.1.6 Command 52 Set Device Variable Zero

This is the same as the Device Specific command 181: Clear Totals, if the variable specified is a Totals variable. Any totals variable specified with this command will affect all totals variables. This command does not affect variables that are not a Totals variable. Invalid selection is returned for non-totals variables.

## 7.9.2 Burst Mode Commands

The **Sentinel LNG** does not support burst mode.

## 7.9.3 Catch Device Variable Command

The **Sentinel LNG** does not support the catch device variable mechanism.

## 7.10 Device-Specific Commands

A single device specific command is implemented, Clear Totals.

### 7.10.1 Command 181 (0xB5): Clear Totals

The Clear Totals command resets the accrued values for volume, mass and energy that have flowed through the meter. The timer associated with the trio of totals is also set back to zero. All totalizers resume aggregating flow immediately after the command is executed.

The effect of this command is equivalent to Command 52, Set Variable Zero, if the command 52 device variable specified is a Totals variable, it will clear all totals.

**Note:** *The function is global. **Sentinel LNG** can be configured to use individual transducer pairs, or channels, to measure flow in separate pipes. The clear totals command will reset the volume, mass, energy and time for every channel.*

Request Data Bytes	Response Data Bytes		
None	None		
None	None		

	Code	Class	Description
Command-Specific Response Codes	0	Success	No Command-Specific Errors
	1-6		Undefined
	7	Error	In Write Protect Mode
	8-127		Undefined

## 7.11 Tables

### 7.11.1 HART Engineering Units

The unit types allowed for **Sentinel LNG** device variables in Error! Reference source not found, shown in Section Error! Reference source not found, are listed below. Unit types for device variables in Error! Reference source not found are shown, but only units from Publishable variables are listed. As publishable device variables are added, so with the corresponding units.

#### 7.11.1.1 Velocity

67	Velocity	20	feet per second
		21	meters per second

#### 7.11.1.2 Volumetric Flow

66	Volumetric Flow	130	cubic feet per hour
		15	cubic feet per minute
		26	cubic feet per second
		19	cubic meters per hour
		131	cubic meters per minute
		28	cubic meters per second
		136	gallons per hour
		16	gallons per minute
		22	gallons per second
		23	million gallons per day
		135	barrels per day
		134	barrels per hour
		132	barrels per second
		138	liters per hour
		17	liters per minute
		24	liters per second
		25	million liters per day

**7.11.1.3 Standard Volumetric Flow**

66	Volumetric Flow	185	Standard cubic feet per hour
		123	Standard cubic feet per minute
		186	Standard cubic feet per second
		184	Standard cubic feet per day
		187	Standard cubic meters per day
		188	Standard cubic meters per hour
		189	Standard cubic meters per minute
		190	Standard cubic meters per second
		178	Standard liters per hour
		179	Standard liters per minute
		180	Standard liters per second
		177	Standard liters per day

**7.11.1.4 Volume**

68	Volume (FWD)	112	cubic feet
68	Volume (REV)	43	cubic meters
		40	gallons
		41	liters
		46	barrels

**7.11.1.5 Standard Volume**

68	Volume (FWD)	168	Standard cubic feet
68	Volume (REV)	172	Standard cubic meters
		171	Standard liters

**7.11.1.6 Mass Flow**

72	Mass Flow		

**7.11.1.7 Mass**

71	Mass (FWD)		
71	Mass (REV)		

**7.11.1.8 Power**

79	Power		

**7.11.1.9 Energy**

77	Energy (FWD)		
77	Energy (REV)		

**7.11.1.10 Time**

79	Power		

**7.11.1.11 Temperature**

64	Temperature	32	Degrees Celsius
		33	Degrees Fahrenheit
		34	Degrees Rankine
		35	Kelvin

**7.11.1.12 Analytical**

81	Analytical	57	Percent

**7.12 Performance****7.12.1 Sampling Rate**

All flow rates are updated at least 10 times per second. Auxiliary inputs, like pressure and temperature probes used to refine flow calculations, are also updated at least 10 times per second.

**7.12.2 Power-Up**

The **Sentinel LNG** requires approximately 15 to 60 seconds to boot after it is energized, depending on whether the non-volatile memory is being restored from default. No HART requests are processed during initiation. The analog output will default to 4mA until the primary variable is available.

**7.12.3 Device Reset**

The **Sentinel LNG** reset performance is identical to Power-Up, described in the preceding section. The meter will always exit fixed-current mode before resuming operation.

### 7.12.4 Self-Test

The meter responds to the self-test request, but performs no additional diagnostic functions. (The meter tests for errors and reports them after each measurement cycle.) Support for command 41 is included to facilitate future implementation.

### 7.12.5 Command Response Delay

Minimum	1ms
Typical	20ms
Maximum	256ms

### 7.12.6 Busy and Delayed Response

The **Sentinel LNG** never transmits a busy response code when replying to a command. The delayed response mechanism is not implemented.

### 7.12.7 Long Messages

The data field in Command 21, Read Unique Identifier Associated with Long Tag, is the largest that the **Sentinel LNG** will receive. The message contains 32 characters (bytes). The reply to Command 21 contains the largest data field sent by the **Sentinel LNG**, 18 bytes (including the two status bytes).

### 7.12.8 Non-Volatile Memory

The meter uses nonvolatile memory to store the configuration parameters. Flow totals are also periodically cached to preserve data in case power is interrupted.

### 7.12.9 Operating Modes

Fixed current mode is implemented using Command 40. This mode is cleared by power loss or reset.

### 7.12.10 Write Protection

The meter contains two write protect switches.

### 7.12.11 Write Protect Switch

The write protect switch activates the write protect mode and will generate "In Write Protect" response when active. An LED will be lit when the write protect switch is active.

### 7.12.12 Totals Protect Switch

The Totals Protect switch is used to ensure conformity to the Measuring Instruments Directive (MID). The meter totals cannot be reset when the meter is restricted via the Totals Protect switch. An LED is lit when the Totals Protect Switch is active.

## 7.13 Capability Checklist

Manufacturer, model and revision	GE Sensing Sentinel LNG flowmeter, Rev. 1.0
Device type	Transmitter
HART revision	6.3
Device Description available	No
Number and type of sensors	1 to 4 pairs of acoustic transducers, 0 to 4 temperature or pressure sensors (for flow correction)
Number and type of actuators	0
Number and type of host side signals	One 4-20mA analog output, two optional frequency/totalizer outputs
Number of Device Variables	240
Number of Dynamic Variables	4

Mappable Dynamic Variables?	Yes
Number of common-practice commands	22
Number of device-specific commands	1
Bits of additional device status	32
Alternative operating modes?	No
Burst mode?	No
Write-protection?	Yes



## 7.14 Default Configuration

Device variable mapped to PV	Average velocity
Lower Range Value	0
Upper Range Value	100
PV Units	Feet per second
Damping time constant	NaN (not a number)
Total lock	Off (i.e., reset is enabled)
Number of response preambles	5

Refer to Chapter 3, *Operation*, for more information about factory default settings for the **Sentinel LNG**.

## 7.15 Revision History



## Chapter 8. Maintenance

### 8.1 Calibration

In the **CALIB** menu, the user can calibrate and trim the analog output and inputs and check other meter functions. This chapter also covers updating Sentinel LNG software over the RS232 interface.

Before performing calibration of the Sentinel LNG, be sure the following equipment is available:

- Current meter capable of precisely measuring 4 to 20 mA current levels
- PC with RS232 Cable and *Hyperterminal* software (available on Windows operating systems)

While following the programming instructions, refer to Figure 236 on page 217.

#### 8.1.1 Updating Sentinel LNG Instrument Software

1. To set up the RS232, connect one end of a 9-pin RS232 cable to the COM-1 serial port on a PC and the other end to Com Port I/O on terminal block TB2 on the Sentinel LNG, as described in Chapter 2, *Installation*.

**WARNING!** Use RS232 connections in Non-Hazardous areas only.

**Note:** *The RS232 cable connection is not limited to the COM-1 serial port of the PC. Connect the RS232 cable to any available RS232 serial port on the PC, and follow the same instructions as for the COM-1 port.*

2. On your PC, set up the *Hyperterminal* program.

**Note:** *The use of Hyperterminal is shown here as an example. If you are using a different communications software, see its manual for detailed instructions.*

- a. From the PC Start Menu, click *Programs/Accessories/Communications/Hyperterminal* to open the Hyperterminal window.
- b. If the call is not connected, click on *New Connection* and enter a name. Click OK.
- c. In the *Connect To* window, select COM 1 as the desired port.
- d. In the *Properties* window, set the following parameters:
  - Bits per second: 115200
  - Data bits: 8
  - Parity: None.
  - Stop Bits: 1
  - Flow control: None

### 8.1.1 Updating Sentinel LNG Instrument Software (cont.)

3. From the Sentinel LNG FACTORY menu, scroll to the Upgrade option and press [ENT] twice. The Sentinel LNG screen should appear as in Figure 221 after approximately one minute, or

Power on the Sentinel LNG, and enter ESC-R from the PC keyboard. The Sentinel LNG screen should appear as in Figure 221.

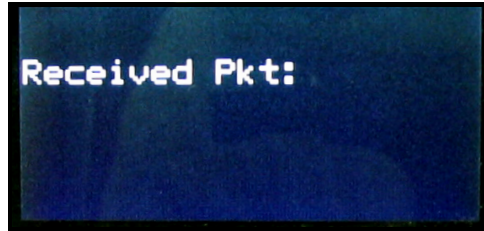

Figure 221: Sentinel LNG Screen

The Hyperterminal window on your PC should appear as follows:

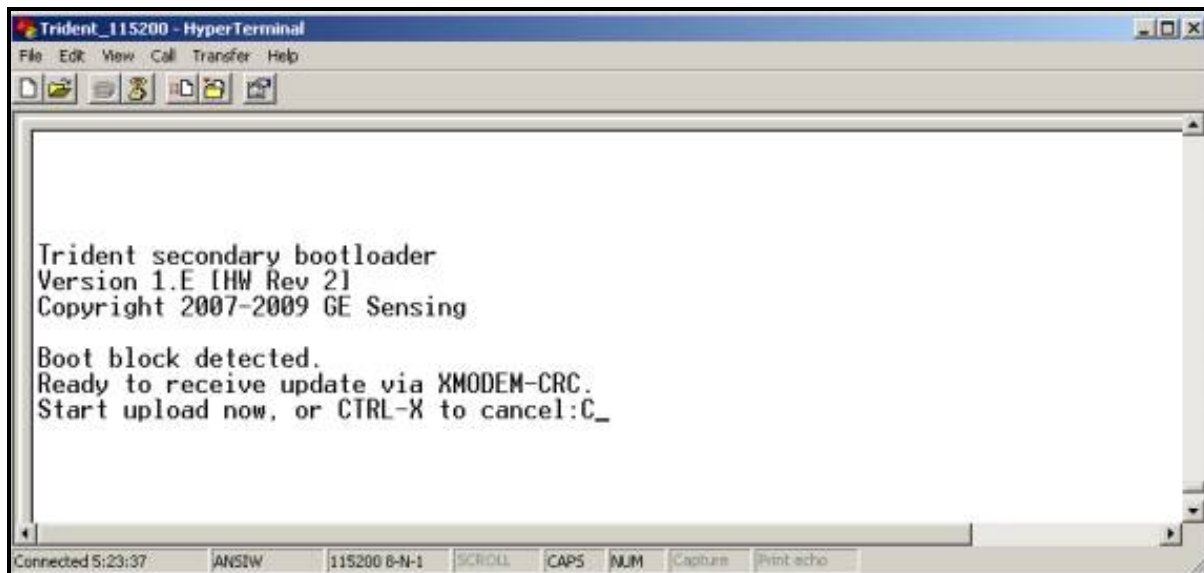

Figure 222: PC Load Request Window

Press CTRL-X on the PC keyboard to abort the process, or continue as follows to send the file.

### 8.1.1 Updating Sentinel LNG Instrument Software (cont.)

- In Hyperterminal, select *Transfer*, and then *Send File*. (The protocol should be Xmodem.) Use *Browse* to locate the file, which will have a .sim extension. Double click on this file and click the *Send* button. The screens on the Sentinel LNG (Figure 223) and on Hyperterminal (Figure 224) should both display the status of the transfer.

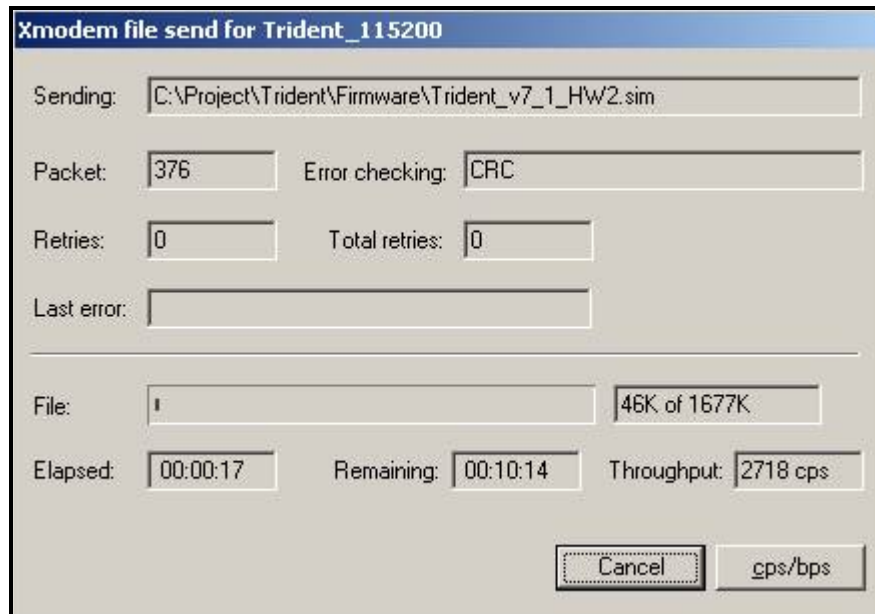

Figure 223: Sentinel LNG Transfer Status Window

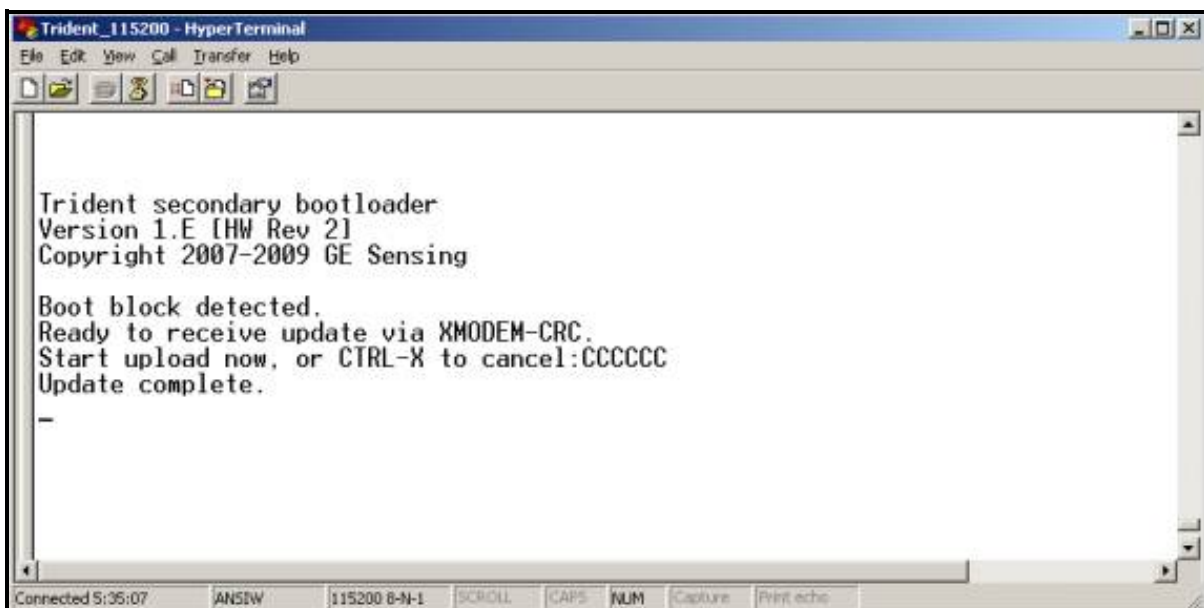

Figure 224: PC Transfer Status Window

### 8.1.1 Updating Sentinel LNG Instrument Software (cont.)

5. To ensure the Sentinel LNG operates correctly, Panametrics recommends defaulting the meter after software updates. From the Sentinel LNG Factory Menu, scroll to Default Meter and press [ENT]. Press the up arrow key [▲] and press [ENT] twice, or at power on, press and hold the [CLR-TOT] key until the following screen appears after several seconds. Release the key. Press the up arrow key [▲] to default the meter, or the down arrow key [▼] to cancel the default.

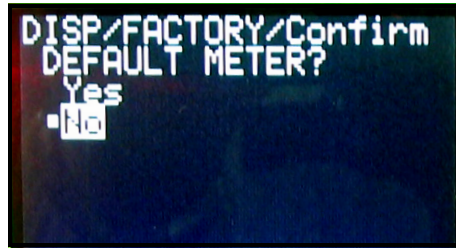

Figure 225: Default Meter? Screen

**Note:** After the Sentinel LNG has been defaulted, it restarts in the locked mode. See page 40 for instructions on unlocking the meter.

6. To check that the software has been loaded correctly, proceed to the next section.

## 8.1.2 Checking the Meter Software

1. Turn power on. The display should boot up with a typical cycling procedure.
2. To verify which version of software has been loaded:
  - a. Press **[ESC]** to enter the User Program.
  - b. Press the **[▶]** key until **FACTORY** is highlighted. Scroll to the Versions option and press **[ENT]**.
  - c. Press **[ENT]** again to enter Main. The display should appear similar to the screen below.

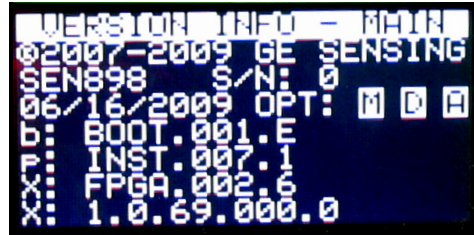

Figure 226: Software Verification Screen

### 8.1.2.1 Checking Option Card Version Information

To verify which option card version has been loaded:

1. Press **[ESC]** to enter the User Program.
2. Press the **[▶]** key until **FACTORY** is highlighted. Scroll to the Versions option and press **[ENT]**.
3. Press **[ENT]** again to enter Option Cards. The display should appear similar to the screen below.

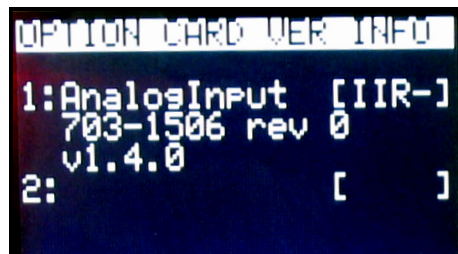

Figure 227: Option Card Verification Screen

### 8.1.3 Trimming 4–20 mA Using the Keypad

1. In the User Program, scroll to **CAL** with 4–20 Loop highlighted. Press **[ENT]**.
2. Scroll to Mode and press **[ENT]**. In the Mode window, scroll to Test[Trim] and press **[ENT]**.
3. Return to the Loop window, and scroll to Percent.
4. In the Percent window, use the arrow keys to set the percentage to 100%. Press **[ENT]**. Record the value shown on the current meter.
5. Now use the arrow keys to set the percentage to 0%. Press **[ENT]**. Record the value shown on the current meter.
6. Return to the Loop window, and scroll to Base Trim. Press **[ENT]**.
7. Use the arrow keys to enter the base trim value, the value recorded in step 5. (The loop current should now be the same as the current meter. It should read 4.0 +/-0.01 mA.) Press **[ENT]**.
8. Repeat steps 3 and 4.
9. Return to the Loop window, and scroll to Span Trim. Press **[ENT]**.
10. Use the arrow keys to enter the span trim value, the value recorded in step 4. (The loop current should now be the same as the current meter. It should read 20.0 +/-0.01 mA.) Press **[ENT]**.
11. Return to the Loop window, and scroll to Mode. Press **[ENT]**. Scroll to Normal, and press **[ENT]**.

**Note:** *The difference between “Test” and “Test [TRIM]” is that “Test” is the raw output current without the trim applied. “Test [TRIM]” is the output current with trim applied.*

## 8.2 Spare Parts

The Sentinel LNG is a high-accuracy calibrated flowmeter. Local custody transfer requirements may disallow field replacement of any parts in this flow metering system without a proper calibration of the entire system at an approved calibration facility. Check with local authorities to determine if field replacement of parts is allowed.

If fault is found with the the flowmeter electronics, the entire measurement head can be replaced to ensure hardware and firmware compatibility. The replacement part number will be as shown in *Sentinel Electronics SEN898* on page 9 of this manual. To ensure that the correct part number is ordered, provide your local Panametrics Sensing representative with the serial number of the meter, located as shown on the *Name and Specification Plate* on page 3.

If it is determined that a flow transducer has been damaged or is faulty, it may also be replaced in the field. Please consult the factory for the appropriate part number.

## 8.3 Installing Replacement Parts

The Sentinel LNG is a high-accuracy calibrated flowmeter. Local custody transfer requirements may disallow field replacement of any parts of this flow metering system without a proper calibration of the entire system at an approved calibration facility. Check with local authorities to determine if field replacement of parts is allowed.

If it is appropriate to replace any component of the flow metering system, the Panametrics Sensing field service team is trained and equipped to perform the replacement on-site. Installation of these field replaceable parts by a Panametrics Sensing field service team member will maintain the accuracy of the system and any applicable warranty. Please consult the factory to order the appropriate components and to schedule installation in the field.



## Chapter 9. Troubleshooting

### 9.1 Introduction

The Sentinel LNG flow transmitter is a reliable, easy to maintain instrument. When properly installed and operated, as described in Chapter 2, *Installation*, the meter provides accurate flow rate measurements with minimal user intervention. However, if a problem should arise with the electronics enclosure or transducers, this chapter explains how to troubleshoot the Sentinel LNG. Indications of a possible problem include:

- display of an error message on the LCD screen
- erratic flow readings
- readings of doubtful accuracy (i.e., readings that are not consistent with readings from another flow measuring device connected to the same process).

If any of the above conditions occur, proceed with the instructions presented in this chapter.

**Note:** For high electrical noise areas, it is recommended to use the CE Installation methods in Appendix B.

### 9.2 Error Codes

If a problem occurs with the electronics or transducers, a built-in error code message system greatly simplifies the troubleshooting process.

All of the possible Sentinel LNG error code messages are discussed in this chapter, along with the possible causes and the recommended actions. When an error code is generated, it will appear in the lower right corner of the LCD screen, as discussed in Chapter 3.

If an error message appears on the display screen during operation of the Sentinel LNG, refer to the appropriate section of this chapter for instructions on how to proceed. You may be asked to consult the factory. It would be very helpful to capture all of the diagnostic data and parameter information for each channel on the Data Records in Appendix C prior to calling your local sales or service center.

#### 9.2.1 E0: No Error

**Problem:** No error condition currently exists.

**Cause:** This message appears briefly to confirm that the response to another error message has corrected the problem.

**Action:** No action is required.

#### 9.2.2 E1: Low Signal

**Problem:** Poor ultrasonic signal strength or the signal exceeds the limits entered via the User Program.

**Cause:** Poor signal strength may be caused by a defective cable, a flowcell problem, a defective transducer or a problem in the electronics console. A signal that exceeds the programmed limits is probably caused by the entry of an improper value in the **Error Limits option** of the User Program.

**Action:** Using the procedures in Chapter 1, check the components listed above. Also, check the value entered into the Signal Strength **Error Limits option**, as described on page 46.

#### 9.2.3 E2: Soundspeed Error

**Problem:** The soundspeed exceeds the limits programmed in the **Error Limits option** of the User Program.

**Cause:** The error may be caused by incorrect programming, poor flow conditions or poor transducer orientation.

**Action:** Compare the measured soundspeed to tabulated nominal values for the process fluid and correct any programming errors. Refer to the sections on *Fluid and Pipe Problems* (page 202) and *Transducer Problems* (page 203) to correct any problems.

#### 9.2.4 E3: Velocity Range Error

**Problem:** The velocity exceeds the limits programmed in the **Error Limits option** of the User Program.

**Cause:** This error may be caused by the entry of improper programming data or by poor flow conditions and/or excessive turbulence.

**Action:** Make sure the actual flow rate is within the programmed limits. Also, check the value entered into the **Error Limits option**, as described on page 46. Refer to the sections on *Fluid and Pipe Problems* (page 202) and on *Transducer Problems* (page 203) to correct any problems. If this error persists, and no fluid or pipe problems appear to exist, consider enabling the Tracking Windows option.

#### 9.2.5 E4: Signal Quality Error

**Problem:** The signal quality is outside the limits programmed in the **Error Limits option** of the User Program.

**Cause:** The peak of the upstream or downstream correlation signals has fallen below the correlation peak limit, as set in the **Error Limits option on** page 46. This may be caused by a flowcell or electrical problem.

**Action:** Consult the factory.

#### 9.2.6 E5: Amplitude Error

**Problem:** The signal amplitude exceeds the limits programmed in the **Error Limits option** of the User Program.

**Cause:** Solid or liquid particulates may be present in the flowcell. The error could also be caused by poor coupling for clamp-on transducers.

**Action:** Consult the factory.

#### 9.2.7 E6: Cycle Skip, Acceleration Error

**Problem:** The acceleration exceeds the limits programmed in the **Error Limits option** of the User Program.

**Cause:** This condition is usually caused by erratic flow conditions.

**Action:** Consult the factory.

**9.2.8 E7: Analog Output Error**

**Problem:** The current setting is outside the programmed limits.

**Cause:** The calculated output value exceeds the programmed limits.

**Action:** Verify that the 4-20 loop configuration base and span settings are correct for the process. Re-range the output if necessary.

**9.2.9 E13: Settle Tracking AGC**

**Problem:** The meter is not finding the signal where it is expected.

**Cause:** The pipe may be empty or actual sound speed is outside of programmed range.

**Action:** Verify the fluid sound speed settings and fluid type.

**9.2.10 E14: Tracking Seek Mode**

**Problem:** The signal is intermittent.

**Cause:** Discontinuities in fluid characteristics such as multi-phase flow, flashing, pockets of gas, or rapidly changing fluid type make it difficult for the meter to lock in on the signal.

**Action:** Check the process conditions. If thermal insulation is present, ensure an even application to mitigate hot or cold spots.

**9.2.11 E15: Active Tw Error**

**Problem:** The active Tw measurement is outside of the expected range.

**Cause:** A transducer or cable is damaged, or a transducer needs to be recoupled.

**Action:** Ensure that the correct transducer is programmed for the meter. If this is not the fault, consult the factory.

**9.2.12 E16: Totalizer Overflow Error**

**Problem:** The totalizers are unable to keep up with the total accumulated flow signals.

**Cause:** The programmed units/pulse value is too small.

**Action:** Select a larger number of units/pulse value.

**9.2.13 E17: Temperature Input Error**

**Problem:** This message indicates a temperature input error.

**Cause:** The temperature exceeds the specified limits for the analog/RTD inputs, or no input device is connected.

**Action:** Check the temperature transmitter and the connecting cable. Recalibrate the analog/RTD inputs.

**9.2.14 E18: Pressure Input Error**

**Problem:** This message indicates a pressure input error.

**Cause:** The pressure exceeds the specified limits for the analog inputs, or no input device is connected.

**Action:** Check the pressure transmitter and the connecting cable. Recalibrate the analog input.

**9.2.15 E19: Density Input Error**

**Problem:** This message indicates a density input error.

**Cause:** The density exceeds the specified limits for the analog inputs, or no input device is connected.

**Action:** Check the density input device and the connecting cable. Recalibrate the analog input.

### 9.2.16 E20: Special Input Error

**Problem:** This message indicates a special input error.

**Cause:** The special input exceeds the specified limits for the analog inputs, or no input device is connected.

**Action:** Check the input device and the connecting cable. Recalibrate the analog input.

### 9.2.17 E21: API Error

**Problem:** This message indicates an error in the API calculations.

**Cause:** The combination of pressure, temperature, density, and/or flow inputs causes the calculation to not properly resolve.

**Action:** The specific API error can be found in the API Info section of the meter's program.

### 9.2.18 E22: Degraded Performance Error

**Problem:** The accuracy of the measurement is degraded.

**Cause:** A loss of one inner and/or outer chord measurement results in the sister inner/outer chord's measurement to be substituted, to provide a flow measurement with degraded accuracy.

**Action:** Consult the factory.

### 9.2.19 E30: Channel Disabled

**Problem:** The channel is not available.

**Cause:** The channel has been turned off.

**Action:** Enter the **PROGRAM** menu and enable the channel (see *Activating a Channel/Path (Status)* on page 43).

## 9.3 Displaying Diagnostic Parameters

The Sentinel LNG offers built-in Diagnostic Parameters to aid in the troubleshooting of transducer and/or electrical problems. To access these parameters, do the following:

1. From the display screen, press **[ESC]**.

**Note:** *If the display screen is locked, you will need to enter **[ESC]**, **[ENT]**, **[ESC]** and the security code. Refer to Unlocking and Locking the Sentinel LNG on page 40 for details.*

2. Press the **[▶]** key. The screen will highlight the channel you wish to check. Be sure the desired channel appears on the screen (or change it, as discussed in Chapter 3).

3. Press the **[▶]** key to scroll to the measurement entry in the upper right. Press **[ENT]**. Be sure Diagnostic is highlighted, and press **[ENT]**.

4. Press the **[▶]** key twice to access the units parameter. Press **[ENT]**. Scroll to the desired Diagnostic unit (as described in Table 34 on page 6) and press **[ENT]**.

5. If desired, repeat steps 1-4 for the other channel.

### 9.3 Displaying Diagnostic Parameters (cont.)

Option Bar	Description	Good	Bad
Delta-T[ns]	Displays the transit time difference between the upstream and downstream signals.	≤1 nsec	>1 nsec
Amp Up	Displays the value for the signal amplitude of the upstream transducer.	24 ± 5	<19 or >29
Amp Dn	Displays the value for the signal amplitude of the downstream transducer.	24 ± 5	<19 or >29
T Up [μs]	Displays upstream ultrasonic signal transit time.	N.A.	N.A.
T Dn [μs]	Displays downstream ultrasonic signal transit time.	N.A.	N.A.
Gain Up [dB]	Displays upstream gain in dB.	N.A.	N.A.
Gain Dn [dB]	Displays downstream gain in dB.	N.A.	N.A.
Signal Up	Displays signal strength for the upstream transducer.	50–75	<50 or >75
Signal Dn	Displays signal strength for the downstream transducer.	50–75	<50 or >75
Thresh Up [%]	Displays the value at which <b>Sentinel LNG</b> detects signal arrival time for the upstream transducer.	-100 - +100	<-100 or >100
Thresh Dn [%]	Displays value at which <b>Sentinel LNG</b> detects signal arrival time for the downstream transducer.	-100 - +100	<-100 or >100
Norm Factor	Displays the normalization factor.	0.85 - 1.0	<0.85
P# Up	Displays signal peaks for upstream transducer.	100–924	<100 or >924
P# Dn	Displays signal peaks for downstream transducer.	100–924	<100 or >924
Quality Up	Displays signal quality for upstream transducer.	≥ 1200	-400 to +400
Quality Down	Displays signal quality for downstream transducer.	≥ 1200	-400 to +400
Reynolds #	Displays the Reynolds number.	N.A.	N.A.
k(Re)	K factor, based on the Reynolds number.	N.A.	N.A.
Cycle Time [ms]	Time for the reading cycle to complete.	N.A.	N.A.
KFactor	Meter K calibration factor	0.5–2.0	<0.5 or >2.0
#Errors	Number of errors present.	0<Programmed Error Limit	≥Programmed Error Limit

## 9.4 Fluid and Pipe Problems

If preliminary troubleshooting with the *Error Code Messages* and/or the *Diagnostic Parameters* indicates a possible problem, proceed with this section. Measurement problems fall into two categories:

- fluid problems
- pipe problems.

Read the following sections carefully to determine if the problem is indeed related to the fluid or the pipe. If the instructions in this section fail to resolve the problem, contact the factory for assistance.

### 9.4.1 Fluid Problems

Most fluid-related problems result from a failure to observe the flowmeter system installation instructions, as described in Chapter 2, *Installation*. Refer to Chapter 2 to correct any installation problems.

If the physical installation of the system meets the recommended specifications, it is possible that the fluid itself may be preventing accurate flow rate measurements. The fluid being measured must meet the following requirements:

1. *The fluid must be homogeneous, single-phase, relatively clean and flowing steadily.*  
Although a low level of entrained particles may have little effect on the operation of the Sentinel LNG, excessive amounts of solid particles will absorb or disperse the ultrasound signals. This interference with the ultrasound transmissions through the fluid will cause inaccurate flow rate measurements. In addition, temperature gradients in the fluid flow may result in erratic or inaccurate flow rate readings.
2. *The fluid must not cavitate near the measurement point.*  
Fluids with a high vapor pressure may cavitate near the measurement point. This causes problems resulting from gas bubbles in the fluid. Cavitation can usually be controlled through proper system design.
3. *The fluid must not excessively attenuate ultrasound signals.*  
Some fluids, particularly those that are very viscous, readily absorb ultrasound energy. In such a case, an **E1** error code message will appear on the display screen to indicate that the ultrasonic signal strength is insufficient for reliable measurements.
4. *The fluid soundspeed must not vary excessively.*  
The Sentinel LNG will tolerate relatively large changes in the fluid soundspeed, as may be caused by variations in fluid composition and/or temperature. However, such changes must occur slowly. Rapid fluctuations in the fluid soundspeed, to a value that is considerably different from that programmed into the Sentinel LNG, will result in erratic or inaccurate flow rate readings.

**Note:** Refer to Chapter 3, Operation, to make sure that the appropriate soundspeed is programmed into the meter.

## 9.4.2 Pipe Problems

Pipe-related problems may result from improper choice in meter location or errors in programming. The following may result in problematic installations:

1. *The collection of material at the transducer location(s).*  
Accumulated debris at the transducer location(s) will interfere with transmission of the ultrasound signals. Choose an installation point for the meter where solid particles will not settle into the transducer ports. Refer to Chapter 2, Installation, for more details on proper installation practices.
2. *The inside of the pipe must be relatively clean.*  
Excessive build up of scale, rust or debris will change the inner dimensions of the pipe and will result in inaccuracies in the calculation of the flow from the velocity measurement.

## 9.5 Transducer Problems

The Sentinel LNG transducers are rugged, reliable devices that do not come into contact with the process fluid. An engineered epoxy with the appropriate physical and acoustic properties holds the transducer in place. If erratic or inaccurate readings can be tracked to a problem with a transducer or transducers, or if one is physically damaged, the Panametrics Sensing field service team has the appropriate methods and tools to properly replace the transducer to maintain the accuracy of your flow meter system. Consult your local representative to schedule this service.

### 9.5.1 Clamp-on Transducer Problems

In certain special applications, the SEN898 display package may be used with clamp-on transducers. This section covers these applications.

1. **INTERNAL DAMAGE:** Ultrasonic transducers consist of a ceramic "crystal" bonded to the transducer case. The bond between the crystal and the case may be damaged by extreme shock and by temperature extremes. The crystal itself can also be damaged by the same conditions. The internal wiring can be corroded or shorted if contaminants enter the transducer housing.
2. **PHYSICAL DAMAGE:** Transducers may be physically damaged by dropping them onto a hard surface or striking them against another object.

**IMPORTANT:** Transducers must be replaced in pairs. Refer to Chapter 3, Operation, to program the new transducer data into the meter.

3. **CYCLE SKIP CONDITION:** A cycle skip is usually caused by a distorted or altered signal due to unusual fluid disturbances.

Contact the factory if you cannot solve a transducer-related problem.

## 9.6 Audit Trail

The Sentinel LCT tracks all changes to the programming, meter status (power on, power off), error status, date/time changes, etc.

### 9.6.1 Audit Log

The Sentinel LCT's Audit Log will record system activity to a human readable log and store it in persistent memory. The activity types that generate a log entry include instances of:

- Power On/Reset
- Parameter Change
- Alarms
- Error
- Calibration Change
- Default Meter

The use of additional formatting allows for better readability. The meter can store up to 1000 audit and/or event records. When the log becomes full, the new record will overwrite the oldest record in the Audit trail. This circular log will enable the user to always view the last 1000 records. The audit log file is downloadable using PanaLink File Reader software, and is not viewable from the meters display.

#### 9.6.1.1 Power-On/Reset

The Audit log can be used to determine the meter start or reset time. The power-on is usually the first entry in the audit log file unless it was overwritten (after 1000 entries).

#### 9.6.1.2 Parameter Change

The audit log will monitor all parameters which may have an impact on the flow measurement and will record changes to them with the following fields:

- Event/Record Number (Rec No.)
- Date (mm/dd/yyyy)
- Time (hh:mm:ss)
- Source
- Parameter Identification Number
- Parameter Name
- User Level- Authentication (Auth)
- Old Value
- New Value



## 9.6.1 Audit Log (cont.)

### 9.6.1.3 Alarms

The Audit log will monitor and record the alarms with following information:

- Event/Record Number
- Date (mm/dd/yyyy)
- Time (hh:mm:ss)
- Alarm ID
- Alarm Status

### 9.6.1.4 Error

The error event will be recorded in the audit log file whenever the meter switches from a “No Error” state to “Error” state or vice versa. The Error record contains:

- Event/Record Number
- Date (mm/dd/yyyy)
- Time (hh:mm:ss)
- Error Source
- Error Number
- Previous Error
- Current Error

### 9.6.1.5 Calibration

Any calibration change needs to be notified to the user and is hence logged in the audit log file. For example, an option card changed might affect the calibration in which case the following will form a record:

- Event/Record Number
- Date (mm/dd/yyyy)
- Time (hh:mm:ss)
- Slot Number
- Event Name (Option Card)
- Previous Card Type
- Current Card Type

### 9.6.1.6 Default Meter

When a user defaults the meter (option enabled only for authenticated users, For Ex. Service) or a corruption that might lead to meter parameters to be defaulted occurs, an event is logged. Following is the information logged.

- Event/Record Number
- Date (mm/dd/yyyy)
- Time (hh:mm:ss)
- Event Type (User requested or Corrupted)

## 9.6.2 Reading Audit Log Records

The Sentinel LCT meter log records are read using the PanaLink File Reader software provided.

The Audit log file will be saved to the root directory where the PanaLink File Reader application resides if the user does not specify the full directory path in the “Save To Disc File”. On clicking the “Retrieve Data” button the Audit log file residing in the meter can be read. To store the data in the specified file in the PC, click on the “Store Data” button. A screen-shot of the PanaLink File Reader Application is provided below.

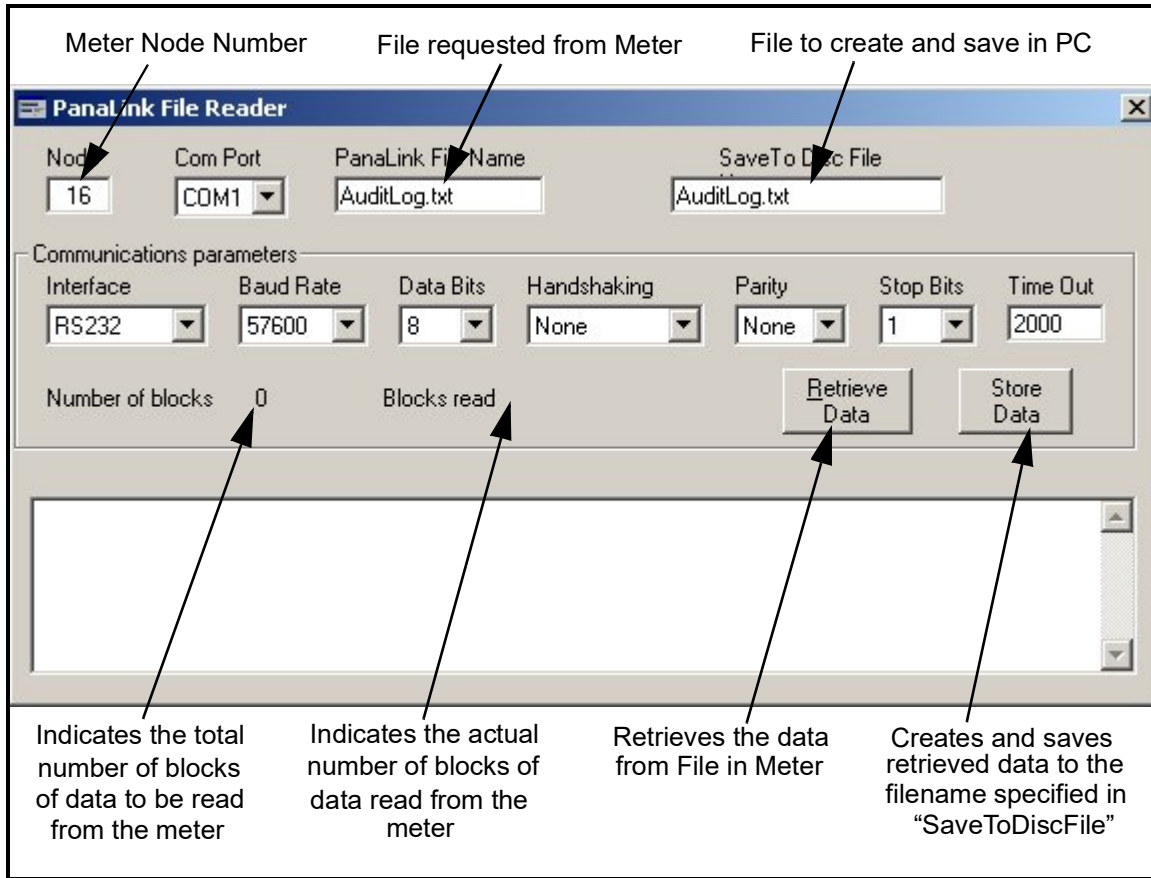

Figure 228: PanaLink File Reader

### 9.6.3 Formatting and Viewing Log Records

The log records have neatly formatted columns for easy and better readability. The record types mentioned in *Audit Log*, beginning on page 204, may contain irrelevant (not applicable) column values that are represented with '---' in the corresponding column. The Audit log file contains the following columns:

Rec #	Date	Time	Source	ID	Name	Auth.	Old	New
1	12/11/2008	2:13:19	Meter	---	Power	---	---	Power-On
2	12/11/2008	2:13:22	---	1	Alarm	---	---	Tripped

For example, a parameter change will be logged in as shown below:

Rec #	Date	Time	Source	ID	Parameter Name	Auth.	Old	New
1	12/11/2008	5:11:58	1	25798	RxWWidth	0	1024	2048

The Audit log file is formatted such that the user has the flexibility of viewing or saving the log file as either a Text file or a Microsoft Excel file. In order to get the full benefits of the Audit trail feature, we recommend using the Microsoft Excel file. This option, however, is available only if Microsoft® Excel® 2000 or later is installed on the PC.

## 9.7 Uncertainty in Flow Rate for a Non-Insulated Meter

Dimensional compensation considers the effect on the geometrical dimensions of the meter due to the material thermal expansion or contraction. The fluid temperature inside of the meter is measured and used for this purpose. Under severe ambient conditions, eg.  $-40^{\circ}\text{C}$  in winter, the fluid temperature can be very different, by up to  $10^{\circ}\text{C}$ , from the actual wall temperature. This will cause about a 0.04% error in the flow rate measured. The Figure 229 below indicates that the errors increase as the temperature difference between the fluid and the ambient for both insulated and non-insulated meters. For non-insulated meters at large temperature differences, the error is about one order higher than that for insulated meters. Therefore for applications in severe weather conditions, it is recommended to insulate the meter to ensure the meter accuracy.

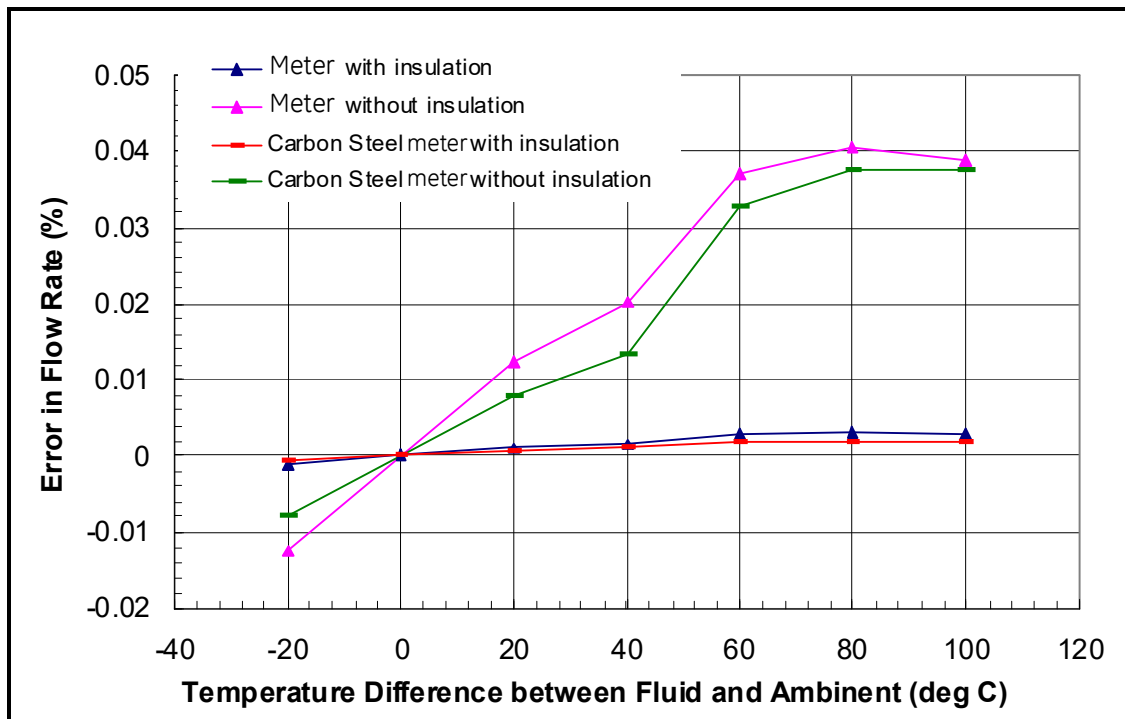

Figure 229: Example of Flow Error at Various Temperature Differences



---

## Appendix A. Menu Maps

This appendix includes the following Sentinel LNG procedure formats:

- Figure 230: MFG and DEV Menu Map
- Figure 231: PROG Menu Map
- Figure 232: PROG Composite Menu Map
- Figure 233: CONFIG Menu Map
- Figure 234: IO Menu Map #1
- Figure 235: IO Menu Map #2
- Figure 236: DISP, CAL, USER, and FACTORY Menu Map



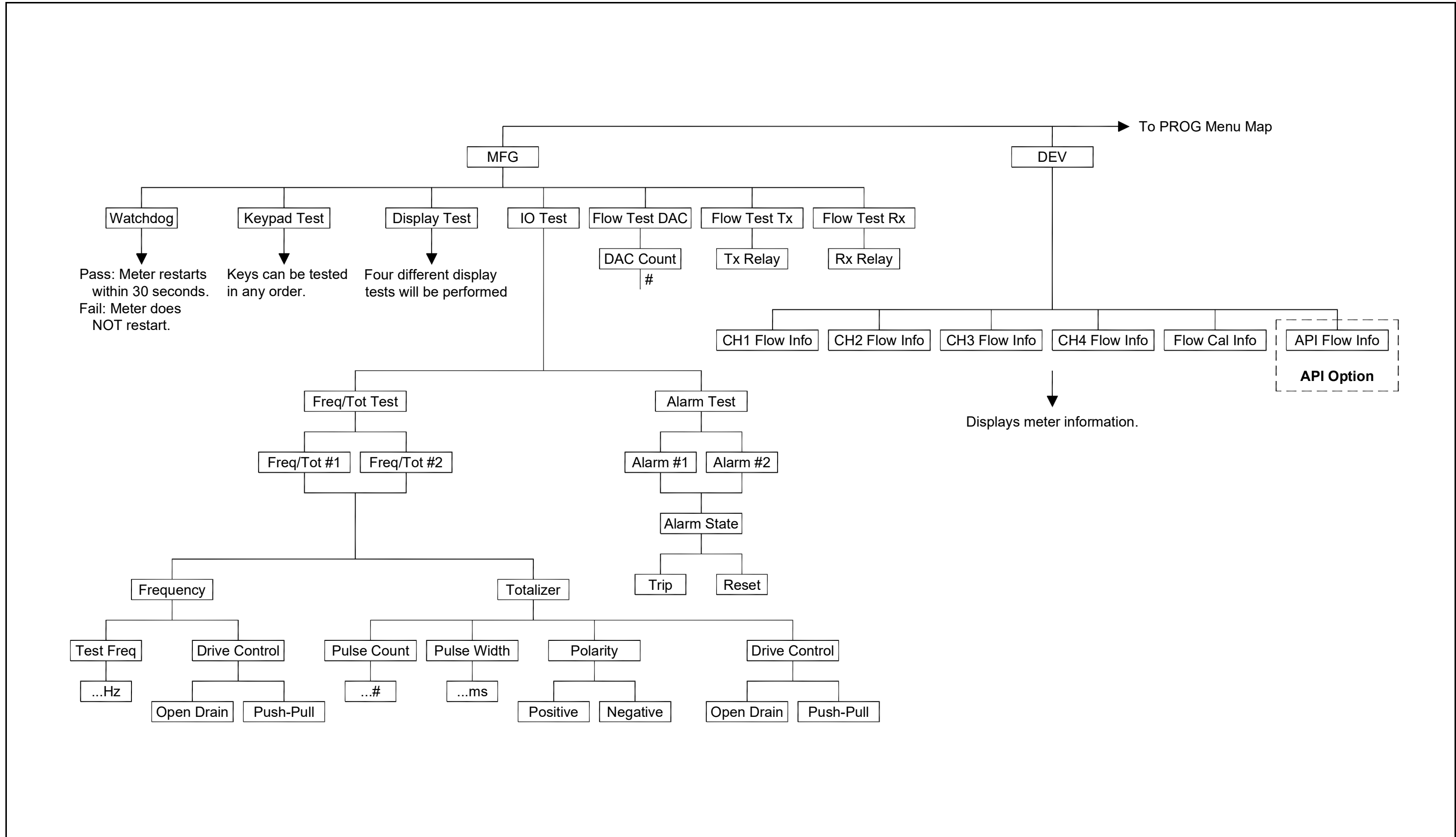

Figure 230: MFG and DEV Menu Map

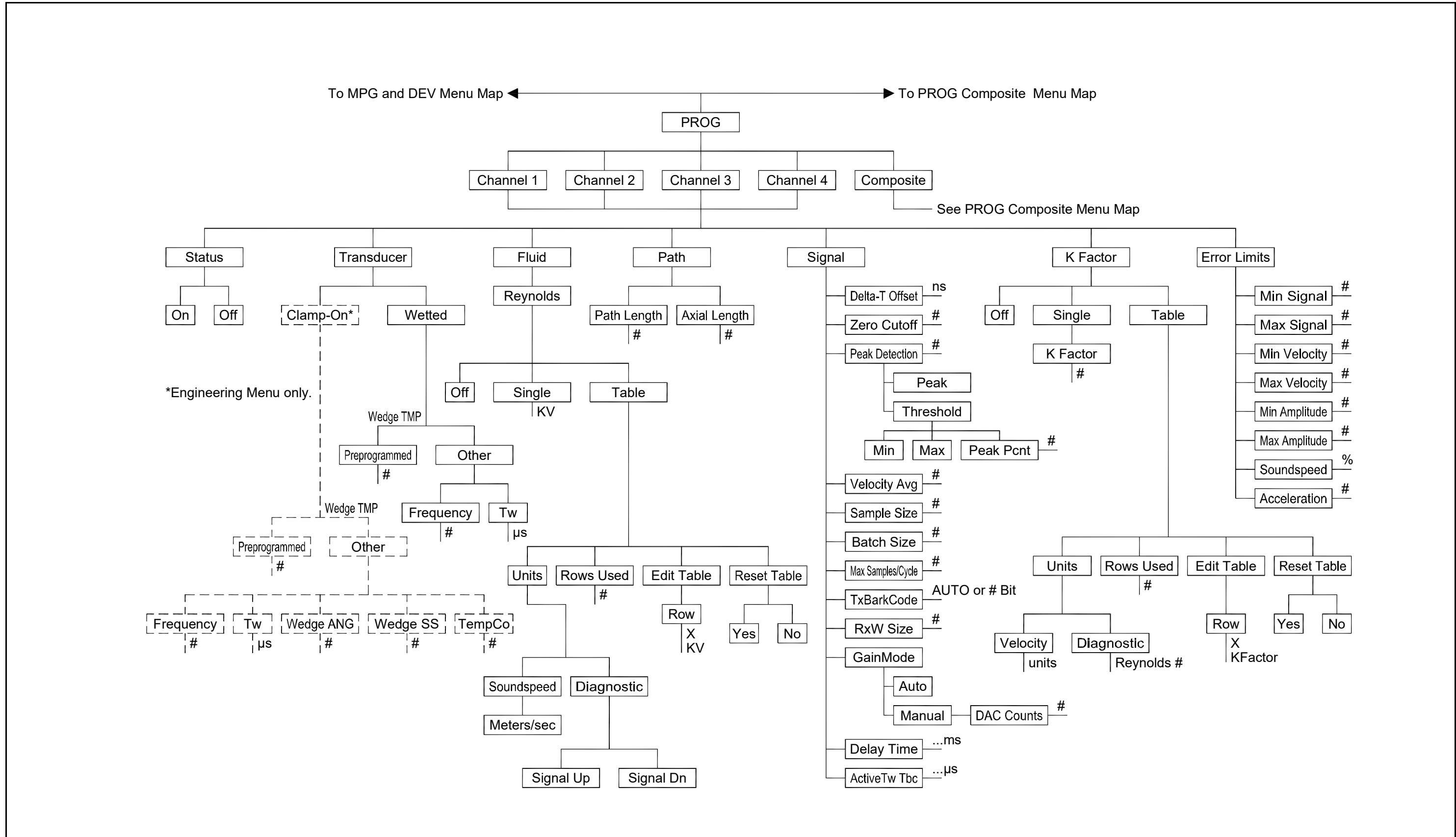

Figure 231: PROG Menu Map



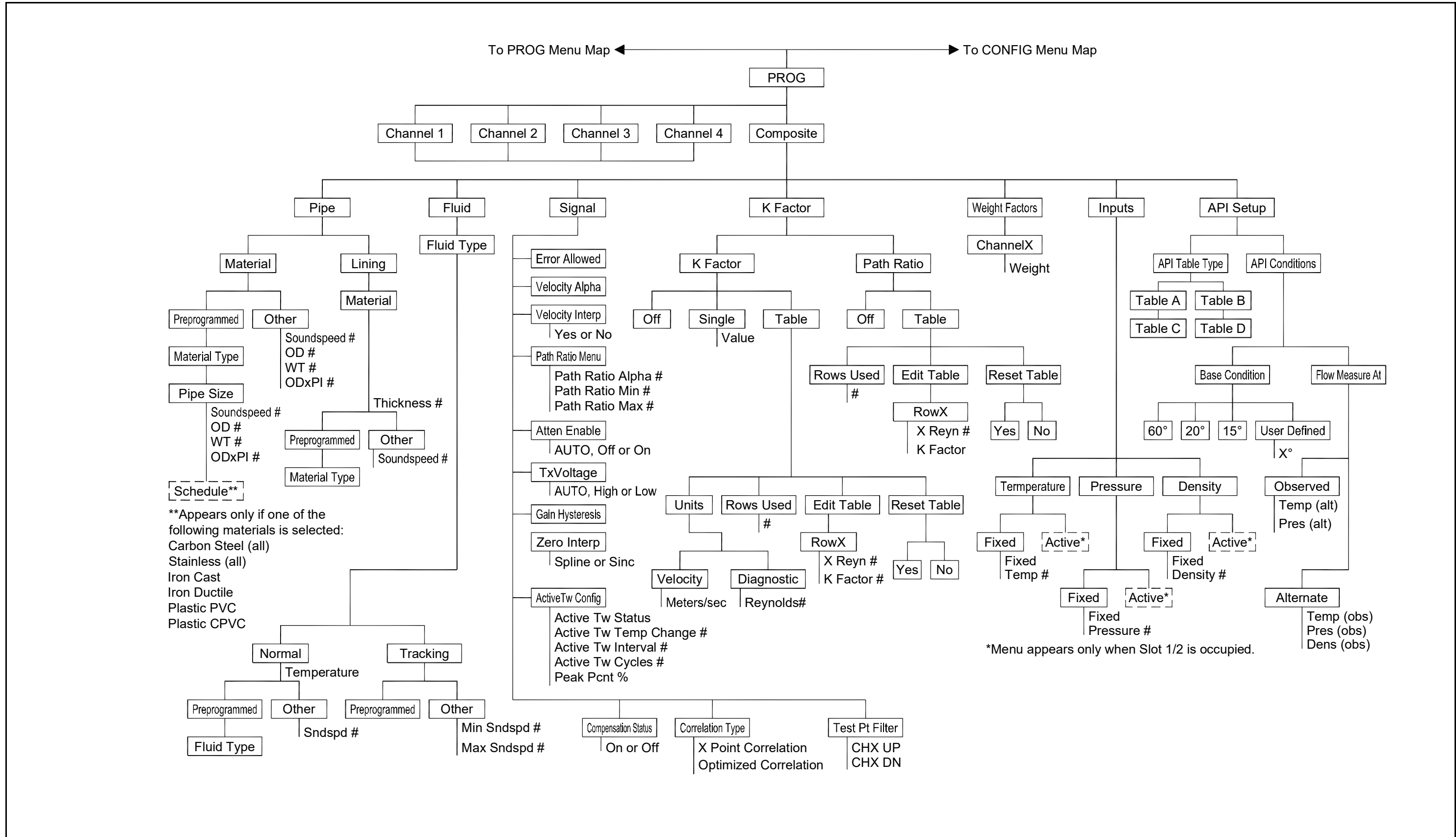

Figure 232: PROG Composite Menu Map

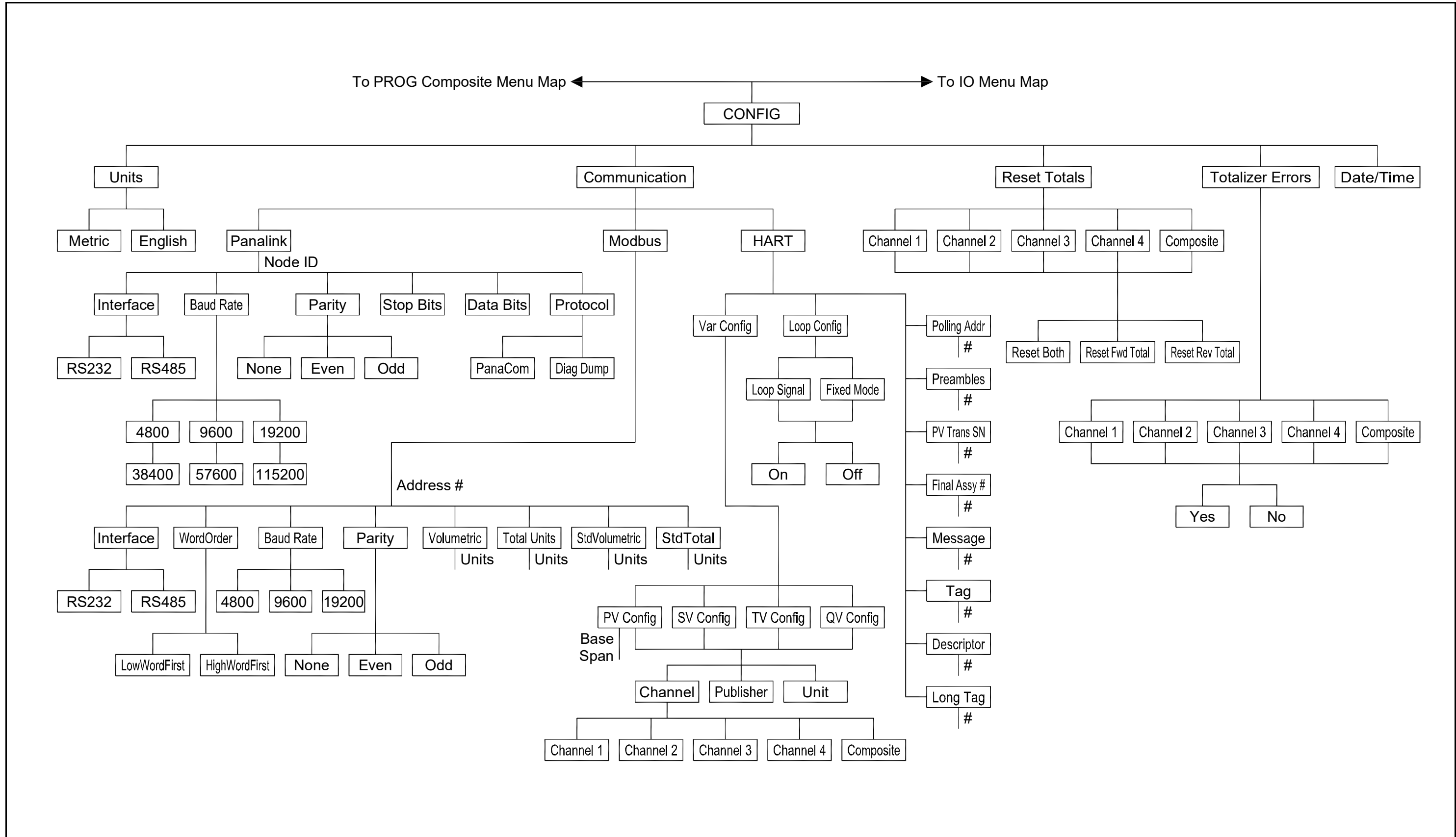

Figure 233: CONFIG Menu Map

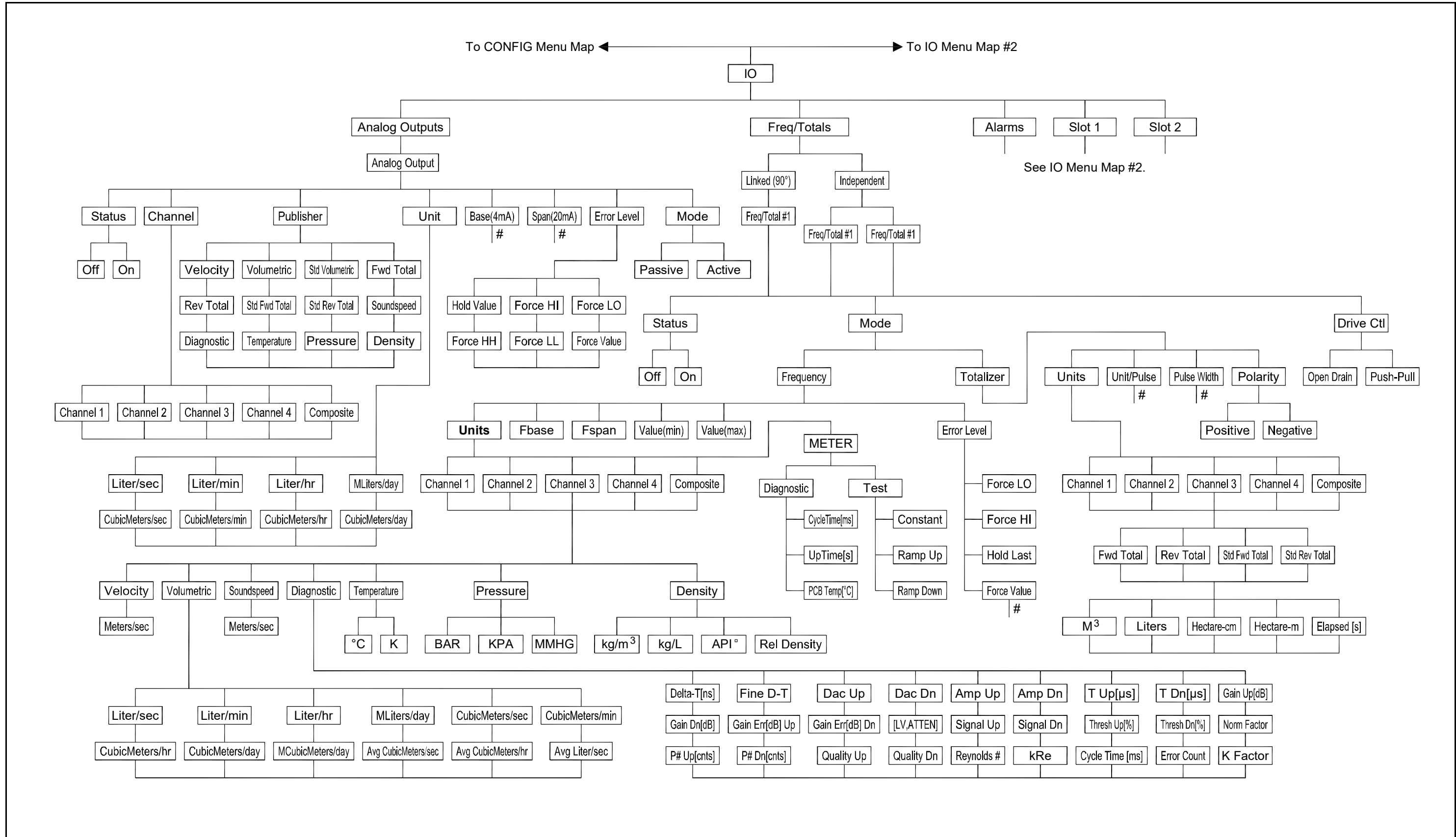

Figure 234: IO Menu Map #1

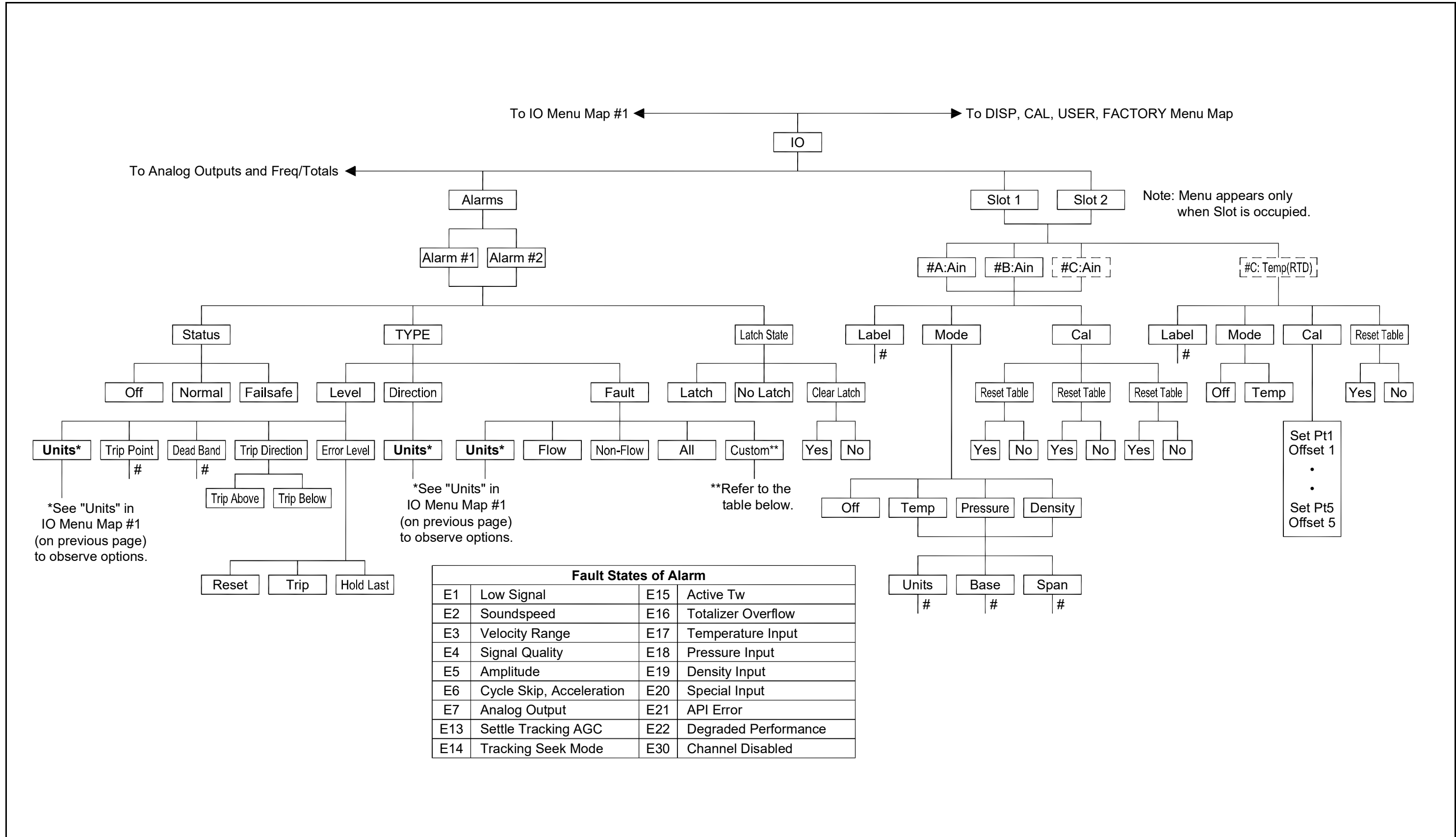

Figure 235: IO Menu Map #2

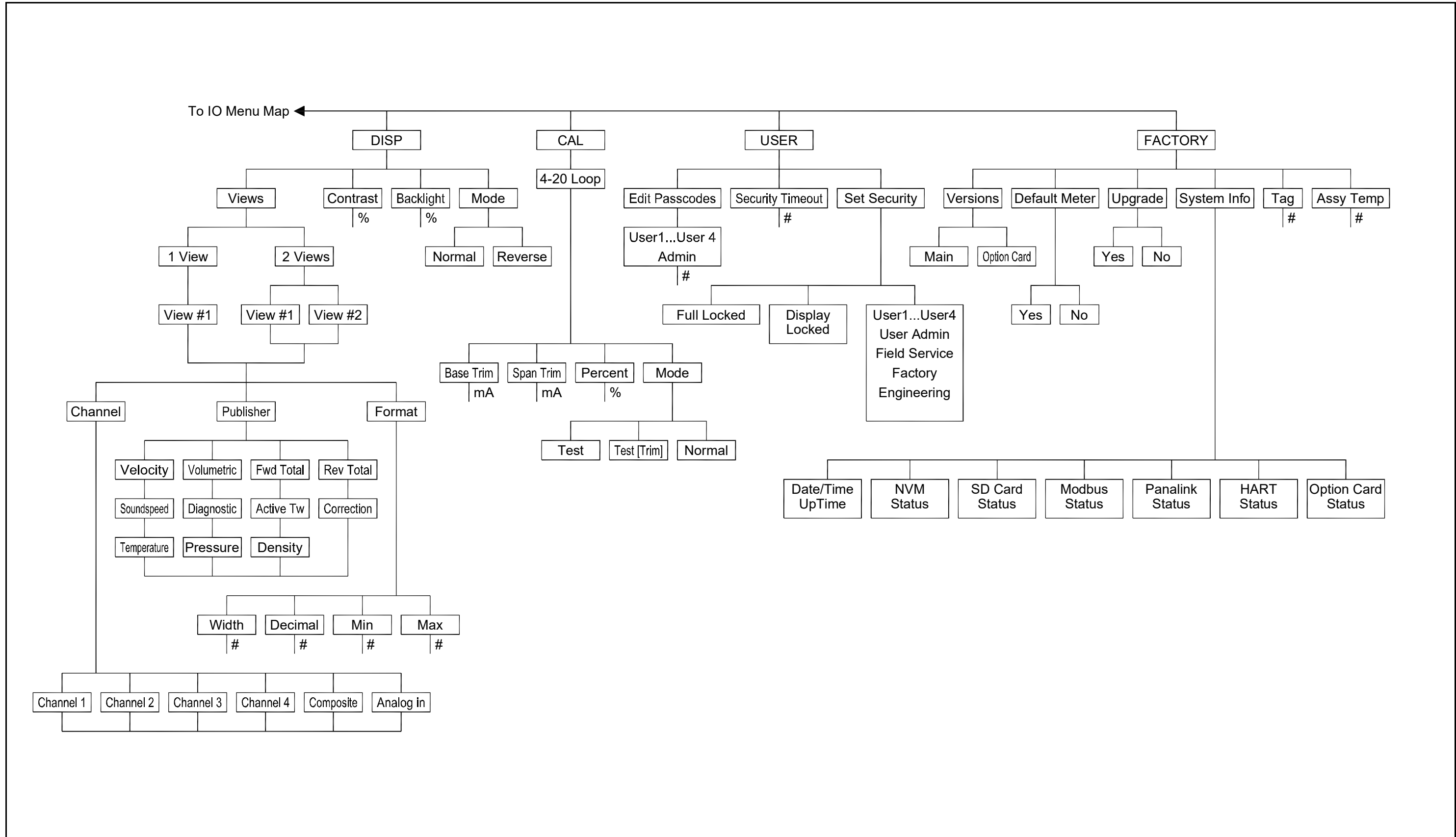

Figure 236: DISP, CAL, USER, and FACTORY Menu Map



## Appendix B. CE Mark Compliance and High Noise Areas

### B.1 Introduction

For CE Mark compliance, the Sentinel LNG flow transmitter must meet the EMC and LVD directives.

**IMPORTANT:** *CE Mark compliance is required only for units intended for use in EEC countries, and is recommended for high electrical noise areas.*

### B.2 EMC Compliance

In addition to the standard wiring requirements, the electrical connections must be shielded and grounded as in Table 5 below for EMC compliance. After all the necessary electrical connections have been made, seal any unused cable entry holes.

**Note:** *If the instructions in this appendix are followed, the unit will comply with the EMC Directive 2004/108/EC.*

**Table 5: Wiring Modifications**

Connection	Cable Type	Termination Modification
Transducer	Shielded cable	Terminate the shield using the cable glands (already done).
Power	Shielded cable	Terminate the shield to the case using the cable glands.
Shielding	Wires enclosed in a properly-grounded metal conduit do not require additional shielding.	
All Input/Output Options	Shielded cable	Terminate the shield to the case.*

**Note:** *Make sure to connect the Sentinel LNG case to the earth ground with a grounding cable, using the external ground screws found on either side of the enclosure*

*\*Terminate the cable shields to the closest screw on the bus bar inside the enclosure.*





## Appendix C. Data Records

### C.1 Site Data

After the Sentinel LNG flow transmitter has been installed, specific site data must be entered via the User Program, prior to operation. Record that information in Table 36 below.

General Information							
Model #				Serial #			
Software Vers.				Setup Date			
Channelx-Status							
Channel 1				Channel 2 (if applicable)			
Channel Status		Off <sup>1</sup> On		Channel Status		Off <sup>1</sup> On	
Channelx-Pipe Parameters							
Channel 1				Channel 2 (if applicable)			
Trans. Type		Clamp-On		Trans. Type		Clamp-On	
Transducer #				Transducer #			
Other Transducers				Other Transducers			
Wedge Temp				Wedge Temp			
Frequency (Hz)				Frequency (Hz)			
Tw (μs)				Tw (μs)			
Wedge Angle (°)				Wedge Angle (°)			
Wedge Sndspd				Wedge Sndspd			
Pipe Material				Pipe Material			
All Clamp-On Transducers				All Clamp-On Transducers			
Pipe O.D.				Pipe O.D.			
Pipe Wall				Pipe Wall			
Path Length (P)				Path Length (P)			
Axial Length (L)				Axial Length (L)			
Lining		Yes	No	Lining		Yes	No
Lining Material				Lining Material			
Lining Sndspd				Lining Sndspd			
Lining Thickness				Lining Thickness			
Track. Window.		Yes	No	Track. Window.		Yes	No
Fluid Type				Fluid Type			
Other/Sndspd				Other/Sndspd			
Reynolds Corr.		Off	Active	Reynolds Corr.		Off	Active
KV Input Sel.		Table	Static	KV Input Sel.		Table	Static
Kin. Visc.				Kin. Visc.			
Cal. Factor				Cal. Factor			
# of Traverses				# of Traverses			
Trans. Spacing				Trans. Spacing			
Channelx-Error Limits							

Channel 1			Channel 2 (if applicable)		
Min. Signal			Min. Signal		
Max. Signal			Max. Signal		
Min.Velocity			Min.Velocity		
Max. Velocity			Max. Velocity		
Min. Amplitude			Min. Amplitude		
Max. Amplitude			Max. Amplitude		
Soundspeed			Soundspeed		
Acceleration			Acceleration		

**Channelx-Signal**

Channel 1			Channel 2 (if applicable)		
Delta T Offset			Delta T Offset		
Zero Cutoff			Zero Cutoff		
# of Errors			# of Errors		
Detection	Peak	Threshold	Detection	Peak	Threshold
Min. Thresh%	N/A		Min. Thresh%	N/A	
Max. Thresh%	N/A		Max. Thresh%	N/A	
Xmit Sam. Size	N/A		Xmit Sam. Size	N/A	
Vel. Averaging			Vel. Averaging		

**Global-CONFIG**

System Units	English	Metric	Node ID	
4/20 Units			Baud Rate	
4/20 Base			Parity	
4/20 Span			Stop Bits	
Error Level			Data Bits	

**Channelx-Display**

Channel 1		Channel 2 (if applicable)	
Vol. Units		Vol. Units	
Totalizer Units		Totalizer Units	

**Channelx- KFACTOR Table**

K-Factor Table			K-Factor Table		
Channel 1			Channel 2 (if applicable)		
K-Factor Row #	Velocity	K Factor	K-Factor Row #	Velocity	K Factor
1			1		
2			2		
3			3		
4			4		
5			5		
6			6		
7			7		

**Channelx- KFACTOR Table (cont.)**

8			8		
---	--	--	---	--	--

9		
10		
11		
12		
13		
14		
15		
16		
17		
18		
19		
20		

9		
10		
11		
12		
13		
14		
15		
16		
17		
18		
19		
20		

**Channelx- Reynolds Number Table**

Channel 1			Channel 2 (if applicable)		
Reynolds Row #	Units	kRe	K-Factor Row #	Units	kRe
1			1		
2			2		
3			3		
4			4		
5			5		
6			6		
7			7		
8			8		
9			9		
10			10		
11			11		
12			12		
13			13		
14			14		
15			15		
16			16		
17			17		
18			18		
19			19		
20			20		







After a successful initial installation of the Sentinel LCT and whenever any system malfunction is noticed, the values for the diagnostic parameters should be entered in Table 38 below.

Channel 1		Channel 2		Channel 3		Channel 4	

All of this information can be found on the Flow Info pages under the DEV Menu, Modbus or by using Panaview.





<b>A</b>		<b>E</b>	
Acceleration		Electrical Connections	
Limit	46	CE Mark Compliance	219
Acceleration Error, E6	198	See Wiring	
Active Tw Error, E15	199	Error	
Advantages	1	Limits, Entering	46
Alarm Relay, Fail-Safe Operation	25	Error Code	
Amplitude		E0, No Error	197
Maximum	46	E1, Low Signal	197
Minimum	46	E13, Settle Tracking AGC	199
Amplitude Error, E5	198	E14, Tracking Seek Mode	199
Analog Inputs	26	E15, Active Tw Error	199
Connecting	26	E16, Totalizer Overflow Error	199
Pin Assignments	26	E17, Temperature Input Error	199
Rating	26	E18, Pressure Input Error	199
Analog Output Error, E7	199	E19, Density Input Error	199
Analog Outputs	31	E2, Soundspeed Error	197
Connecting	31	E20, Special Input Error	200
API Error, E21	200	E21, API Error	200
Audit Log	204	E22, Degraded Performance Error	200
Formatting and Viewing Records	206	E3, Velocity Range Error	197
Reading Records	205	E30, Channel Disabled	200
Audit Trail	204	E4, Signal Quality Error	198
<b>C</b>		E5, Amplitude Error	198
CAL Menu Map	218	E6, Cycle Skip, Acceleration Error	198
Calibration	196	E7, Analog Output Error	199
CE Mark Compliance	219	<b>F</b>	
Channel Disabled, E30	200	FACTORY Menu Map	218
Channel/Path (Status), Activating	43	Flow	
Computer Network		Bi-Directional	16
Adding Instruments	67	Non-Insulated Meter	207
Setting Up	65	Profile	5
CONFIG Menu Map	214	Uncertainty in Rate	207
Configuration, Path	4	Uni-Directional	16
Connections		Flowcell Problems	
See Part Name		Fluid	202
Cycle Skip, E6	198	Pipe	203
<b>D</b>		Fluid	
Data Record	221	Entering Data	44
Degraded Performance Error, E22	200	Physical Requirements	202
Delta T Offset	59	Problems	202
Density Input Error, E19	199	Soundspeed	47, 202
DEV Menu Map	211	Temperature	47
Diagnostic Parameters		Type	47
Displaying	200	Frequency	57
Diagnostics		Full Lock	40
Service Record	225	<b>H</b>	
Table of Values	227	Hyperterminal	191
DISP Menu Map	218	<b>I</b>	
Display		Information Paragraphs	iii
Locking	41, 42	Installation	
Unlocking	40	Bi-Directional	16
		Electrical Connections	19
		Guidelines	15
		Installing the System	17
		Mounting Flange	17
		Precautions	17
		Uni-Directional	16
		IO Menu Map #1	215
		IO Menu Map #2	216

	<b>K</b>	
K Factor, Entering.....		60
Kinematic Viscosity, Entering.....		44
	<b>L</b>	
Lining Soundspeed.....		64
Low Signal, E1.....		197
LVD, See CE Mark Compliance.....		219
	<b>M</b>	
Maximum		
Amplitude.....		46
Signal.....		46
Velocity.....		46
Menu Maps		
CAL.....		218
CONFIG.....		214
DEV.....		211
DISP.....		218
FACTORY.....		218
IO #1.....		215
IO #2.....		216
MFG.....		211
PROG.....		212
PROG Composite.....		213
USER.....		218
Meter		
Location.....		16
Properties.....		71
Security.....		71
Meter Correction (k) Factor.....		60
MFG Menu Map.....		211
Minimum		
Amplitude.....		46
Signal.....		46
Velocity.....		46
Modbus		
Connecting the Communications Line.....		24
Mounting Flange.....		17
Multipath Design.....		5
	<b>N</b>	
No Error, E0.....		197
Node ID.....		67, 69, 70
	<b>O</b>	
Operation, Principal of.....		3
	<b>P</b>	
PanaView		
Adding Instruments.....		67
Computer Setup.....		65
Meter Browser.....		65
Path Configuration.....		4
Peak Detection.....		60
Pipe		
Dimensions, Entering.....		63
Lining.....		63
Material.....		63
Parameters, Entering.....		62
Problems.....		203
Submenu.....		62
Wall Thickness.....		63
Power		
Connecting.....		12, 22
Terminal Block.....		12, 22
Precautions.....		17
Pressure Input Error, E18.....		199
Principal of Operation.....		3
Flow Profile.....		5
Multipath Design.....		5
Transducers.....		4
Transit-Time Method.....		4
Problems, Transducers.....		203
PROG Composite Menu Map.....		213
Prog Lock.....		40
PROG Menu Map.....		212
Programming.....		37
	<b>R</b>	
Return Policy.....		233
Reynolds Correction, Entering Data.....		44
RS485 Port		
See Serial Port		
	<b>S</b>	
Safety		
Auxiliary Equipment.....		iii
General Issues.....		iii
Personal Equipment.....		iii
Security		
Levels.....		71
Meter.....		71
Security Codes.....		40
Serial Port		
Connecting.....		24
Pin Assignments.....		24
Service Record.....		225
Settle Tracking AGC, E13.....		199
Setup, Minimum Required.....		65
Signal		
Maximum.....		46
Minimum.....		46
Parameters, Entering.....		44, 48, 59
Path, Entering Data.....		59
Submenu.....		44, 48, 59
Signal Quality Error, E4.....		198
Software		
Checking.....		195
Updating.....		191, 192, 193, 194
Soundspeed		
Fluid.....		47, 202
Limits.....		46
Pipe Lining.....		64
Pipe Material.....		63
Soundspeed Error, E2.....		197
Special Input Error, E20.....		200
Specifications		
Data Plate.....		3
System.....		5
Status Submenu.....		43





---

## Warranty

Each instrument manufactured by Panametrics Sensing is warranted to be free from defects in material and workmanship. Liability under this warranty is limited to restoring the instrument to normal operation or replacing the instrument, at the sole discretion of Panametrics Sensing. Fuses and batteries are specifically excluded from any liability. This warranty is effective from the date of delivery to the original purchaser. If Panametrics Sensing determines that the equipment was defective, the warranty period is:

- one year from delivery for electronic or mechanical failures
- one year from delivery for sensor shelf life

If Panametrics Sensing determines that the equipment was damaged by misuse, improper installation, the use of unauthorized replacement parts, or operating conditions outside the guidelines specified by Panametrics Sensing, the repairs are not covered under this warranty.

---

**The warranties set forth herein are exclusive and are in lieu of all other warranties whether statutory, express or implied (including warranties or merchantability and fitness for a particular purpose, and warranties arising from course of dealing or usage or trade).**

---

## Return Policy

If a Panametrics Sensing instrument malfunctions within the warranty period, the following procedure must be completed:

1. Notify Panametrics Sensing, giving full details of the problem, and provide the model number and serial number of the instrument. If the nature of the problem indicates the need for factory service, Panametrics Sensing will issue a RETURN AUTHORIZATION NUMBER (RAN), and shipping instructions for the return of the instrument to a service center will be provided.
2. If Panametrics Sensing instructs you to send your instrument to a service center, it must be shipped prepaid to the authorized repair station indicated in the shipping instructions.
3. Upon receipt, Panametrics Sensing will evaluate the instrument to determine the cause of the malfunction.

Then, one of the following courses of action will then be taken:

- If the damage is covered under the terms of the warranty, the instrument will be repaired at no cost to the owner and returned.
- If Panametrics Sensing determines that the damage is not covered under the terms of the warranty, or if the warranty has expired, an estimate for the cost of the repairs at standard rates will be provided. Upon receipt of the owner's approval to proceed, the instrument will be repaired and returned.

[no content intended for this page]



## Customer Support Centers

### U.S.A.

The Boston Center  
1100 Technology Park Drive  
Billerica, MA 01821

U.S.A.

Tel: 800 833 9438 (toll-free)  
978 437 1000

E-mail: [mstechsupport@bakerhughes.com](mailto:mstechsupport@bakerhughes.com)

### Ireland

Sensing House  
Shannon Free Zone East  
Shannon, County Clare  
Ireland

Tel: +353 (0)61 470291

E-mail: [mstechsupport@bakerhughes.com](mailto:mstechsupport@bakerhughes.com)

Copyright 2021 Baker Hughes company.

This material contains one or more registered trademarks of Baker Hughes Company and its subsidiaries in one or more countries. All third-party product and company names are trademarks of their respective holders.

910-286 B

**Baker Hughes** 